



creative cables

YOUR LIGHT STYLE

February 2022



**creative
cables**

YOUR LIGHT STYLE

INDEX

SYSTEMS	9
EIVA SYSTEM	11
LUMET SYSTEM	27
FILÉ SYSTEM	35
SI4 SYSTEM	45
CREATIVE-TUBES SYSTEM	53
ROSE-ONE SYSTEM	61
FLEX SYSTEM	85
SPOSTALUCE SYSTEM	95
MAGNETICO® SYSTEM	101
SMART HOME SYSTEM	106
COMPONENTS	108
LIGHTING CABLES	110
CEILING ROSES	130
LAMP HOLDERS	148
SPOTLIGHTS	160
LAMPSHADES	164
ACCESSORIES AND FIXTURES	176
ELECTRICITY	190
BULBS	196
LAMPS	218
SINGLE PENDANT	220
SINGLE PENDANT WITH LAMPSHADE	222
MULTI-PENDANT	224
MULTI-PENDANT WITH LAMPSHADES	226
TABLE LAMPS	228
PLUG-IN LAMPS	230
CEILING AND WALL LAMPS	232
CONFIGURATOR	234
B2B SERVICES	238
DISPLAY SOLUTIONS	242
CONTACT INFORMATIONS	244



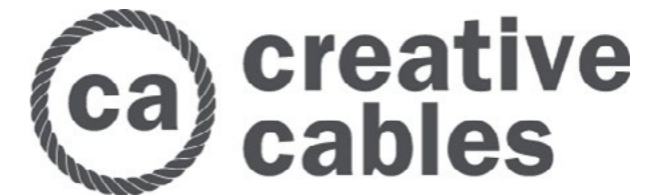

**1. We don't sell lamps:
we create them with you**

We think every lamp should be unique: a true reflection of the taste and creativity of those who buy them and enjoy them in their everyday setting.

**2. Our goal is to bring light
wherever you want**

We come up with design systems that allow you to arrange your light, moving it where you most need it.

3. Assembled or divided

Here you can find all the components you need to create your own lamp (don't worry, we have plenty of tips to help guide you through it!) or to customize an already assembled lamp with many different finishings (and in this case all you'll need to do is switch it on!)

**4. Born digital but we prefer
face-to-face**

We were born on the web and, contrary to what usually happens, we subsequently opened our stores across the world: we couldn't wait to meet our Clients in person and share a unique and special bond with them!

**5. We are people of the world
but we love our territory**

We have online and physical stores in more than 25 countries, but we also love our origins and their artisanal traditions. This is why we entrust expert Italian artisans with the production of our fabrics, ceramics and wood components.

**6. We love people that work
with light**

This is why we created exclusive services for architects, electricians, interior designers and other professionals.

7. Sturdy and Sustainable

To us sustainability means durability in time. That's why you will be able to exchange every part of your lamp by substituting them when necessary.

**8. In case you couldn't tell,
we're Italian**

Even if we picked out an English name we are still Italian and proud, and we're hoping some elements of our origins shine through.

**9. We believe in Quality and
accessible design**

For a reasonable and accessible price we try to offer beauty and the possibility of having fun by creating dazzling ideas.

**10. The content,
not the container**

We prefer to focus on the content rather than on the container: a simple packaging to highlight our colourful products!

**Custom is
our standard**

SYSTEMS

Creative-Cables systems are coherent lighting solutions designed to provide you with an answer that fits the style and functional needs you are working on. Our systems address both indoor and outdoor contexts as you simply have to lay the puzzle using the components at your disposal. As is the Creative-Cables trademark, you can of course customize, request different finishes and colours when working with our system solutions, to make sure that the system fits #YourLightStyle.



OUTDOOR



EIVA SYSTEM

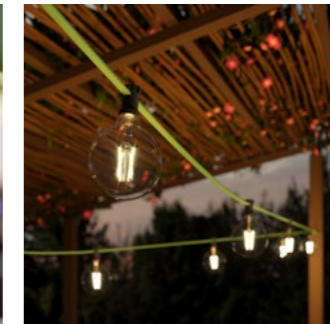

LUMET SYSTEM

27



INDOOR

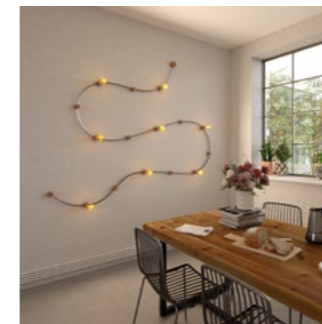

FILE' SYSTEM

35

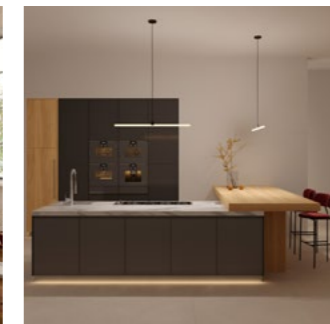

SI4 SYSTEM

45

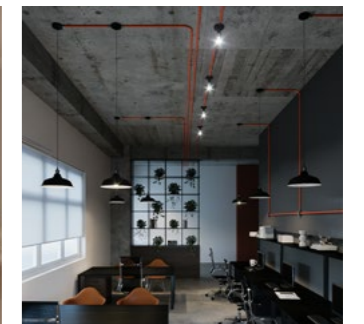

TUBES SYSTEM

53

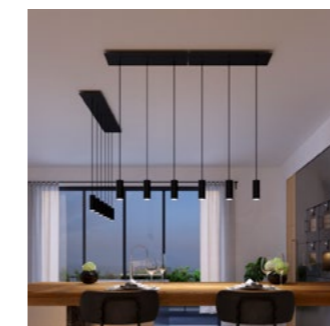

ROSE-ONE SYSTEM

61

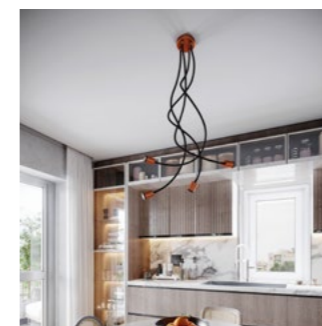

FLEX SYSTEM

85

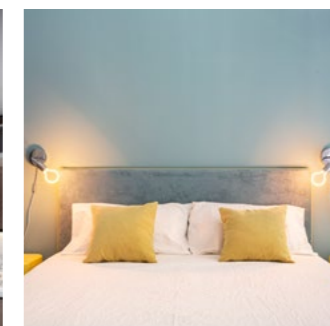

SPOSTALUCE

95



MAGNETICO® SYSTEM

101

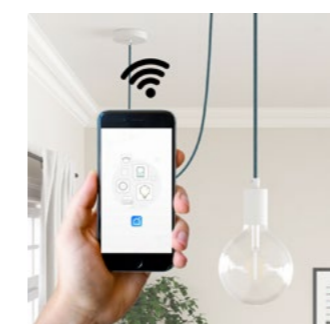

SMART HOME SYSTEM

106



The outdoor system by Creative-Cables



EIVA SYSTEM

OUTDOOR

*EIVA: the first do-it-yourself
IP65 Outdoor lighting system.*

Water has never been a natural
environment for light.
Until today.

Create your own water, rain
and storm resistant lamp with
guaranteed Creative-Cables
quality.

PATENTED SOLUTION
MADE IN ITALY

EIVA SYSTEM

IP65: Water and rain resistant

The heart of EIVA is the world's first wired E27 IP65 lamp holder: thanks to the insulating gel inside and a watertight membrane on the bulb, this lamp holder withstands rain and storms in complete safety.

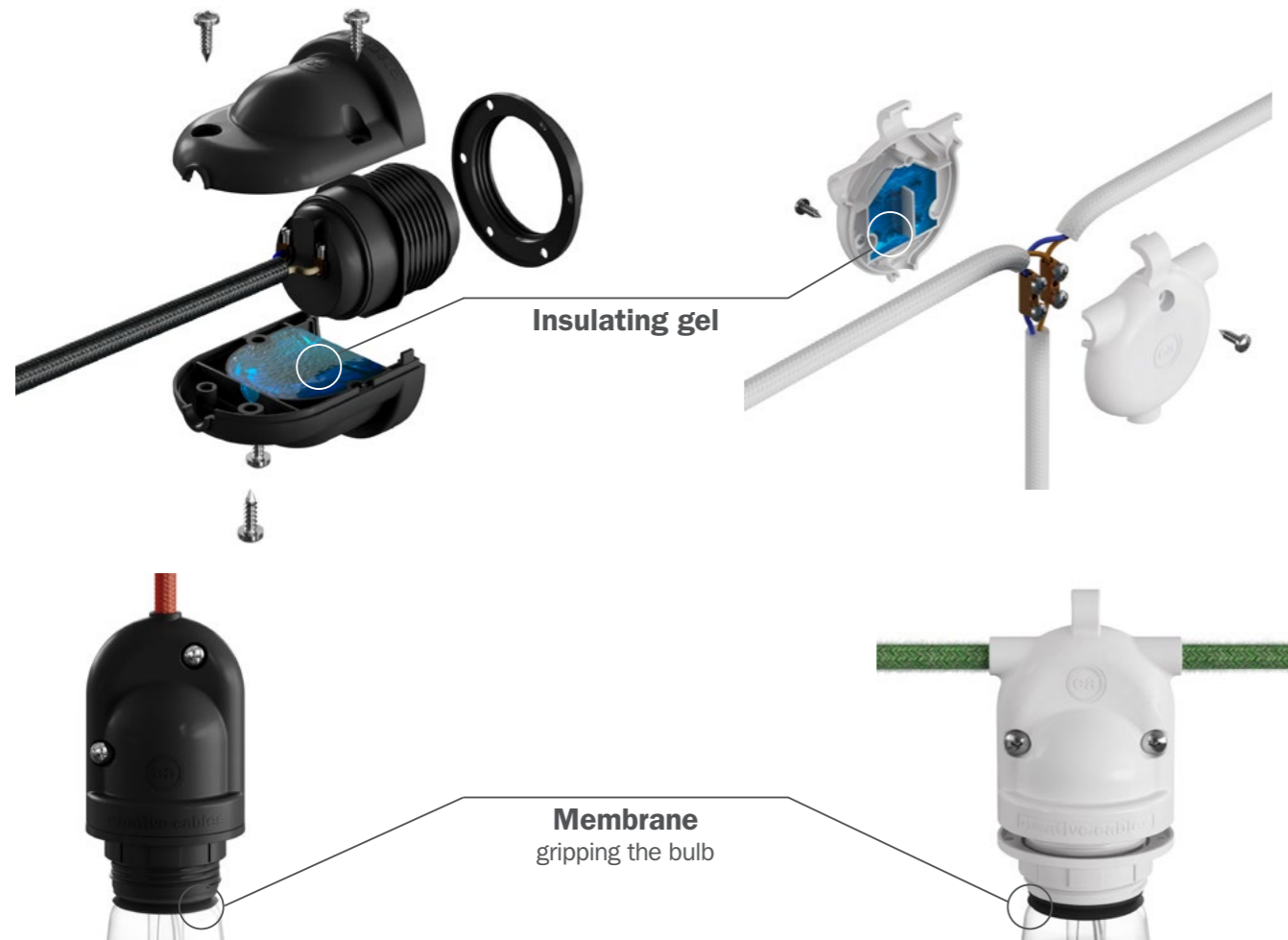

Designed for outdoor, perfect for indoor.

The EIVA lighting system is designed, engineered and patented by Creative-Cables and will allow you to illuminate outdoor spaces like gardens, patios and terraces but also as lighting solution for the bathroom, without having to worry about water splashes.

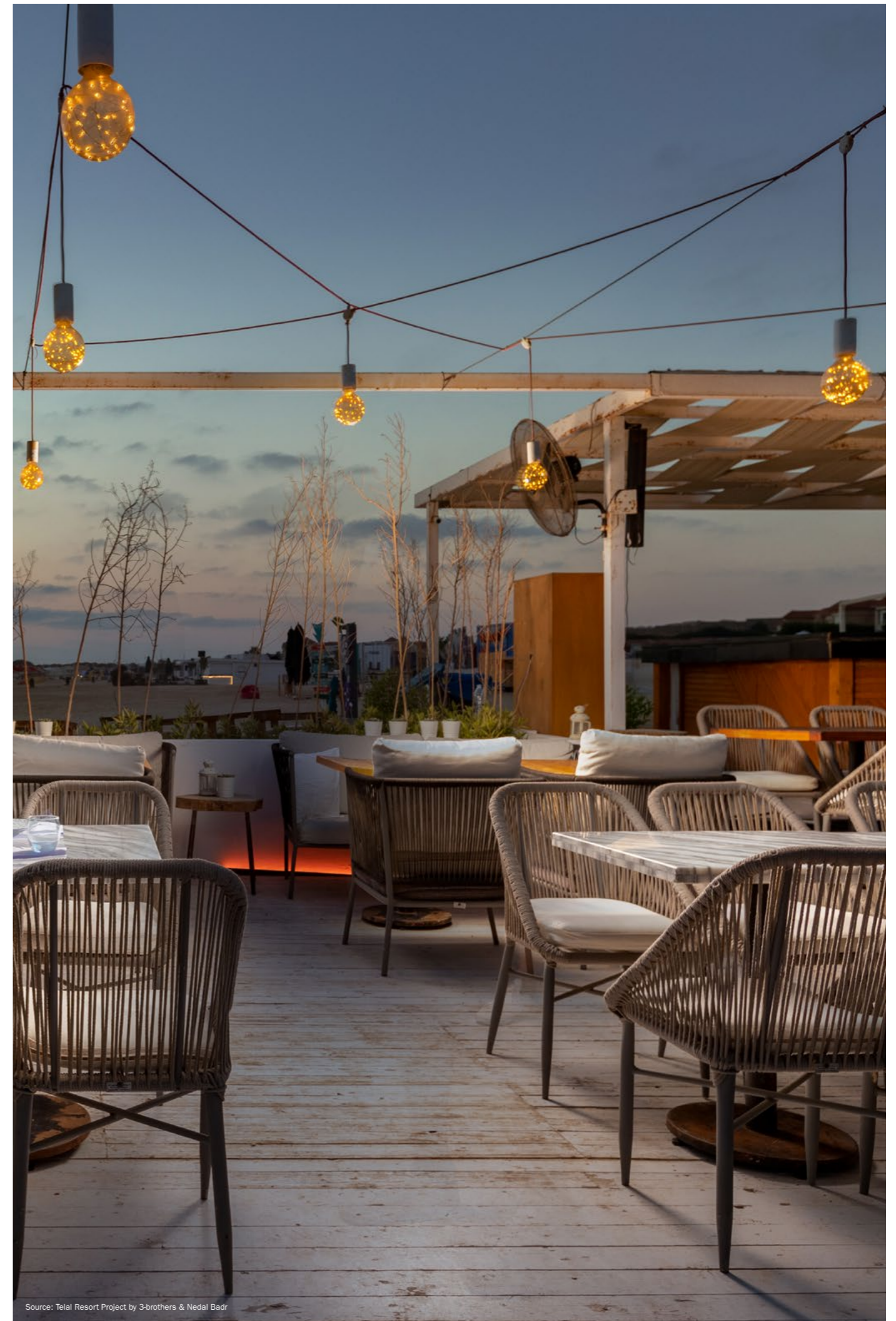

Source: Telal Resort Project by 3-brothers & Nedal Badr

EIVA USE CASES

<p>1x KEIVAROS... 2x PL27P.EIVA 2x PAM25... 2x E27 Led Bulb 1x GTP.EIVA XZ2S...</p>	<p>1x 80052 6x KEIVAELO1... 6x E27 Led Bulb 13x GTP.EIVA XZ2S...</p>	<p>1x 80052 9x PL27P.EIVA 2 9x E27 Led Bulb 7x GTP.EIVA XZ2S...</p>	<p>1x KEIVAROS... 5x PL27P.EIVA 2 5x E27 Led Bulb XZ2S...</p>
<p>1x 80052 1x KEIVAPA... 3x E27 Led Bulb 2x PL27P.EIVA 2 2x PAM13... XZ2S... 4x GTP.EIVA</p>	<p>1x KEIVAROS... 3x PL27P.EIVA 6x E27 Led Bulb 3x PAM13... 3x PL27P.EIVA 2 XZ2S... 6x GTP.EIVA</p>	<p>1x KEIVAROS... 3x KEIVAPA... 3x E27 Led Bulb 4x GTP.EIVA XZ2S...</p>	<p>1x KEIVAROS... 3x GTP.EIVA 4x PL27P.EIVA 4x E27 Led Bulb 4x PAM13... XZ2S...</p>

EIVA components

Configure your EIVA system by choosing the components that best suit your needs. IP65 single entry lamp holders can be purchased naked or with a soft touch silicone cover: perfect for single pendants or wall lamps. The multiple entry IP65 components (Eiva 2 and Eiva T) allow to create solutions with several light sources, distributed over a wide range and connected by an EIVA cable. The IP55 soft-touch silicone ceiling rose and the IP44 plug will allow you to complete your lighting using a wall connection or a socket.

Single input lamp holders



Multiple input components

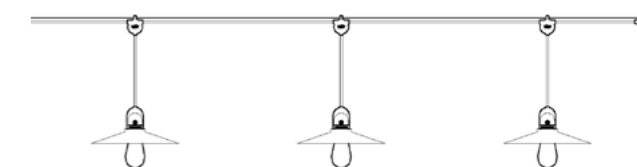
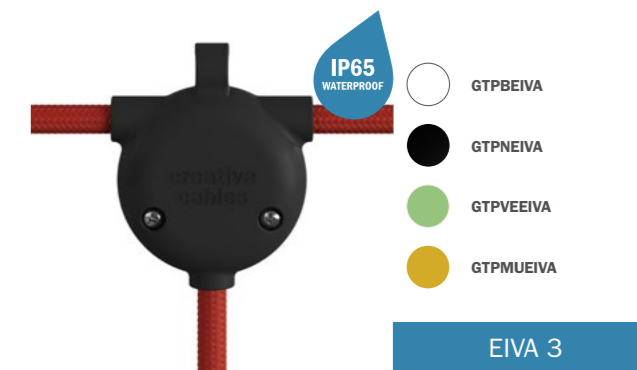

Ceiling rose and plug

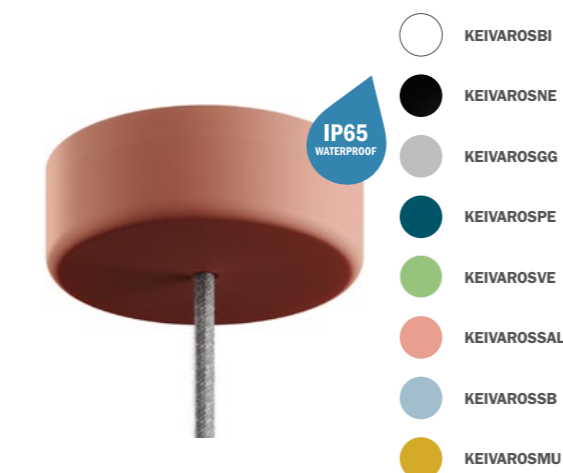

Outdoor EIVA cables

Our outdoor cables are also compatible with the EIVA system - Creative-Cables' water and rainproof outdoor lighting system.

Specifications:

H05RN-F 300/500V_{ac} 2x1mm²

Rubber sheathed flexible round IMQ-HAR Cable DOUBLE INSULATION under textile braid.

Standard reference: EN 50525-2-11, Low Voltage European Directive No. 2014/35/EU, Products meeting the safety objectives of Low Voltage Directive 2014/35/EU (Annex I). IMQ-HAR certificate No. CA01.00683, DoP No. 0015.

Diameter: 7.6mm - 2 x 1mm².

The cable is sold by the meter, multiple orders will be delivered in one piece up to a maximum of 50 meters in length.

MADE IN ITALY

IEMMEQU <HAR>
N° CA01.00683, DoP N° 0015

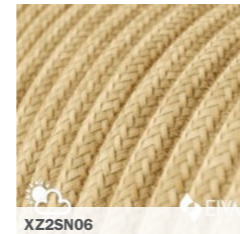
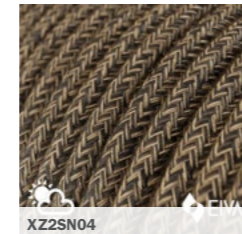
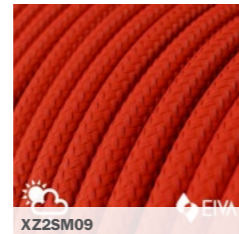
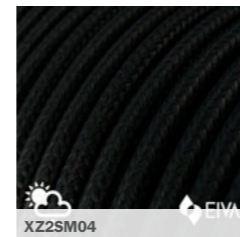

EIVA lamps

With EIVA lamps you can finally change the look of your outdoor spaces with the safety of a water resistant product which is Made in Italy. The soft touch silicone finishes and matching cable are perfect to re-create an elegant and contemporary design in your outdoor spaces, lighting pergolas and gazebos. Choose among the available versions the one that best suits your needs: with lampshade, for exposed light bulb, suspended, plug-in or wall fixed and enjoy your outdoor spaces!

Fermaluce



Max L 390mm, Max H 400mm

- adjustable**
Tilted up to 90° & rotated by 315°
- APE2TBSNEPAM05VN
 - APE2TBSNEPAM05GO
 - APE2TBSNEPAM05RA



Max L 390mm, Max H 400mm

- adjustable**
Tilted up to 90° & rotated by 315°
- APE2TBSNEPAM06VN
 - APE2TBSNEPAM06GO
 - APE2TBSNEPAM06RA



L 390mm, H 260mm

- APE2NEPAM13VNL
- APE2NEPAM13VNL
- APE2NEPAM13VRL



L 195mm, H 255mm

- APE2BI
- APE2NE
- APE2GG
- APE2PE



L 195mm, H 255mm

- APE2BI02
- APE2NE02



L 195mm, H 255mm

- APE2NEPER



Max L 205mm, Max H 255mm

- adjustable**
Tilted up to 90° & rotated by 315°
- APE2TBSBI
 - APE2TBSNE



Max L 205mm, Max H 255mm

- adjustable**
Tilted up to 90° & rotated by 315°
- APE2TBSBI02
 - APE2TBSNE02



L 195mm, H 255mm

- adjustable**
Tilted up to 90° & rotated by 315°
- APE2TBSNEPER



Source: @notrejoyeuxbazar



Suspension Lamps



-  PDEBIELO115SM01
-  PDENELO115SM04
-  PDEGGLO115SN02
-  PDEPELO115SM01









Ø max 125mm, cable length 1500mm



-  PDEBIELO150SM01
-  PDENELO150SM04
-  PDEGGLO150SN02
-  PDEPELO150SM01



Ø max 125mm, cable length 5000mm



-  PDEBI15SM01
-  PDENE15SM04
-  PDEGG15SN02
-  PDEPE15SM01
-  PDEVE15SX08
-  PDESAL15SN02
-  PDESB15SN02
-  PDEMU15SN06

Ø max 125mm, cable length 1500mm



-  PDEBI50SM01
-  PDENE50SM04
-  PDEGG50SN02
-  PDEPE50SM01
-  PDEVE50SX08
-  PDESAL50SN02
-  PDESB50SN02
-  PDEMU50SN06

Ø max 125mm, cable length 5000mm



-  PDEVEPA15SX08
-  PDESALPA15SN02
-  PDESBPA15SN02
-  PDEMUPA15SN06



Ø max 125mm, cable length 1500mm



-  PDEVEPA50SX08
-  PDESALPA50SN02
-  PDESBPA50SN02
-  PDEMUPA50SN06



Ø max 125mm, cable length 5000mm



-  PDEBIELO250SM01DDBIA
-  PDENELO250SM04DDNER
-  PDENELO250SM04DDRASOTS

Ø max 400mm, cable length 5000mm



-  PDENE50SM01PAM11VBL
-  PDENE50SM04PAM11VNL
-  PDENE50SX08PAM11VVL

Ø max 380mm, cable length 5000mm

Snake - Plug-in lamps



Ø max 60mm, cable length 5000mm

- PSEEL01BISM01
- PSEEL01NESM04
- PSEEL01GGSN02
- PSEEL01PESM01



Ø max 60mm, cable length 5000mm

- PSEPAVESX08
- PSEPASALSN02
- PSEPASBSN02
- PSEPAMUSN06



Ø max 300mm, cable length 5000mm

- PSEENESM04PAM13VNO
- PSEENESN02PAM13TIS
- PSEENESN04PAM13RAS
- PSEENESN06PAM130TS



Ø max 60mm, cable length 5000mm

- PSEENESM04





LUMET SYSTEM

OUTDOOR

*Create a unique atmosphere
with the LUMET SYSTEM.*

Light up your outdoor spaces
for a special evening with the
colorful Creative-Cables string
light systems.

LUMET SYSTEM

1

Ready-to-use lights

The Lumet System allows you to create outdoor lighting that is easy to install and dismantle. It is perfect for evenings spent outdoors with your friends, at home or on holiday!

Tailor-made

The characteristics of the cable and lamp holders mean that you can configure Lumet easily according to your needs. If your requirements change, reconfiguring the system is just as simple!

2

3

Moisture-protection

The IP44 protection classification means that you can install the Lumet System string lights in your outdoor spaces, even during the most humid evenings, and quickly take them down before each downpour.

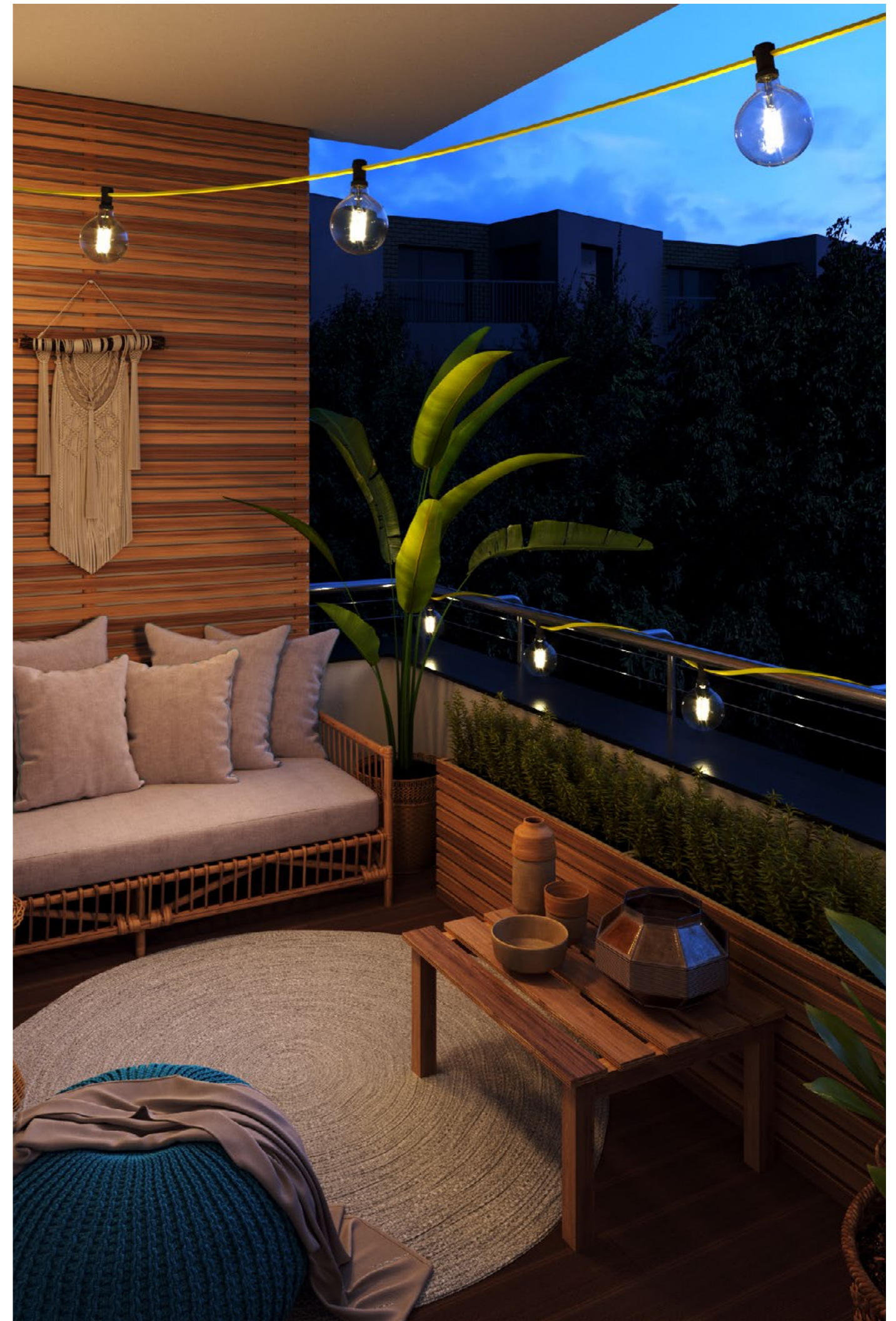
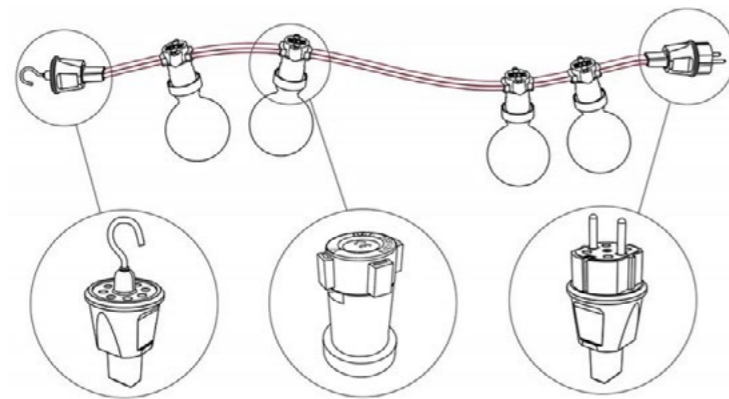

Flat cables

Specifications:

H05RNH2-F 300/500 Vac Rectangular flat shaped 2x1,5mm² cable

Standard reference: EN 50525-2-82 and IEC 60245.

The cable is sold by the meter, multiple orders will be delivered in one piece up to a maximum of 25 meters in length.



XZ15CF10



XZ15CM10



XZ15CM05



XZ15CF15



XZ15CM09



XZ15CM16



XZ15CM17



XZ15CH69



XZ15CM21



XZ15CM22



XZ15CM27



XZ15CM02



XZ15CM03



XZ15CM04



XZ15CZ04



XZ15ECM39



XZ15CZ22



XZ15CN06



XZ15CX08



XZ15ECC37

String light accessories

Schuko Plugs, hooks, junctions, lamp holders: everything you need to complete your string light and illuminate gardens, gazebos and terraces.

Plug



SPCATFRN

Hook



TERGCATN

Lampholder



PLC27TPN19

Lampholder for lampshades



PLC27PNTF

Junction box



CON01

Wal fairlead



PC10FCATM01



Lumet Complete Kits

Ready-to-use Lumet string lights are ideal for lighting outdoor spaces such as gardens, terraces, and gazebos with a solution that is simple to install and to remove. The kits offer a complete solution, available in different lengths and colors.

7,5 mt Lumet String Light Kit

This Kit is composed of 7,5m Lumet String Light of the chosen color, 5 E27 Lamp Holders, 1 Hook and 1 Schuko Plug. These string light kits can be purchased with both black or white components.



12,5 mt Lumet String Light Kit

This Kit is composed of 12,5m Lumet String Light of the chosen color, 10 E27 Lamp Holders, 1 Hook and 1 Schuko Plug. These string light kits can be purchased with both black or white components.

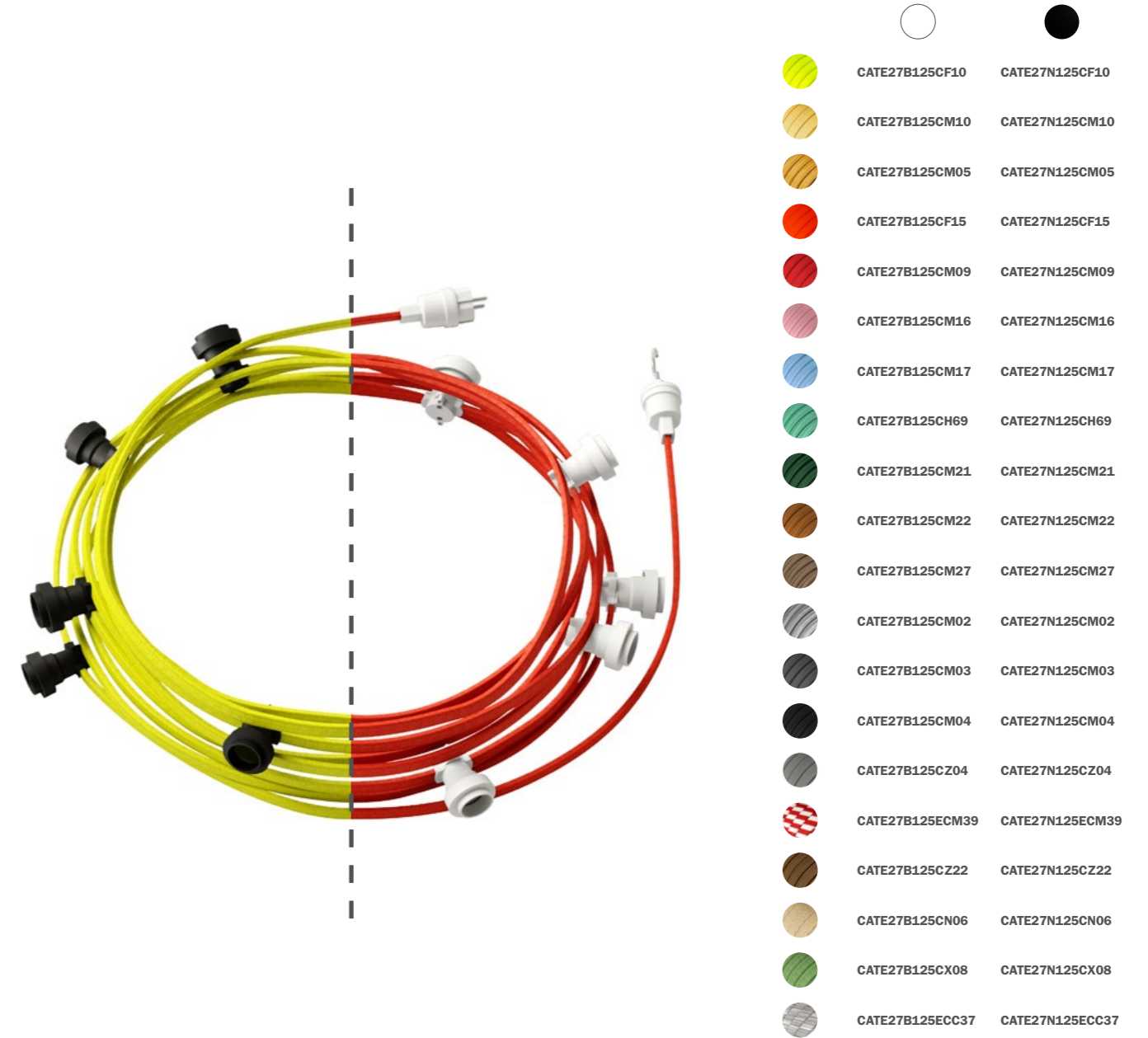



FILÉ SYSTEM

INDOOR

Decorate and light up your walls with the FILÉ SYSTEM.

Filè is the Creative-Cables system designed to create wonderful wall or ceiling lighting solutions!

Rectangular section cables covered in magnificent colours, high-quality wooden components. Made in Italy: with Filè you can build a customized and 100% Creative lighting solution!

MADE IN ITALY

FILE SYSTEM

1

Easy

Create an impressive lighting installation in just a few steps. Filé lets you forget about the difficulty and effort of wiring up a lamp holder!

Customisable

Create designs on the walls and ceilings using electrical cables available in more than 20 colors and Made in Italy wooden components. Create effective lighting, tailored to your lighting and design requirements.

2

3

Moisture-protection

The rectangular section cable features an IP44 protection classification, meaning that you can also light up bathrooms and kitchens creatively using Filé!

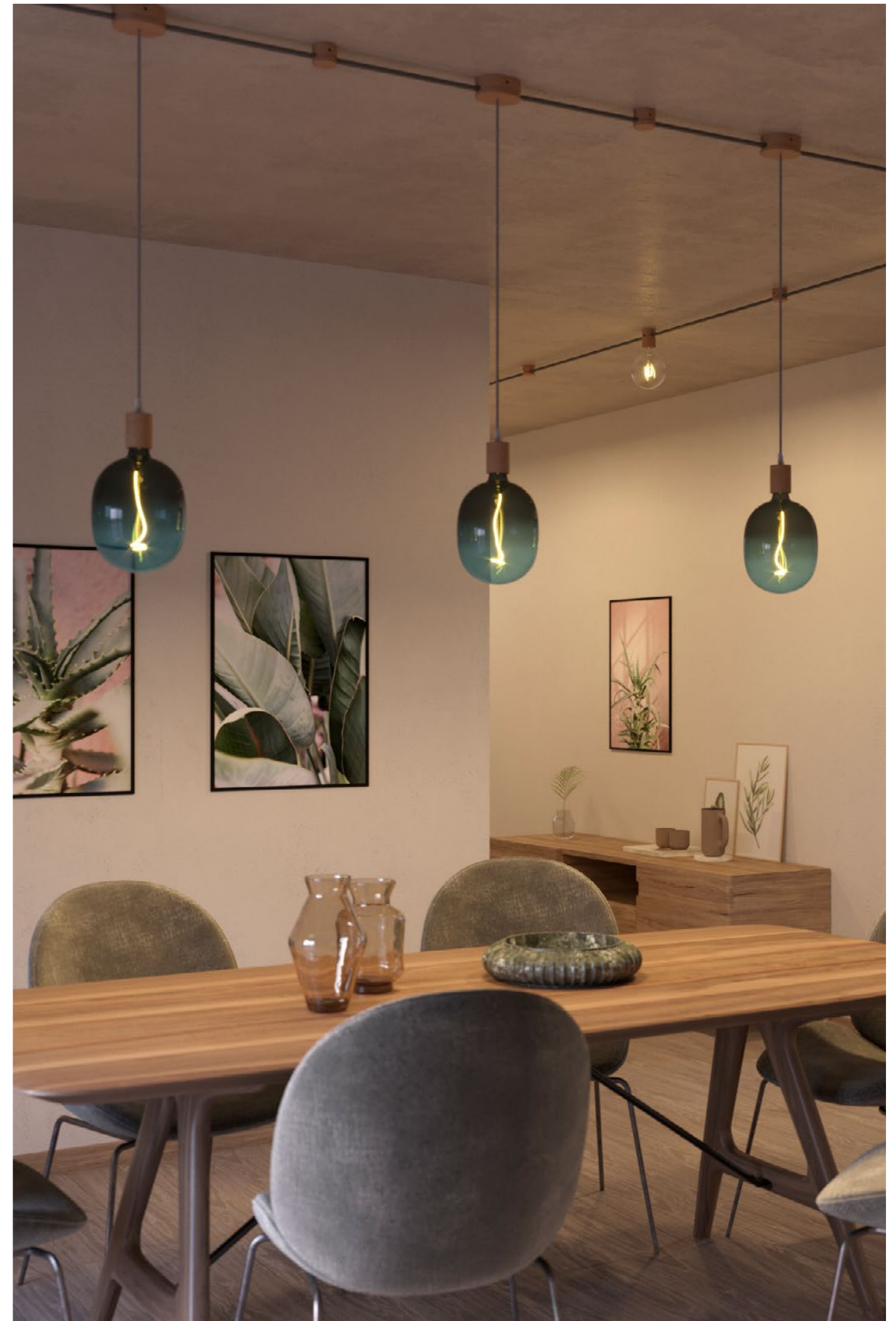
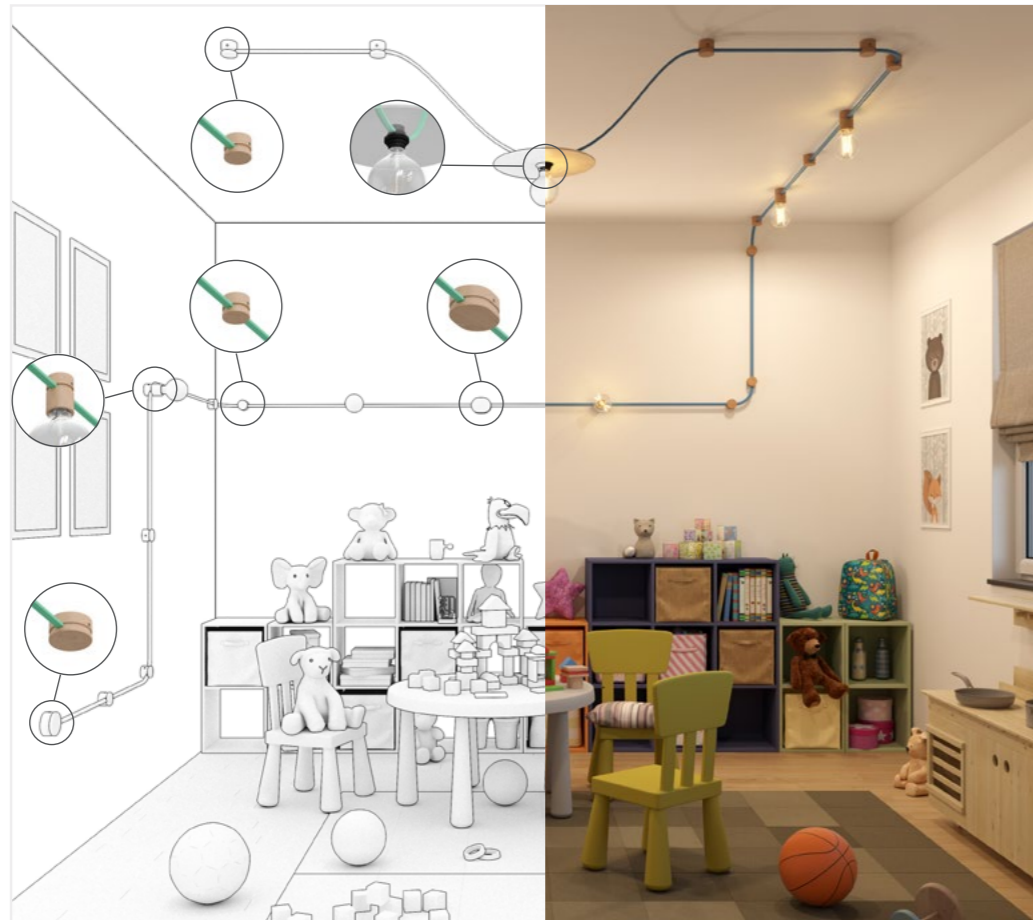
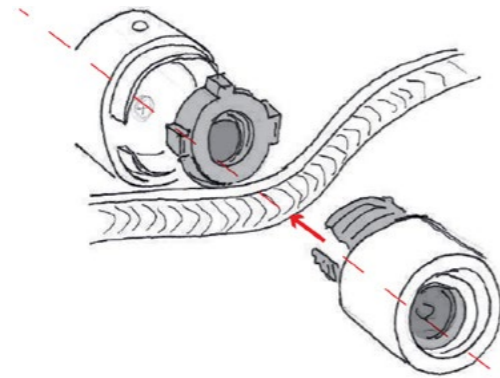

Components

All components are wooden and 100% Italian made, you can paint , varnish or leave the wood natural to suit your needs and creative projects.

Canopy



- RLCAT02
- RLCAT03
- RLCAT01

H 70mm, Ø 80mm

Lampholder



- BLCAT02
- BLCAT03
- BLCAT01

E27, H 70mm, Ø 50mm

Oval canopy

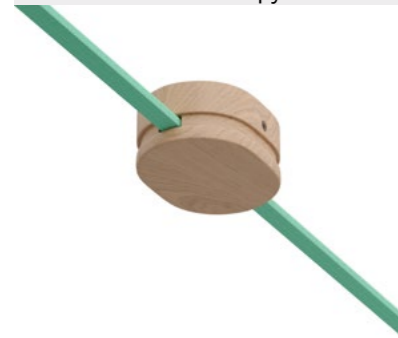

- RLCAT12
- RLCAT13
- RLCAT11

H 40mm, L 110mm, P 80mm

Wall fairlead

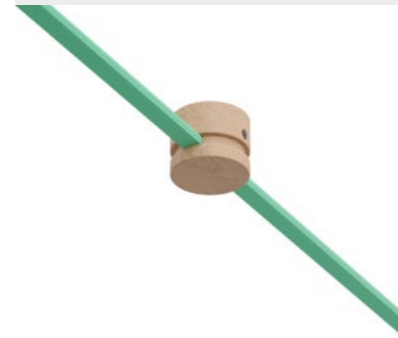

- PASLCAT02
- PASLCAT03
- PASLCAT01

H 40mm, Ø 50mm

Oval canopy with central hole

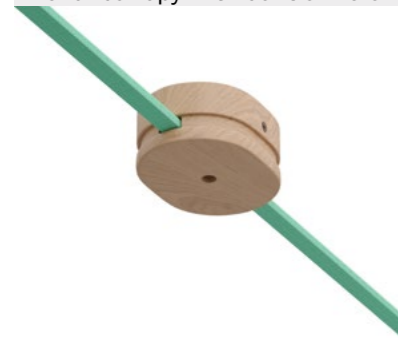

- RLCAT32
- RLCAT33
- RLCAT31

H 40mm, L 110mm, P 80mm

Terminal block



- TLCAT02
- TLCAT03
- TLCAT01

H 40mm, Ø 50mm

Fermaluce



adjustable
Tilted up to 90° & rotated by 315°

- RLCAT32SPOT
- RLCAT33SPOT

Lampholder for lampshades



- RLCAT33SPOT

E27

Flat cables

Specifications:

H05RNH2-F 300/500VAC Rectangular flat shaped 2x1,5mm² cable

Standard reference: EN 50525-2-82 and IEC 60245.

The cable is sold by the meter, multiple orders will be delivered in one piece up to a maximum of 25 meters in length.

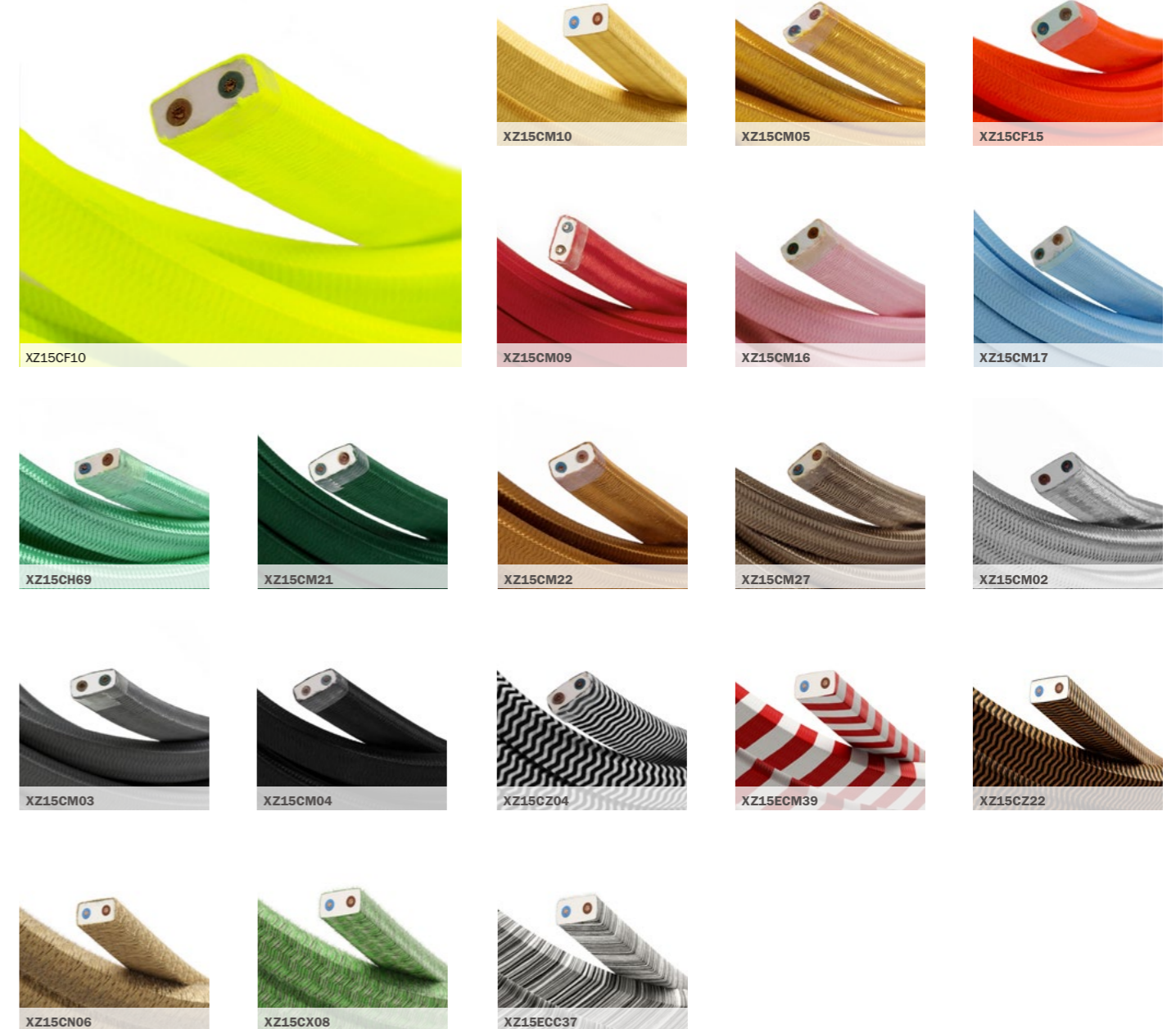

Filé System Kits

The Wiggle and the Linear kits have been designed to help you create simple yet unusual and catchy designs on your walls and ceilings without needing to make a custom project for them.

Wiggle kit

The Wiggle kit has been designed to help you re-create a simple yet unusual zigzag design on your walls. The kit is available in multiple versions: choose the color of the cable and of the components to best suit your design needs.

It is composed of 3m of cable, 1 round canopy, 2 lamp holders E27, 1 wall fairlead and 1 terminal block.



○	●	●	○	●	●		
	CAT02-WIG-CF10	CAT03-WIG-CF10	CAT-WIG-CF10		CAT02-WIG-CM27	CAT03-WIG-CM27	CAT-WIG-CM27
	CAT02-WIG-CM10	CAT03-WIG-CM10	CAT-WIG-CM10		CAT02-WIG-CM02	CAT03-WIG-CM02	CAT-WIG-CM02
	CAT02-WIG-CM05	CAT03-WIG-CM05	CAT-WIG-CM05		CAT02-WIG-CM03	CAT03-WIG-CM03	CAT-WIG-CM03
	CAT02-WIG-CF15	CAT03-WIG-CF15	CAT-WIG-CF15		CAT02-WIG-CM04	CAT03-WIG-CM04	CAT-WIG-CM04
	CAT02-WIG-CM09	CAT03-WIG-CM09	CAT-WIG-CM09		CAT02-WIG-CZ04	CAT03-WIG-CZ04	CAT-WIG-CZ04
	CAT02-WIG-CM16	CAT03-WIG-CM16	CAT-WIG-CM16		CAT02-WIG-ECM39	CAT03-WIG-ECM39	CAT-WIG-ECM39
	CAT02-WIG-CM17	CAT03-WIG-CM17	CAT-WIG-CM17		CAT02-WIG-CZ22	CAT03-WIG-CZ22	CAT-WIG-CZ22
	CAT02-WIG-CH69	CAT03-WIG-CH69	CAT-WIG-CH69		CAT02-WIG-CN06	CAT03-WIG-CN06	CAT-WIG-CN06
	CAT02-WIG-CM21	CAT03-WIG-CM21	CAT-WIG-CM21		CAT02-WIG-CX08	CAT03-WIG-CX08	CAT-WIG-CX08
	CAT02-WIG-CM22	CAT03-WIG-CM22	CAT-WIG-CM22		CAT02-WIG-ECC37	CAT03-WIG-ECC37	CAT-WIG-ECC37

Cable length: 3mt

Components included: 1 canopy, 2 lamp holders E27, 1 wall fairlead, 1 terminal block.

Linear kit

The Linear kit has been designed to help you re-create a simple design that is perfect for illuminating a hallway with lateral electrical connection. The kit is available in multiple versions: choose the color of the cable and of the components to best suit your design needs.

It is composed of 5m of cable, 1 round canopy, 3 lamp holders E27, 2 wall fairleads and 1 terminal block

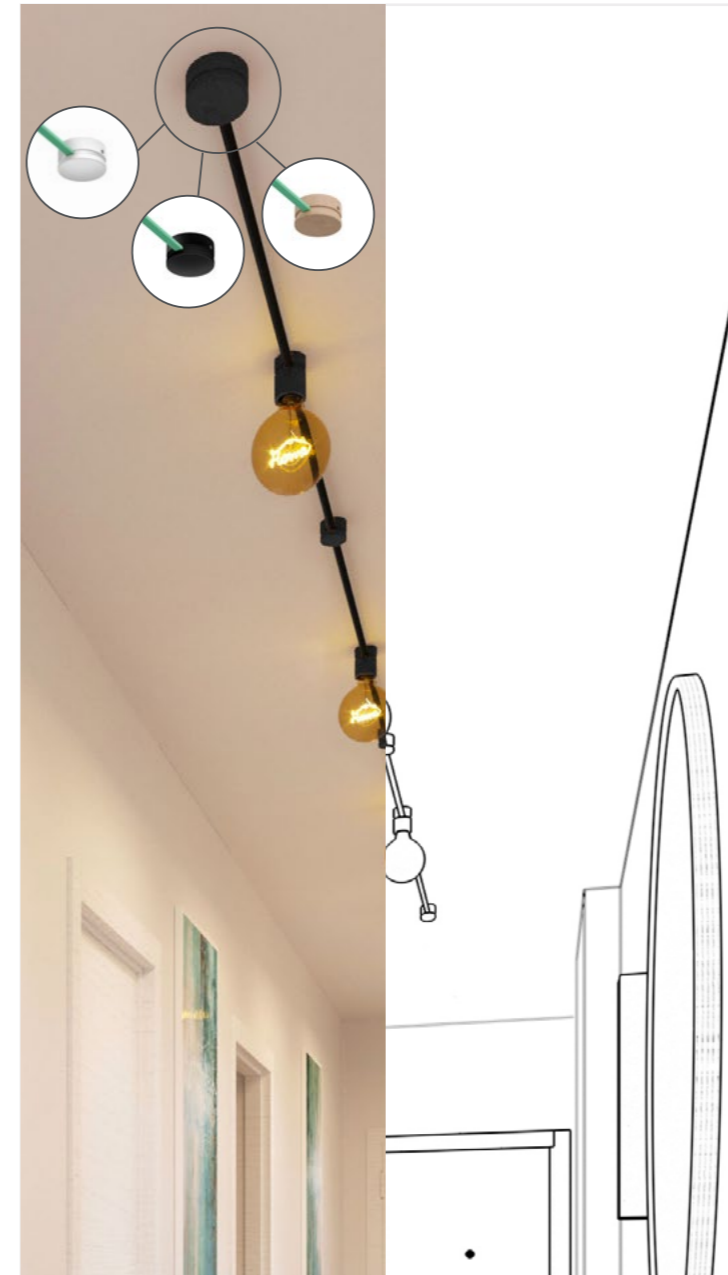

○	●	●	
	CAT02-LIN-CF10	CAT03-LIN-CF10	CAT-LIN-CF10
	CAT02-LIN-CM10	CAT03-LIN-CM10	CAT-LIN-CM10
	CAT02-LIN-CM05	CAT03-LIN-CM05	CAT-LIN-CM05
	CAT02-LIN-CF15	CAT03-LIN-CF15	CAT-LIN-CF15
	CAT02-LIN-CM09	CAT03-LIN-CM09	CAT-LIN-CM09
	CAT02-LIN-CM16	CAT03-LIN-CM16	CAT-LIN-CM16
	CAT02-LIN-CM17	CAT03-LIN-CM17	CAT-LIN-CM17
	CAT02-LIN-CH69	CAT03-LIN-CH69	CAT-LIN-CH69
	CAT02-LIN-CM21	CAT03-LIN-CM21	CAT-LIN-CM21
	CAT02-LIN-CM22	CAT03-LIN-CM22	CAT-LIN-CM22
	CAT02-LIN-CM27	CAT03-LIN-CM27	CAT-LIN-CM27
	CAT02-LIN-CM02	CAT03-LIN-CM02	CAT-LIN-CM02
	CAT02-LIN-CM03	CAT03-LIN-CM03	CAT-LIN-CM03
	CAT02-LIN-CM04	CAT03-LIN-CM04	CAT-LIN-CM04
	CAT02-LIN-CZ04	CAT03-LIN-CZ04	CAT-LIN-CZ04
	CAT02-LIN-ECM39	CAT03-LIN-ECM39	CAT-LIN-ECM39
	CAT02-LIN-CZ22	CAT03-LIN-CZ22	CAT-LIN-CZ22
	CAT02-LIN-CN06	CAT03-LIN-CN06	CAT-LIN-CN06
	CAT02-LIN-CX08	CAT03-LIN-CX08	CAT-LIN-CX08
	CAT02-LIN-ECC37	CAT03-LIN-ECC37	CAT-LIN-ECC37

Cable length: 5mt

Components included: 1 canopy, 3 lamp holders E27, 2 wall fairlead, 1 terminal block.

Symmetric kit

The Symmetric kit has been designed to help you re-create a simple design that is perfect to illuminate a hallway with central electrical connection. The kit is available in multiple versions: choose the color of the cable and of the components to best suit your design needs.

It is composed of 5m of cable, 1 oval canopy, 4 lamp holders E27, 2 wall fairleads and 2 terminal block.

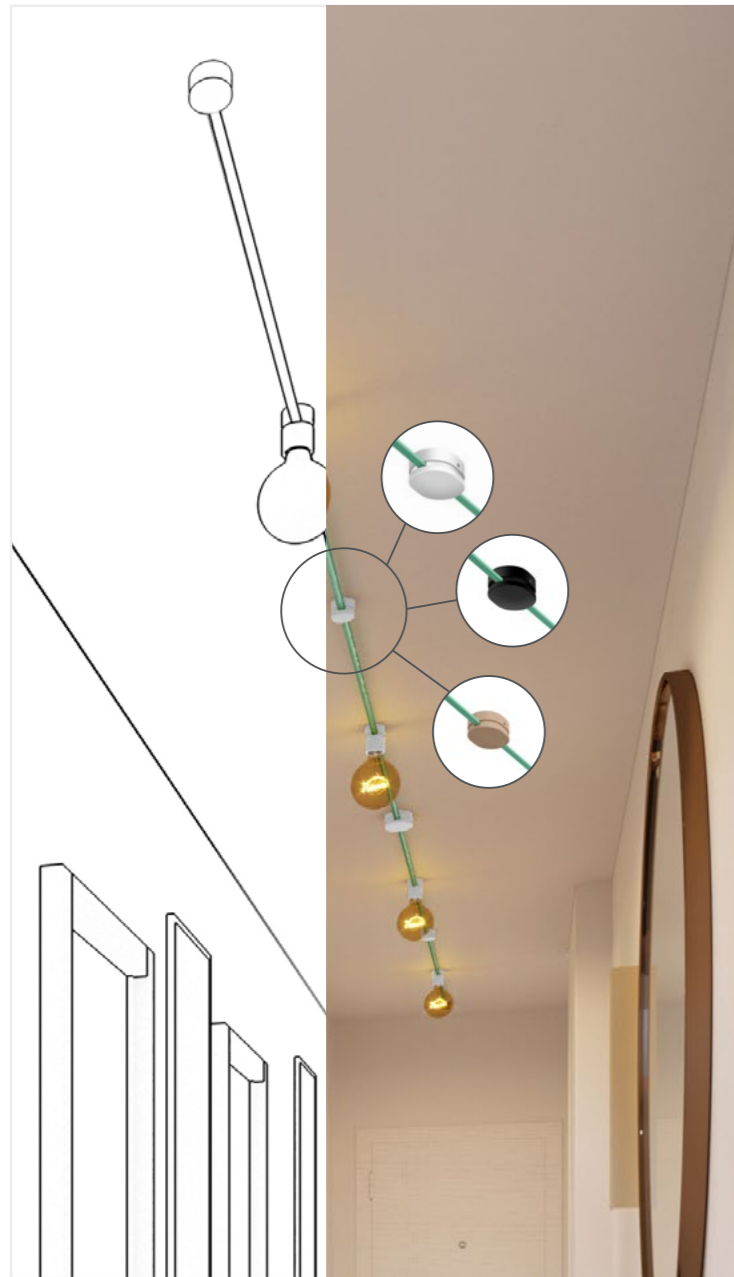

	○	●	●
	CAT02-LIN2-CF10	CAT03-LIN2-CF10	CAT-LIN2-CF10
	CAT02-LIN2-CM10	CAT03-LIN2-CM10	CAT-LIN2-CM10
	CAT02-LIN2-CM05	CAT03-LIN2-CM05	CAT-LIN2-CM05
	CAT02-LIN2-CF15	CAT03-LIN2-CF15	CAT-LIN2-CF15
	CAT02-LIN2-CM09	CAT03-LIN2-CM09	CAT-LIN2-CM09
	CAT02-LIN2-CM16	CAT03-LIN2-CM16	CAT-LIN2-CM16
	CAT02-LIN2-CM17	CAT03-LIN2-CM17	CAT-LIN2-CM17
	CAT02-LIN2-CH69	CAT03-LIN2-CH69	CAT-LIN2-CH69
	CAT02-LIN2-CM21	CAT03-LIN2-CM21	CAT-LIN2-CM21
	CAT02-LIN2-CM22	CAT03-LIN2-CM22	CAT-LIN2-CM22
	CAT02-LIN2-CM27	CAT03-LIN2-CM27	CAT-LIN2-CM27
	CAT02-LIN2-CM02	CAT03-LIN2-CM02	CAT-LIN2-CM02
	CAT02-LIN2-CM03	CAT03-LIN2-CM03	CAT-LIN2-CM03
	CAT02-LIN2-CM04	CAT03-LIN2-CM04	CAT-LIN2-CM04
	CAT02-LIN2-CZ04	CAT03-LIN2-CZ04	CAT-LIN2-CZ04
	CAT02-LIN2-ECM39	CAT03-LIN2-ECM39	CAT-LIN2-ECM39
	CAT02-LIN2-CZ22	CAT03-LIN2-CZ22	CAT-LIN2-CZ22
	CAT02-LIN2-CN06	CAT03-LIN2-CN06	CAT-LIN2-CN06
	CAT02-LIN2-CX08	CAT03-LIN2-CX08	CAT-LIN2-CX08
	CAT02-LIN2-ECC37	CAT03-LIN2-ECC37	CAT-LIN2-ECC37

Cable length: 5mt

Components included: 1 oval canopy, 4 lamp holders E27, 2 wall fairlead, 2 terminal blocks.

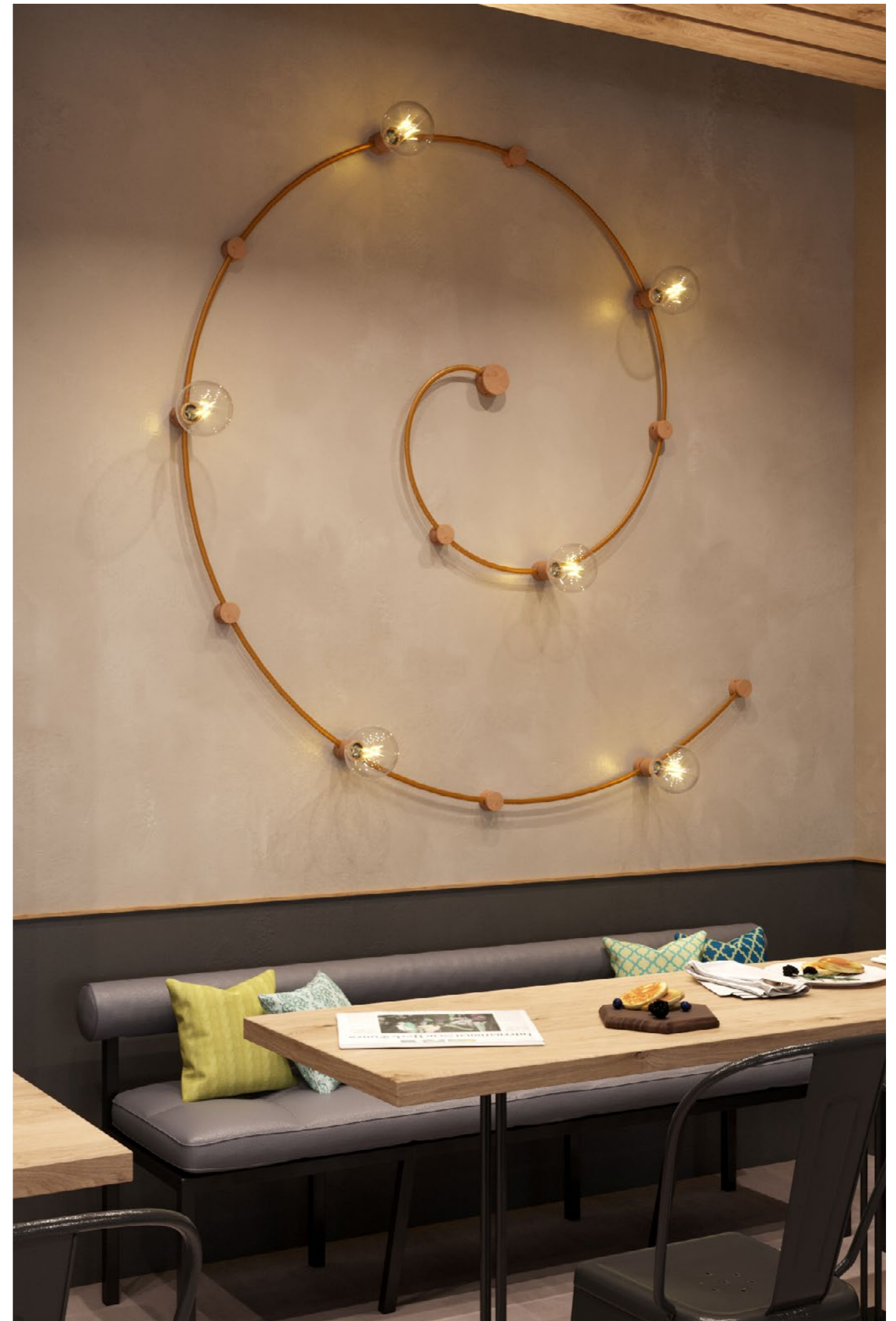



S14 SYSTEM

INDOOR

*Create unique lighting solutions
with S14 SYSTEM.*

S14 is the Creative-Cables
system that allows anyone
to create spectacular lighting
solutions using a piece of
lighting history: tube bulbs.

S14 SYSTEM

Systems for linear S14d LED bulbs

S14 linear LED lamps are perfect for wall installation, for creating wall combinations or as bathroom and outdoor lamps. Thanks to Creative-Cables' exclusive solutions, they can also be used as pendant lamps, increasing their possibilities of use and creating original and creative compositions. Available lampholders are **esse14** and **Syntax®**.

1

Bathroom lighting



Multiple compositions

2



3

Outdoor spaces

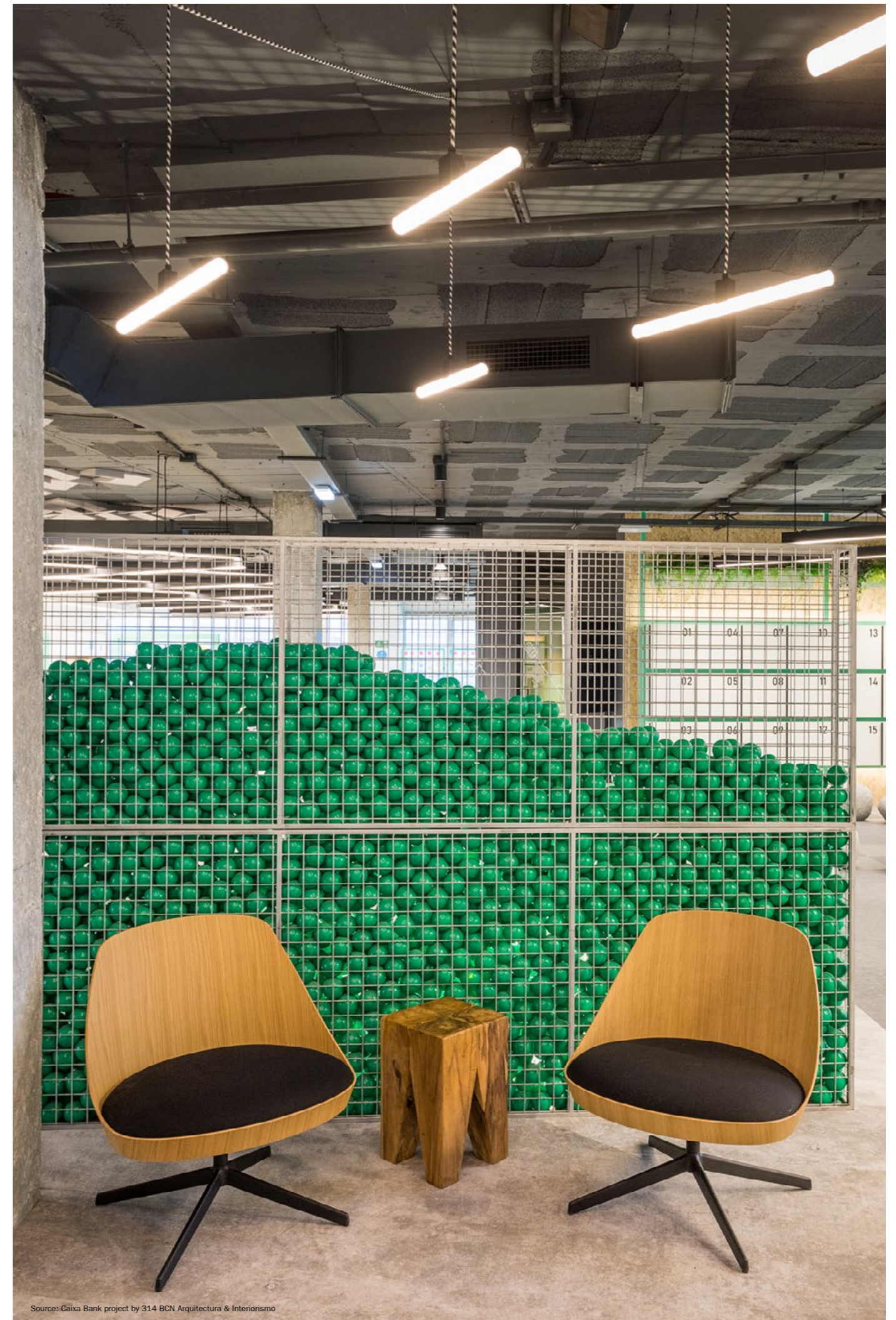

Source: Caixa Bank project by 314 BCN Arquitectura & Interiorismo

ESSE14: wall or ceiling lampholders

Curved, small and design-oriented, you can give shape to your creations without worrying about their taking up too much space. It does not require a ceiling rose and can be attached directly to the wall. An exclusive Creative-Cables creation, designed to resist humidity thanks to its IP44 certification when combined with 30 or 50 cm linear LED bulbs.

esse • 14



- KPLS14DPN
- KPLS14DPB
- PLS14DPBM
- PLS14DPWM

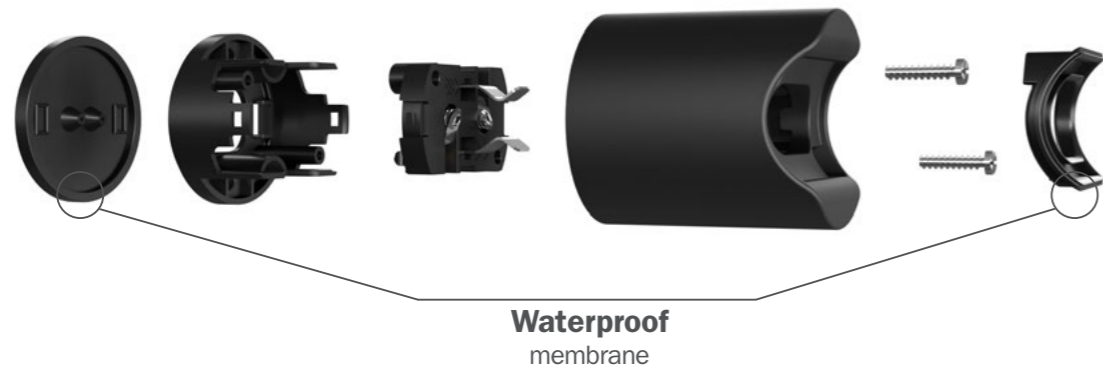

Waterproof
membrane



SYNTAX: lampholders for pendant lighting

The linear lamps with S14d socket are not restricted to basic wall or ceiling installation, but can also be presented in all their glory in suspension, or with a swivel joint, and may be combined in different compositions with never-before-seen scenographic effects, owing to the Syntax system.



SYNTAX_S14D



SS14DTERP1NE

Syntax S14d cover and lamp holder kit

The kit includes a Syntax lamp holder with S14d fitting and a cover, an accessory that allows you to cover your lamp holder whilst hiding the cable clamp. This metal lamp holder cover works as a sheathing for the S14d lamp holder and is available in different finishes - choose the one that suits your style. The Gold finish is a perfect match to the golden LED linear bulbs, whereas the Silver finish suits the Smoky Grey linear bulbs, and yet again the white version is excellent combined with the opaline linear bulbs for a total white effect.

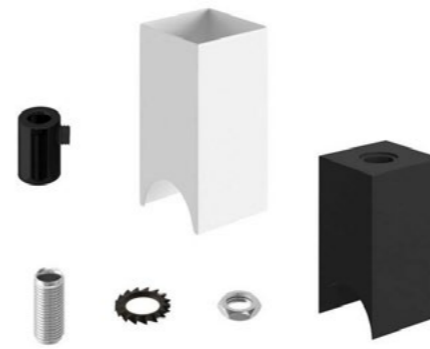

KBXS14DVBO



KBXS14DOTS



KBXS14DTIS



KBXS14DRAS

Bulbs

The S14d lamp holders can be matched with a wide range of linear bulbs. Transparent, gold, smoky grey and opal finishes are available in 3 different lengths: small, medium and large. All the bulbs are dimmable.

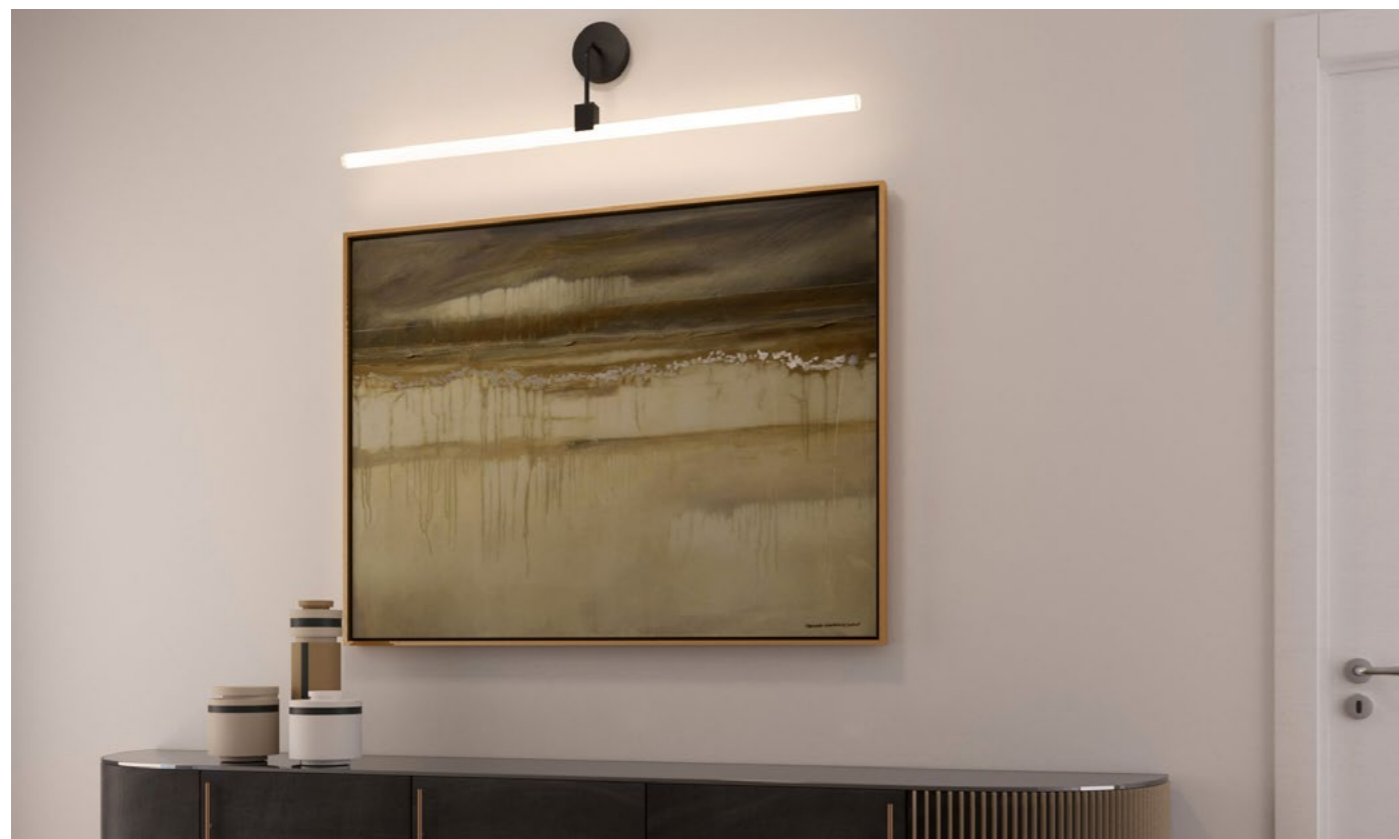
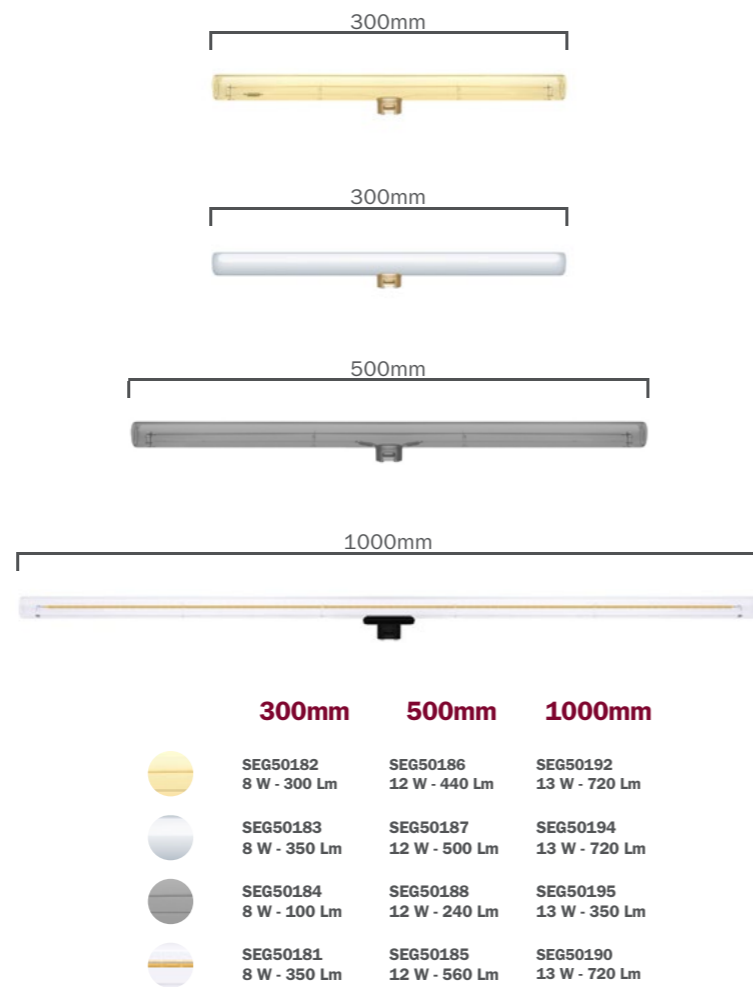

S14 lamps

The elegance and design of these lamps create a sophisticated atmosphere. The pendant version is ideal for minimal yet functional lighting along corridors or in large open spaces. Alternatively, wall lamps provide functional and decorative illumination, such as above a mirror or picture. S14 Lamps can be purchased with or without a bulb.





CREATIVE-TUBES SYSTEM INDOOR

*Create your own personalized,
visible wiring installation with TUBES.*

Tubes are the Creative-Cables system that combines the beauty of the fabric covering with the practicality of a true surface wall system.

The Tubes system eliminates the need for ugly plastic electrical conduits or rigid metal pipework.

CREATIVE-TUBES SYSTEM

1

Flexible

Creative-Tube combines the fabric-covered sheath with two metal filaments, allowing the conduit to maintain its shape when bent. It adapts to suit your needs.

2

Tailor-made

Create a beautiful and functional bespoke visible system that takes into account your daily needs and the style of your rooms

3

Creative and safe

You have the freedom to exhibit your electrical system. Create a wall design that is a functional light source without sacrificing safety; the system adheres to the highest standards.

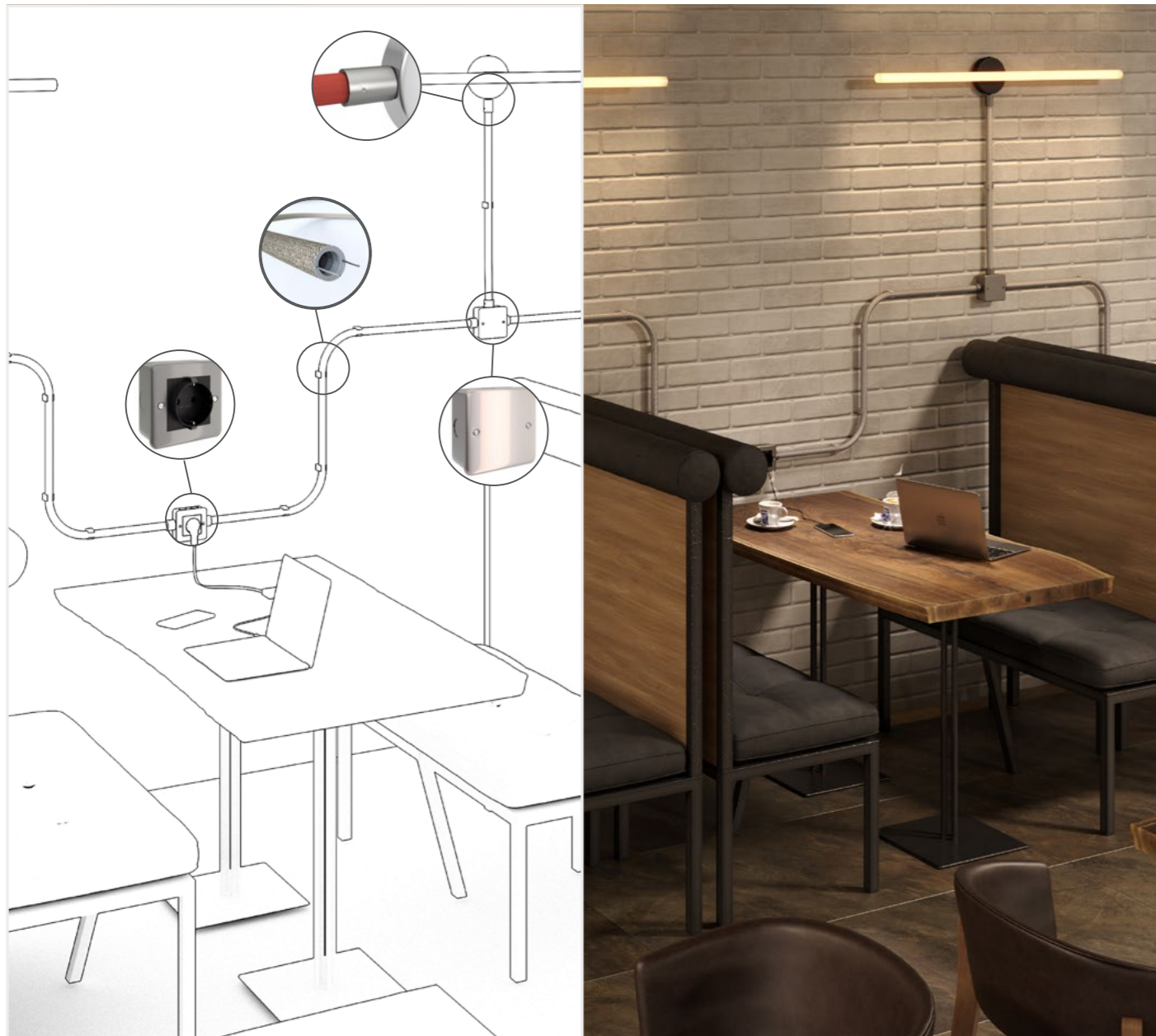

Creative-Tube 20mm

Specifications:

Their internal material complies with CEI-EN 61386-1 + EN 61386-22 Classification 3321.

Classification No: 3321

Crushing Resistance: >750N on 5cm at 20°C

Shock Resistance: (-15°C) after applying 2 kg mass hammer

Operating Temperature: -5°C to +60°C

Resistance to flame propagation: self-extinguishing VO

Dielectric strength: <2000V A 50Hz

Insulation resistance: >100 mega ohm

Diameter: 20mm

The tube is sold by the meter, multiple orders will be delivered in one piece up to a maximum of 30 meters in length.



Junction boxes

Create many designs and find the answer to your functional needs with our range of Junction Boxes for Creative Tubes. Plugs and switches in different standards, both available on single and double boxes.



Creative-Tube accessories

Discover all the amazing possibilities offered by Creative-Tubes and take the time to discover the accessories that best serve your creativity.

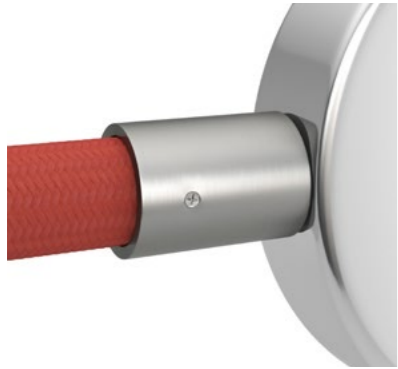

TERM6ZI

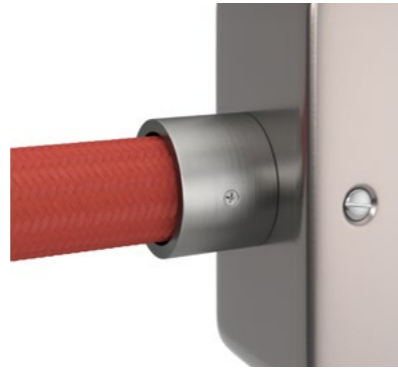

TERM3ZI



CLIPD20



CTCLIPBI



CTCLIPNE



CTCLIPNE





ROSE-ONE SYSTEM

INDOOR

The first versatile and easily customizable ceiling rose. Create unique multi-pendant lamps with ROSE-ONE ceiling roses.

Rose-One System is a Creative-Cables exclusive solution allowing everyone to create wonderful multi-pendant lamps personalized on each one's needs.

PATENTED SOLUTION

ROSE-ONE SYSTEM

1

Invest with limited stock

Keep your stock limited without reducing the number of products you can sell. You can easily create your product combining the Rose-One bases with covers either already drilled or to be drilled.

Flexible and customizable solution

With Rose-One you will have the possibility to customize the product independently, defining the number and position of the pendant holes selected by your customer.

2

3

Wide choice of shapes, colors and finishes

You can choose from many combinations, which differ in shape, size, color or finish. If the available options are not enough you can request a custom finish!

Patented solution

Rose-One System is a revolutionary ceiling rose system allowing anyone creating and customizing single or multiple pendant lamps to personalize their space.

4

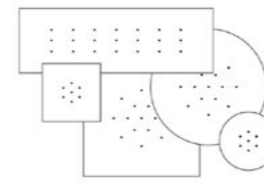

Shapes
Round, square or rectangular?
 With the Rose-One system, you can choose from a variety of shapes and sizes to find the rose that's right for you.



Colors and finishes
Matte, textured or metallic?
 Your Rose-One can be understated and elegant or informal and playful; take a look at our colorful decorations!

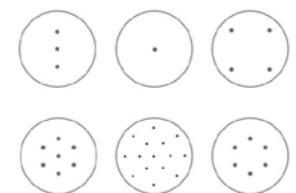

Number of pendants
 Our catalogue has a range of Rose-One options from 1 up to 15 holes to choose from, to make an installation with many pendants! In addition, custom roses can be made with the number and geometry of holes that your customer prefers.

4 side hole base

The Rose-One by Creative Cables is a Made in Italy patented solution that is characterized by a base with four entry/exit holes. How can you use them?

- Create up to 4 side drops in addition to those present in the cover of the Rose-One
- Connect multiple Rose-Ones together to illuminate areas of the room away from possible points of power sources.
- If there is no ceiling light you can use the side holes to connect the Rose-One to a nearby electrical outlet.

If the 4 holes of the base are not used, they can be closed with the caps provided in the package.

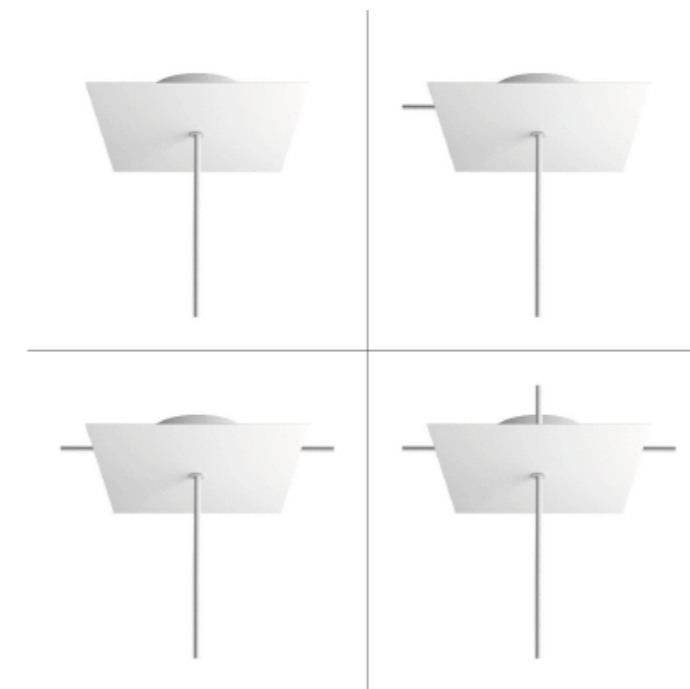
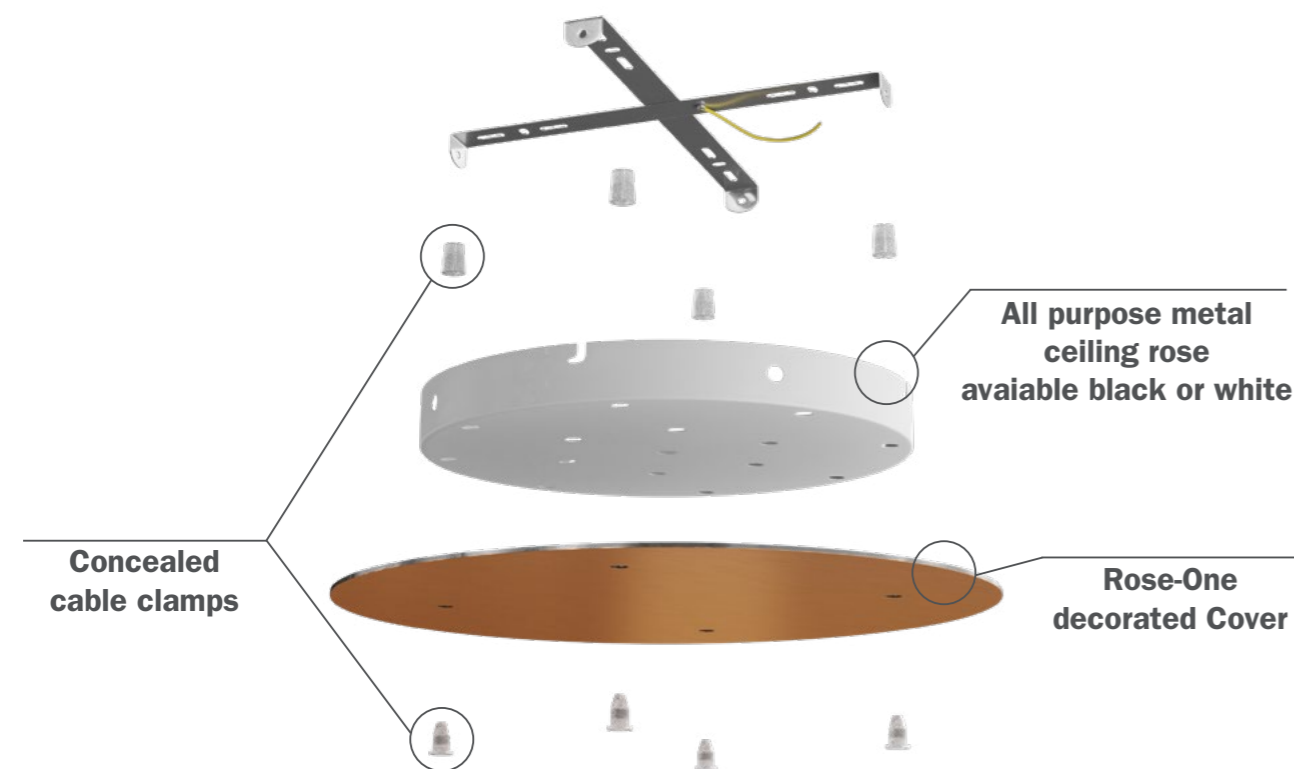

Multiple arrangements

The Rose-One rectangular or square, thanks to the many finishes available allows you to create multiple impressive suspensions in relation with the style of the rooms you are furnishing. The side holes allow you to easily connect several Rose-One to each other, starting from a single ceiling light point. They can be easily combined with each other to allow you to create different arrangements and geometric designs adaptable to your needs: lighting a living room, a table or a long bar counter.

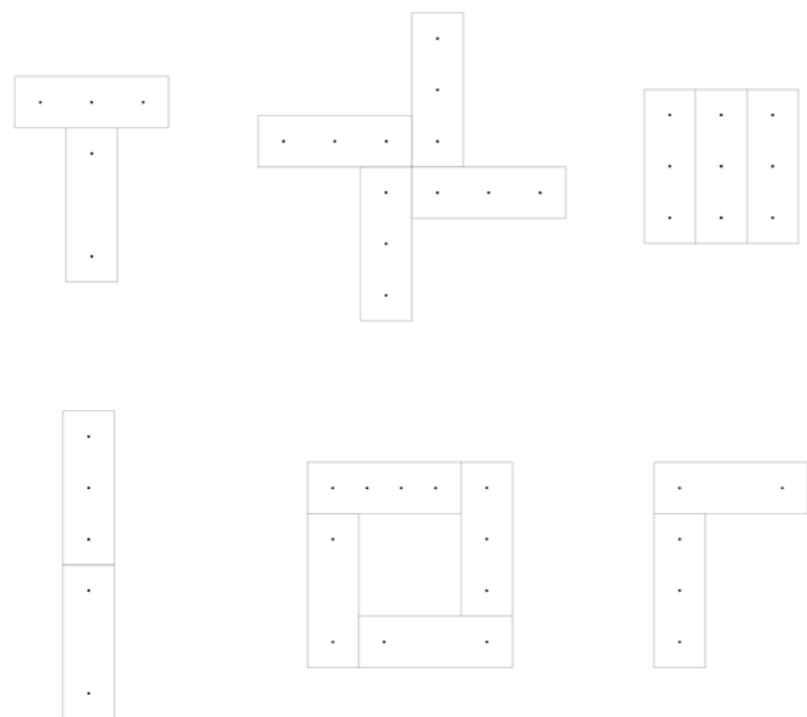

Rose-One: the customizable ceiling rose

With our template you can drill any round or square Rose-One cover in your shop with a common drill. The holes are numbered to make drilling easier: if you want, you can use our legend to reproduce the most classic drilling patterns (included in every pack). Unlike a classic range of rosettes, it will not be necessary to stock an infinite number of models, different in the number of holes and finishes: depending on customers requirements, you can create the desired product by combining the universal base to the dibond, already drilled or to be drilled with the appropriate template jig.

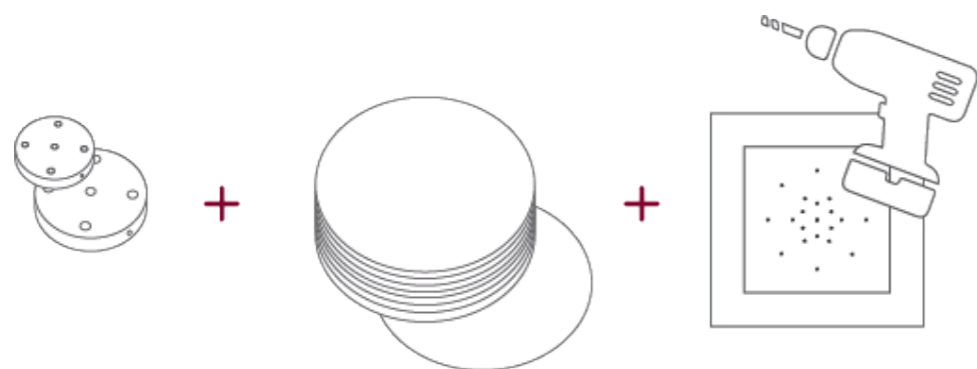

Rose-One Kits

For all our customers who like to create and design, being able to choose your ceiling rose for single or multi pendant lights just got a whole lot easier. Rose-One system comes in a wide variety of colors and design options. Look out for more options to come.

Round small 200mm

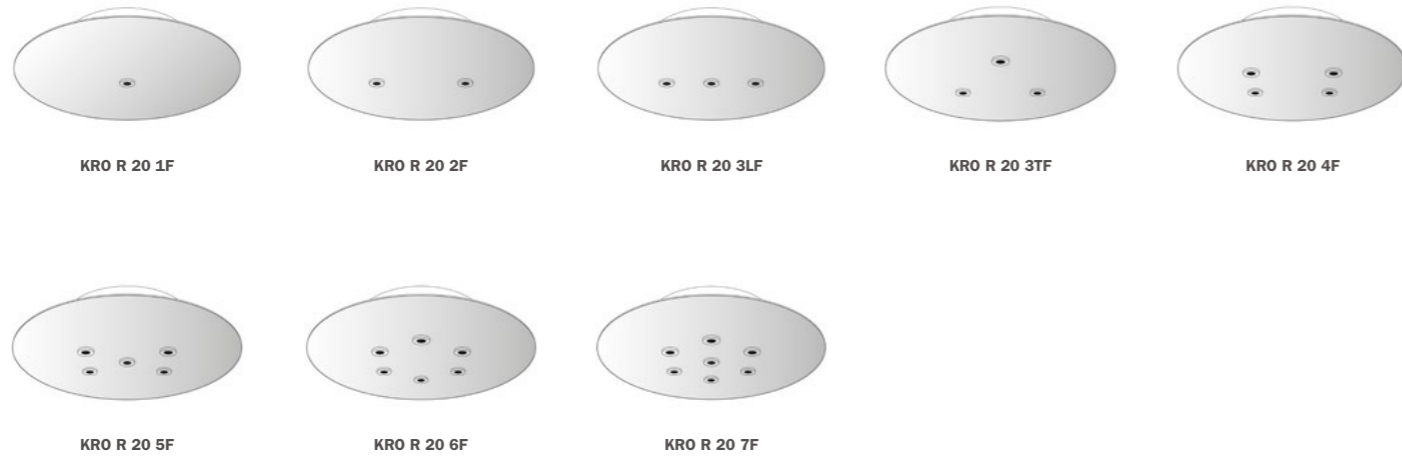

Round large 400mm

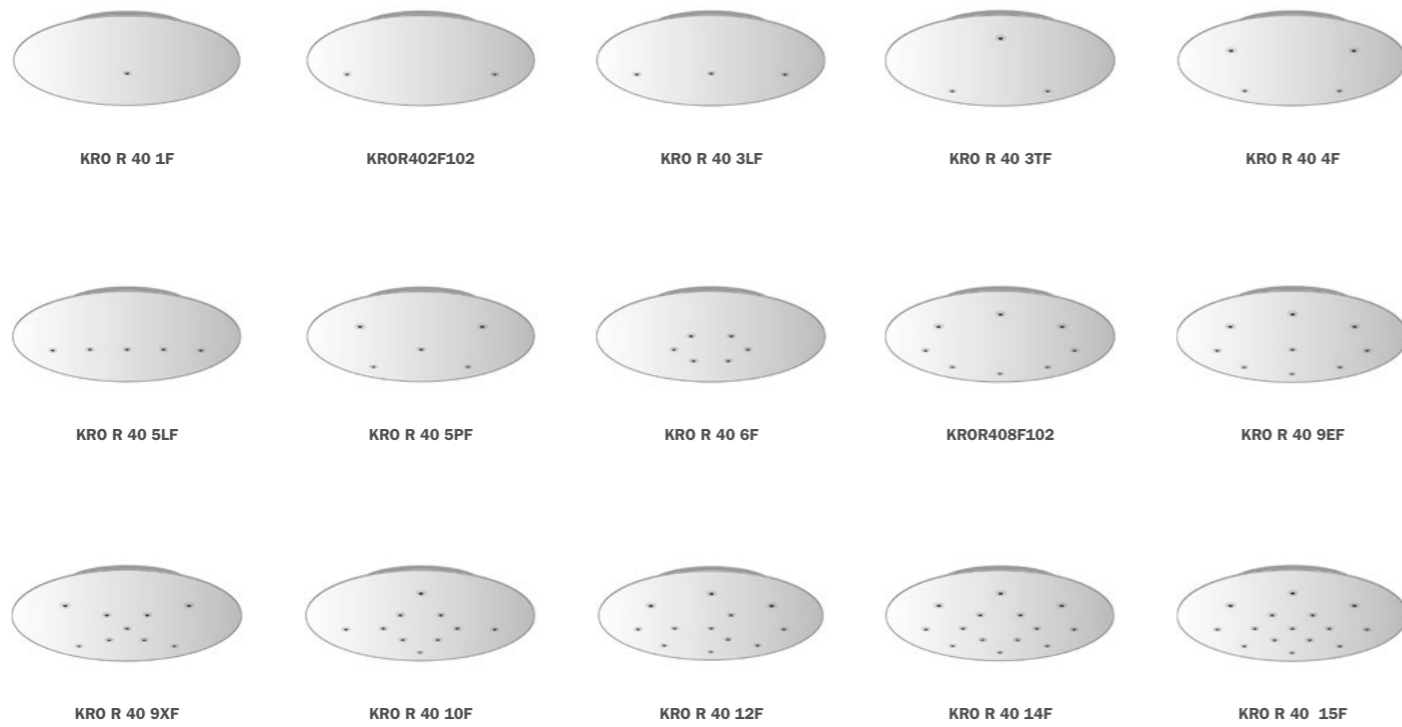

HOW TO COMPOSE THE PRODUCT CODE

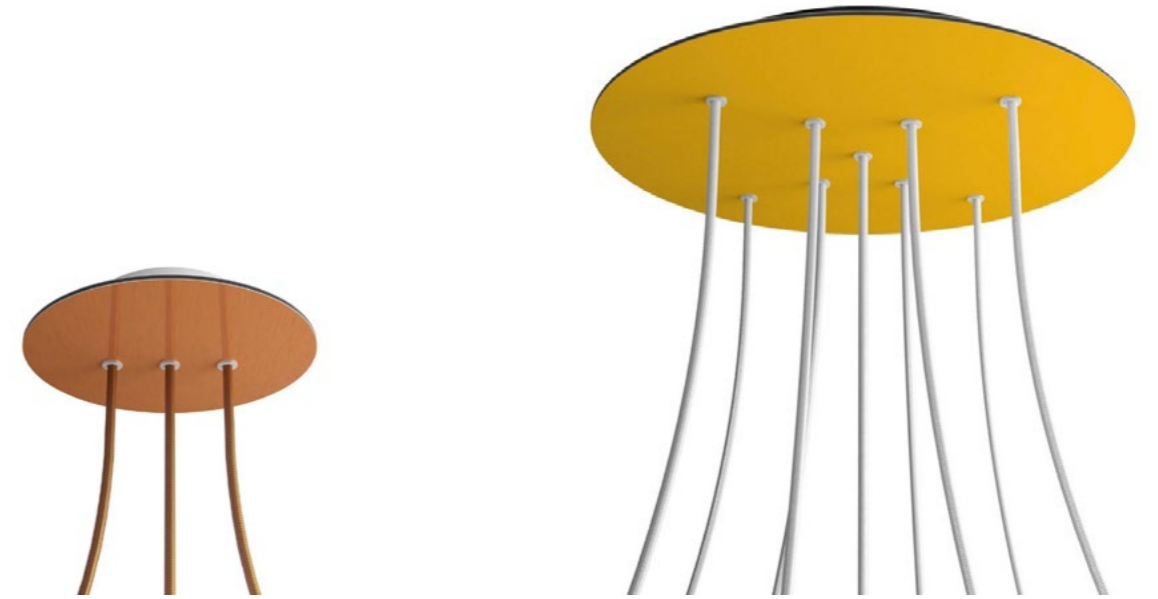

KRO R 20 3LF 108

Rose-One kit Round Ø Holes Decoration

KRO VN R 40 9XF 113

Rose-One kit Ceiling Rose Colour Round Ø Holes Decoration

102 Matte White	103 Matte Black	104 Marble Marquina	105 Marble Carrara	106 Concrete	107 Satin Brass Dibound
108 Satin Copper Dibound	109 Satin Steel Dibound	110 Wood	111 Anthracite	112 Mirror	113 Mustard
114 Soft Blue	115 Petrol	116 Soft Green			
			VN		

Square small 200mm

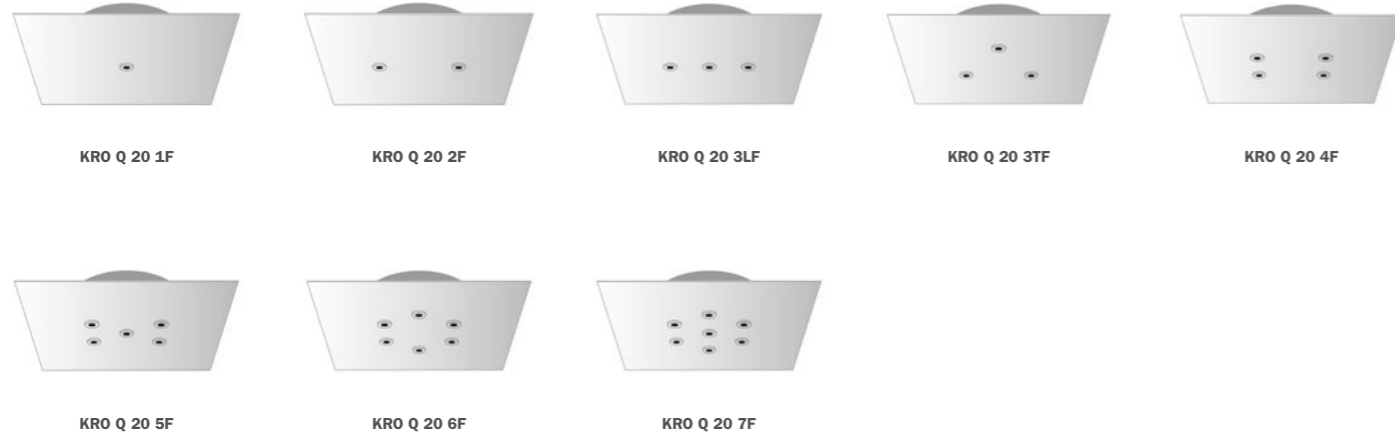

Square large 400mm

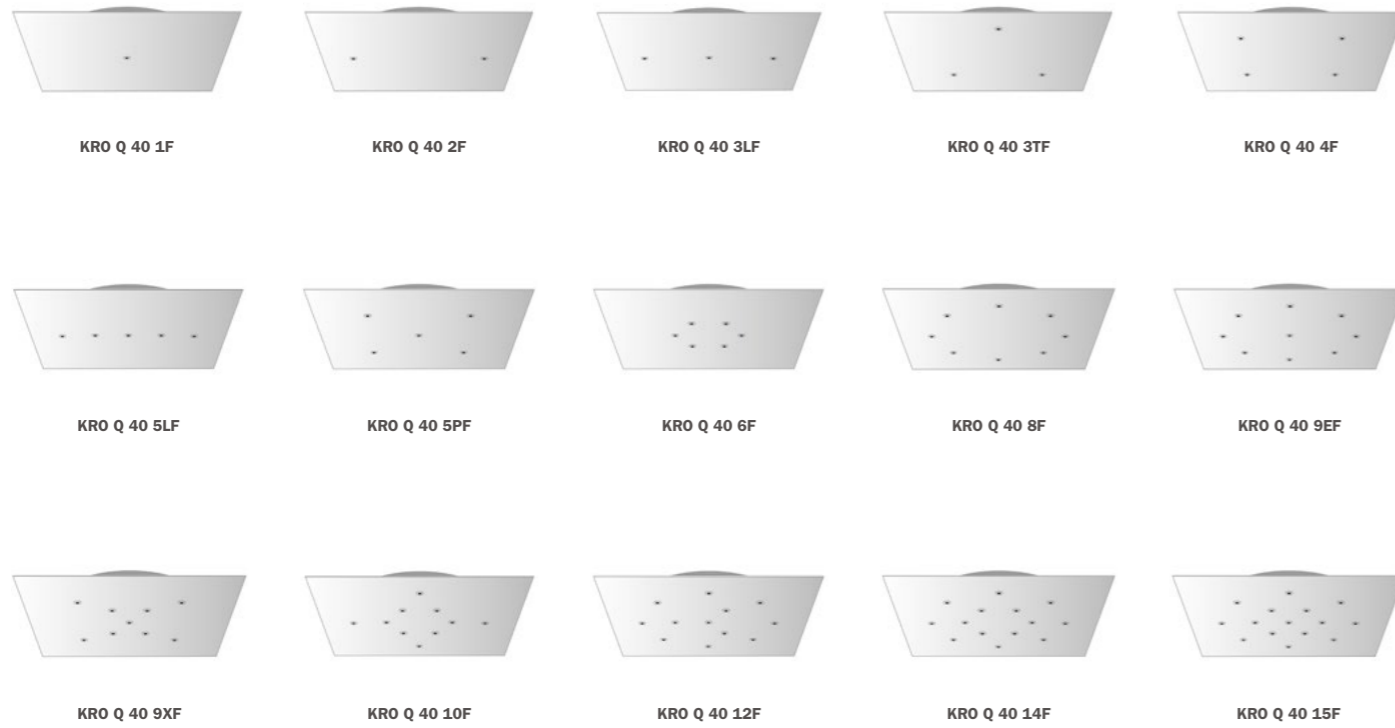

HOW TO COMPOSE THE PRODUCT CODE



KRO VN Q 20 6F 110

Rose-One kit Ceiling Rose Colour Round Ø Holes Decoration



102
Matte White



103
Matte Black

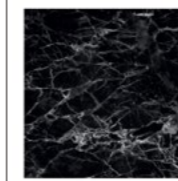

104
Marble Marquina

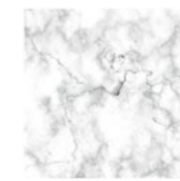

105
Marble Carrara



106
Concrete



107
Satin Brass Dibound



108
Satin Copper Dibound



109
Satin Steel Dibound



110
Wood



111
Anthracite



112
Mirror



113
Mustard



114
Soft Blue



115
Petrol



116
Soft Green

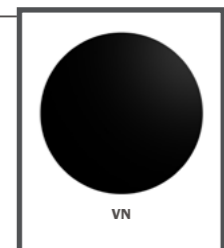

VN

Rectangular XXL 675 x 225mm

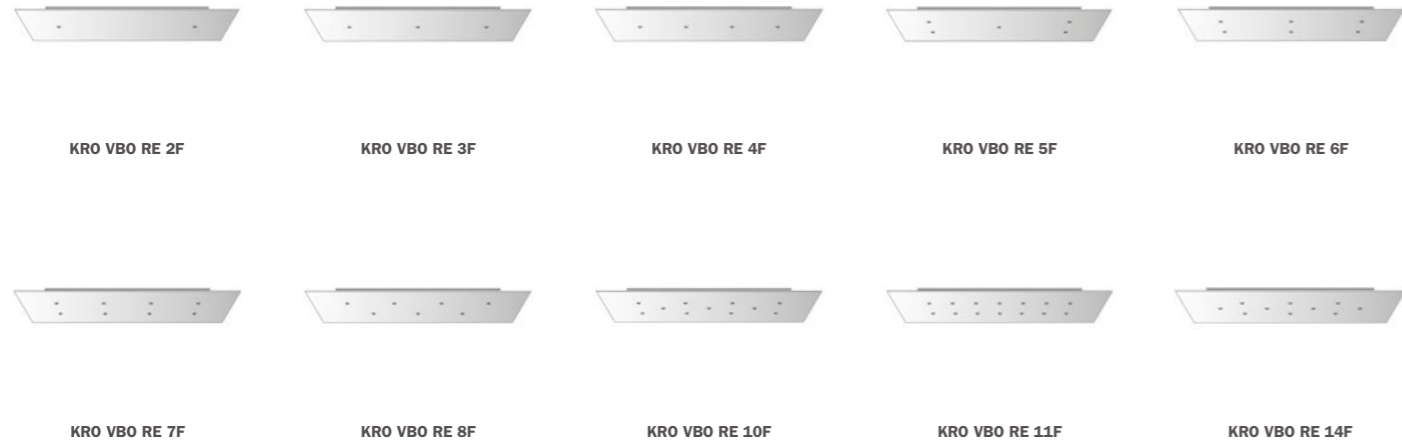

HOW TO COMPOSE THE PRODUCT CODE

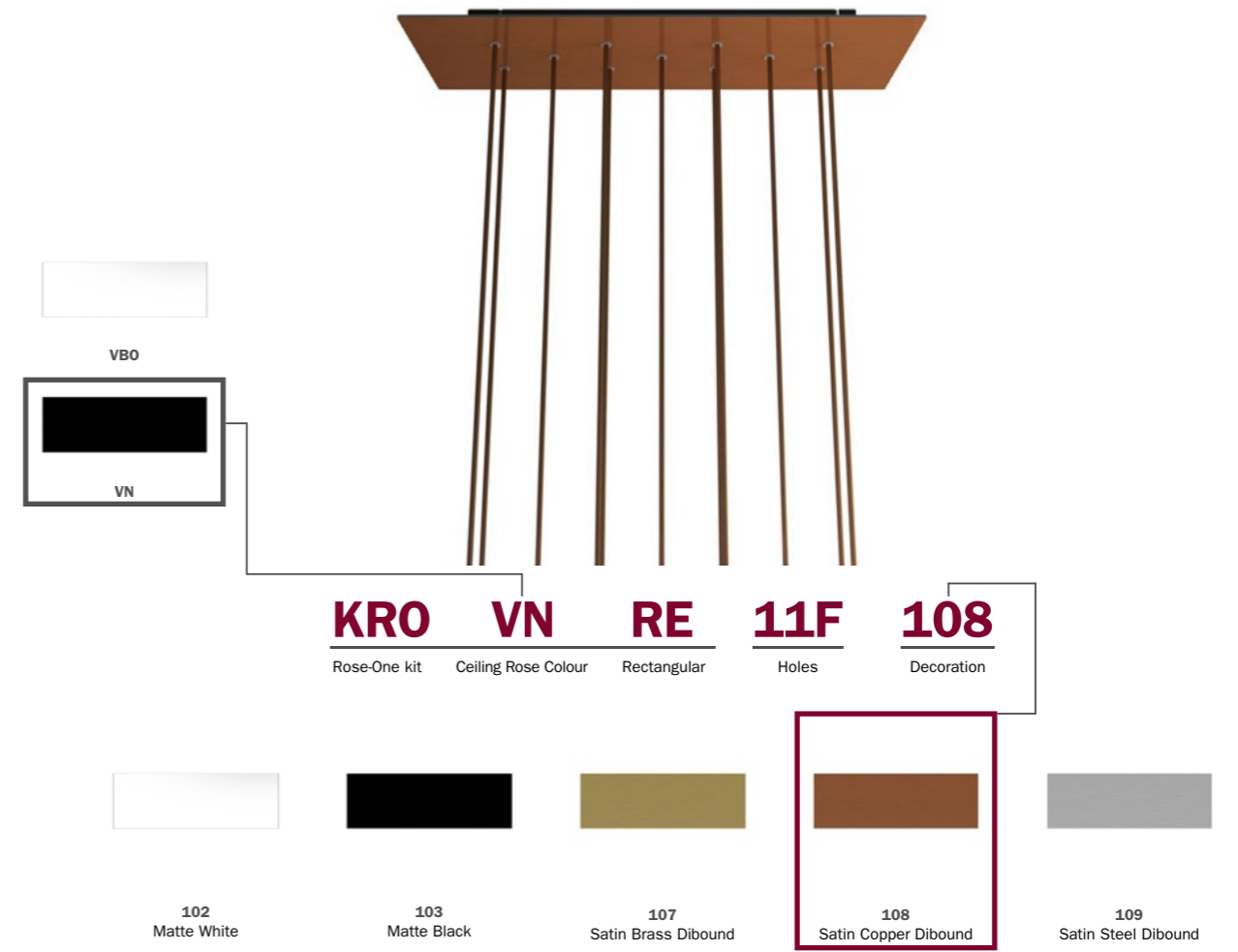



WHAT YOU NEED TO COMPOSE YOUR ROSE-ONE CEILING ROSE

You'll be able to build your Rose-One ceiling rose in 3 simple steps. One - choose pre-drilled or undrilled cover's shape, size and Decorazione. Two - choose one of the 3 metal ceiling roses: Rotondo small for smaller covers, Rotondo big for the bigger ones and rectangular for rectangular covers. All available in white or black. Three - complete your ceiling rose with transparent hidden cable clamps. Easy not? And you can also optimize your warehouse's stock! How? Depending on your customers' requirements, you can easily create your product combining the Rose-One bases with covers either already drilled or to be drilled. A lot of choices for your Clients with a minimum stock, what do you need more?

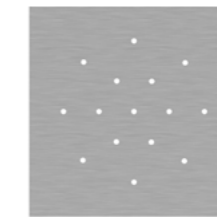

PRE-DRILLED



UNDRILLED



Cover

Choose the shape, the size and the decoration. You can either buy it:



Base metal ceiling rose

Depending on the cover you chose, you will need to choose the correct one from the 3 available metal ceiling roses: round small for smaller covers, round big for bigger covers or rectangular (either white or black) for rectangular covers.



Cable clamps

Add the transparent hidden cable clamps to your cart in order to complete your ceiling rose.

Warning!

If you buy undrilled covers you will also need to buy a template in order to ensure that you drill the holes correctly.

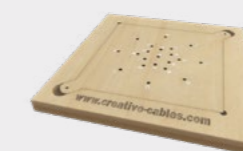
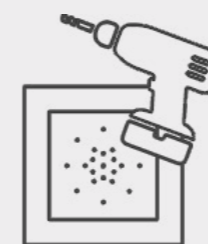

1. Pre-drilled covers

The Rose-One pre-drilled come in three different shapes: square, round and rectangular. And the squared and round versions are available in two different diameters, 200 and 400mm. Covers are pre-drilled with 1 to 15 holes depending on their dimension following different kind of punching schemes. Covers come in different designs and colors and are made in aluminum or dibond. Complete the Rose-One ceiling rose with specific accessories: a metal ceiling rose and cable clamps.

Round small 200mm



CVF R 20 1F



CVF R 20 2F



CVF R 20 3LF



CVF R 20 3TF



CVF R 20 4F



CVF R 20 5F



CVF R 20 6F



CVF R 20 7F

Round large 400mm

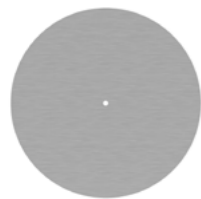

CVF R 40 1F

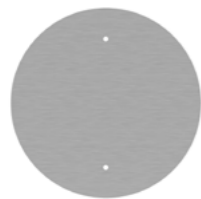

CVF R 40 2F

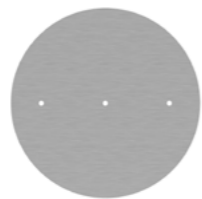

CVF R 40 3LF

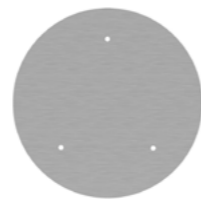

CVF R 40 3TF

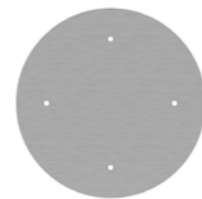

CVF R 40 4F

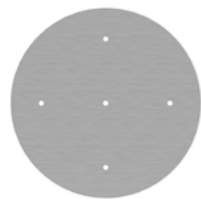

CVF R 40 5PF

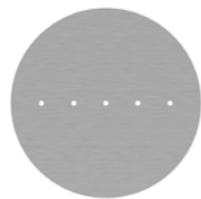

CVF R 40 5LF

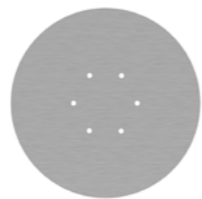

CVF R 40 6F

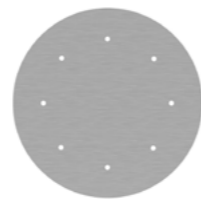

CVF R 40 8F

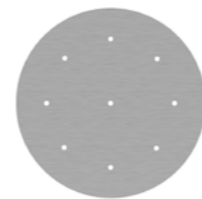

CVF R 40 9EF

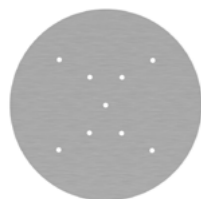

CVF R 40 9XF

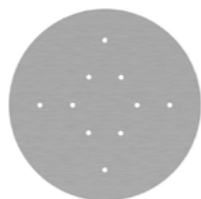

CVF R 40 10F

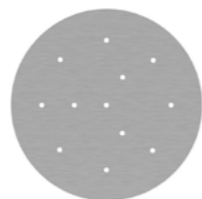

CVF R 40 12F

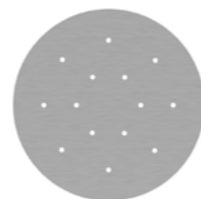

CVF R 40 14F

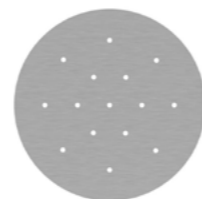

CVF R 40 15F

HOW TO COMPOSE THE PRODUCT CODE

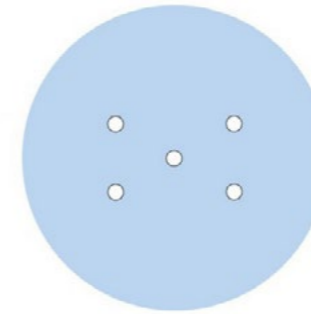

CVF R 20 5F 114

Pre-drilled covers Round Ø Holes Decoration

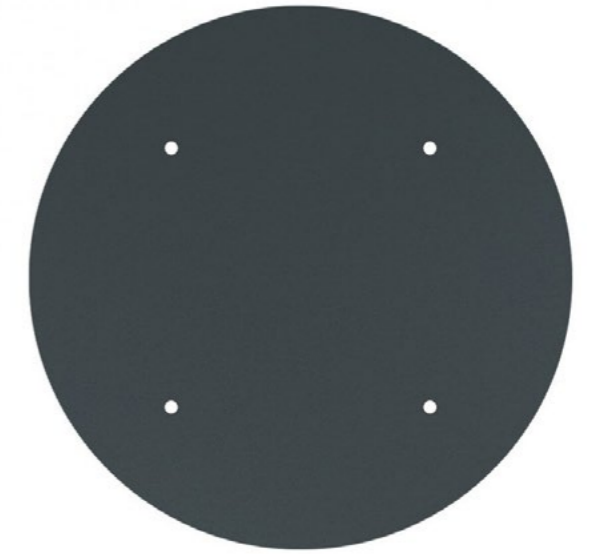

CVF R 40 4F 111

Pre-drilled covers Round Ø Holes Decoration

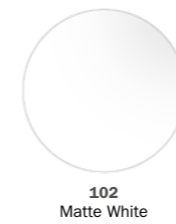

102
Matte White



103
Matte Black

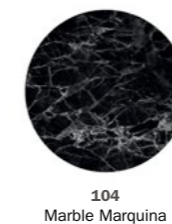

104
Marble Marquina



105
Marble Carrara

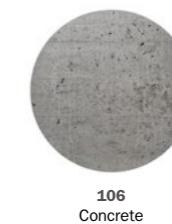

106
Concrete



107
Satin Brass Dibond



108
Satin Copper Dibond

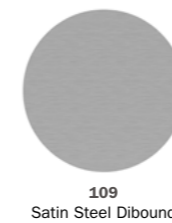

109
Satin Steel Dibond

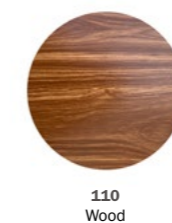

110
Wood



111
Anthracite



112
Mirror

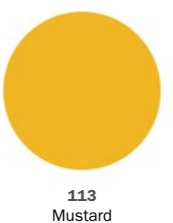

113
Mustard

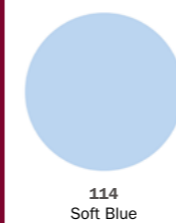

114
Soft Blue

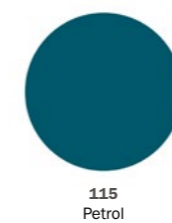

115
Petrol

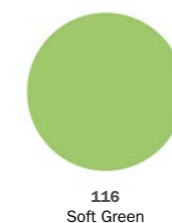

116
Soft Green

Square small 200mm

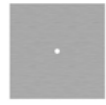

CVF Q 20 1F



CVF Q 20 2F



CVF Q 20 3LF



CVF Q 20 3TF



CVF Q 20 4F



CVF Q 20 5F

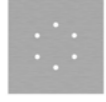

CVF Q 20 6F



CVF Q 20 7F

Square large 400mm

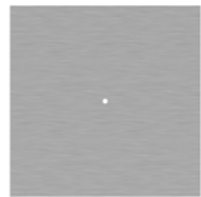

CVF Q 40 1F

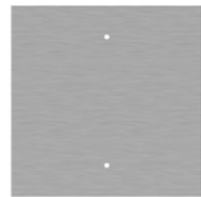

CVF Q 40 2F

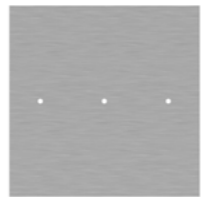

CVF Q 40 3LF

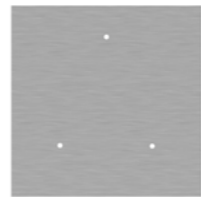

CVF Q 40 3TF

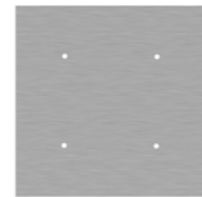

CVF Q 40 4F

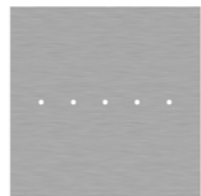

CVF Q 40 5LF

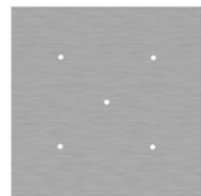

CVF Q 40 5PF

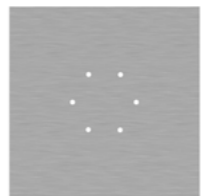

CVF Q 40 6F

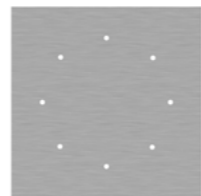

CVF Q 40 8F

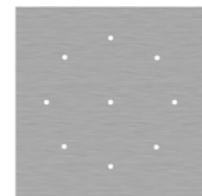

CVF Q 40 9EF

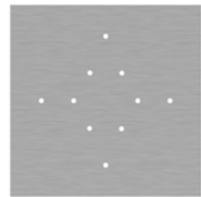

CVF Q 40 10F

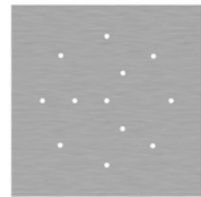

CVF Q 40 12F

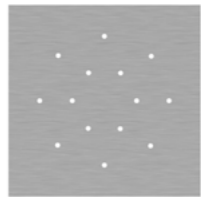

CVF Q 40 14F

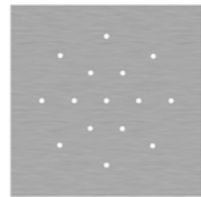

CVF Q 40 15F

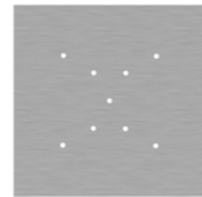

CVF Q 40 9XF

HOW TO COMPOSE THE PRODUCT CODE

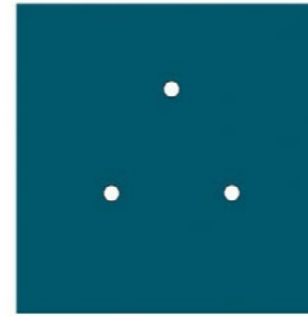

CVF Q 20 3TF 115

Pre-drilled covers Square Ø Holes Decoration



102
Matte White



103
Matte Black

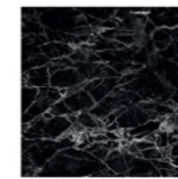

104
Marble Marquina

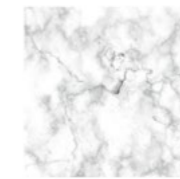

105
Marble Carrara



106
Concrete



107
Satin Brass Dibound



108
Satin Copper Dibound



109
Satin Steel Dibound



110
Wood



111
Anthracite



112
Mirror



113
Mustard



114
Soft Blue



115
Petrol



116
Soft Green

CVF Q 40 12F 112

Pre-drilled covers Square Ø Holes Decoration



105
Marble Carrara



106
Concrete



107
Satin Brass Dibound



111
Anthracite



112
Mirror



113
Mustard



116
Soft Green



114
Soft Blue

Rectangular XXL 675 x 225mm

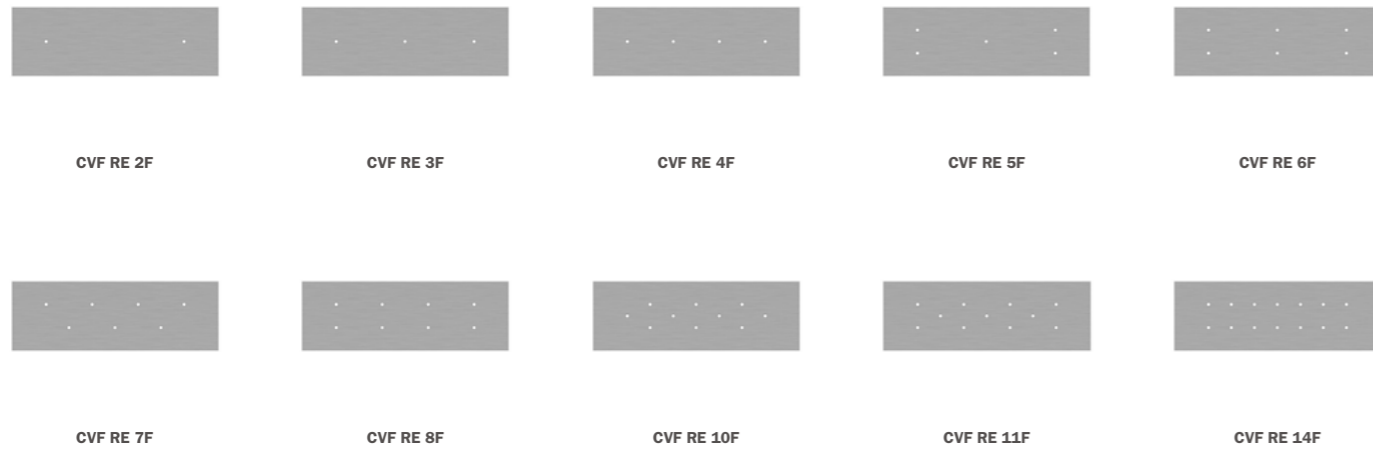

HOW TO COMPOSE THE PRODUCT CODE

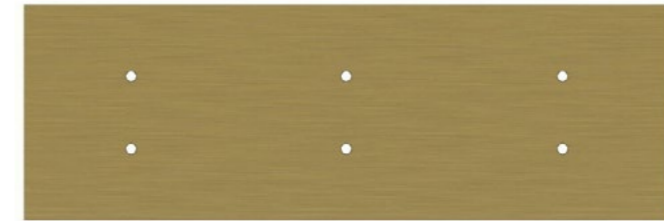

CVF **RE** **6F** **107**
Pre-drilled covers Rectangular Holes Decoration

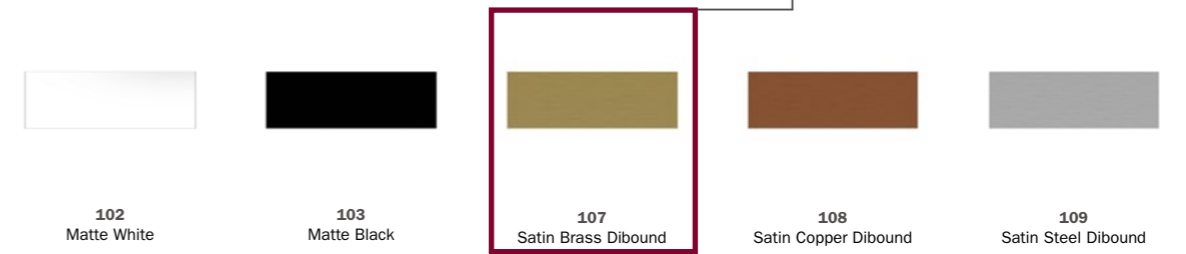

1.1 Un-drilled covers

The Rose-One un-drilled come in three different shapes: square, round and rectangular. And the squared and round versions are available in two different diameters, 200 and 400mm. Covers come in different designs and colors and are made in aluminum or dibond. Covers can be drilled following different kind of punching schemes: to drill the covers use our template.

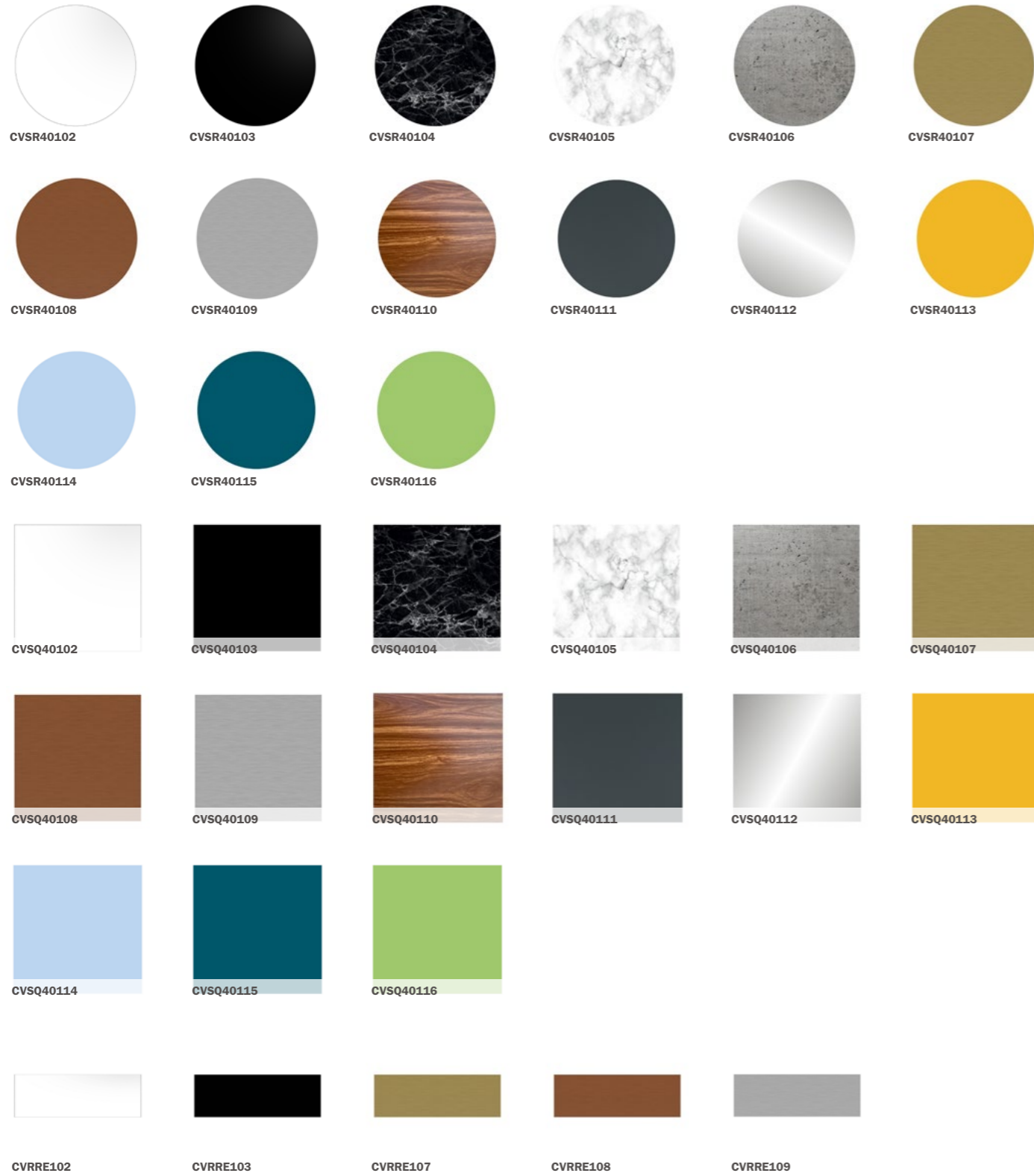

2. Base metal ceiling roses

The Rose-One system bases are available in black and white and in 3 versions, each suitable for the different shapes and sizes of Rose-One covers.

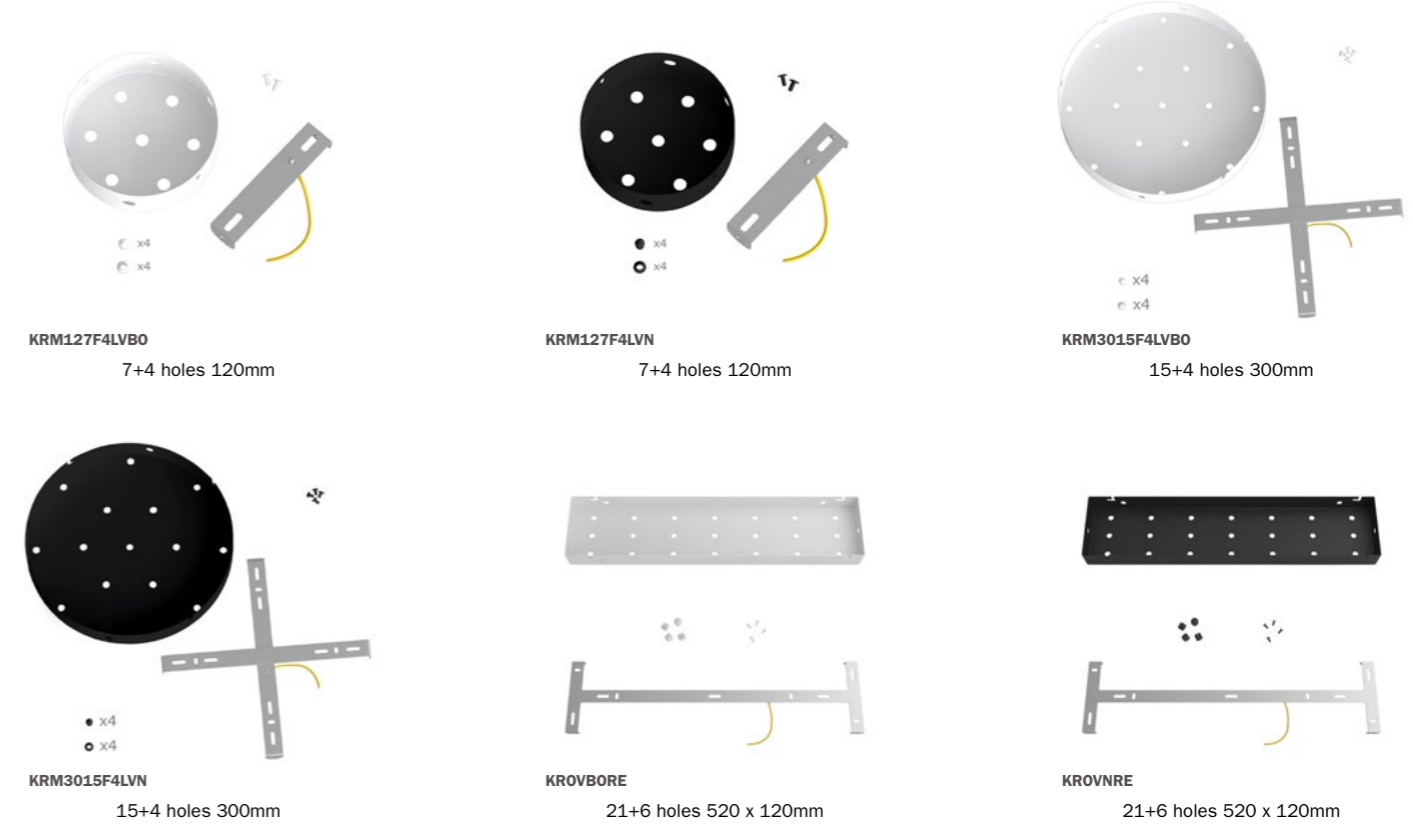

The Rose-One Template allows you to drill the un-drilled covers

3. Cable clamps

The flat shape and transparent color plastic cable clamps designed for Rose-One system allow covers clearly visible.



PC100SER04

Sold in packs of 100

Wooden templates to drill the covers yourself

These wooden templates allow you to drill any round, square or rectangular cover for Rose-One in your store with a common drill. The holes are numbered to facilitate drilling: if you want, you can use our legend to reproduce the most classic drilling patterns.

You can drill the round and squared covers with this template:



KDIMA-ROSE-ONE

You can drill the rectangular covers with this template:

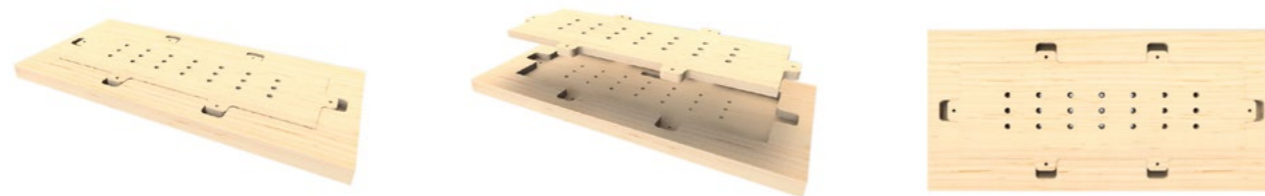

KDIMA-ROSE-ONE-RE

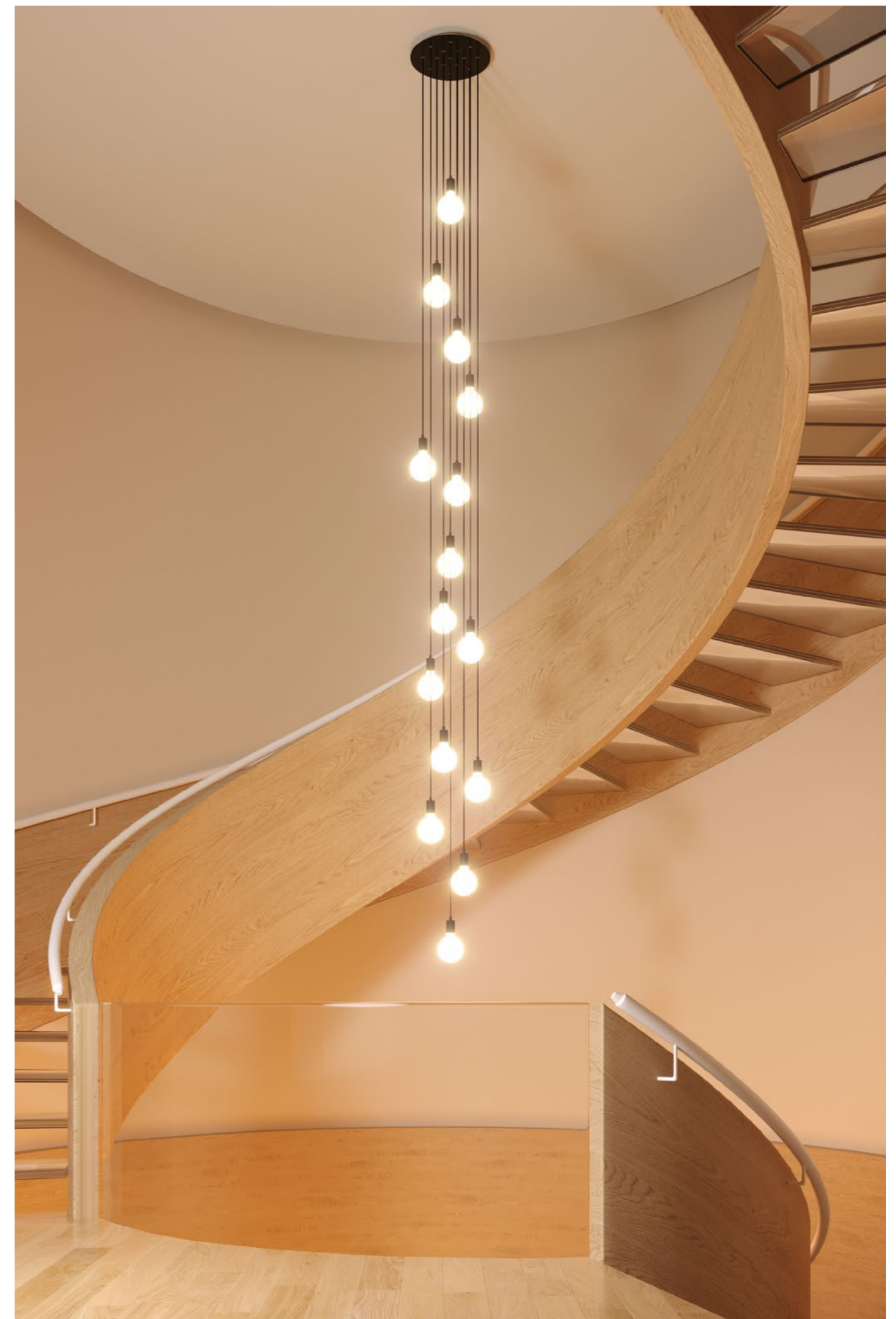



FLEX SYSTEM

INDOOR

When flexibility takes shape.

Flex System is ideal to create single and multi-fall pendant or wall lamps inspired by the most imaginative ideas, yours!

Be creative and design your own lighting system.

FLEX SYSTEM

Flex System is the lighting system for creating lamps in all the shapes and finishes your imagination can suggest. Creative Flex is a flexible extension tube covered in fabric that can be bent and adjusted with different twists and it's completed with a pair of metal terminals. Let your imagination run wild and create the most beautiful lamps inspired by your creativity with Creative Flex

1

3 Lengths

No matter your lighting needs, we're sure you can fulfil them with Creative Flex.

2

15 fabrics

The 15 coverings available are designed to suit any environment. We're sure you'll find one that suits your style - we love creative!

3

5 Terminals

To complete your Creative Flex, we have conceived 5 finishes for the metal terminal to match all 15 available coverings according to your taste.

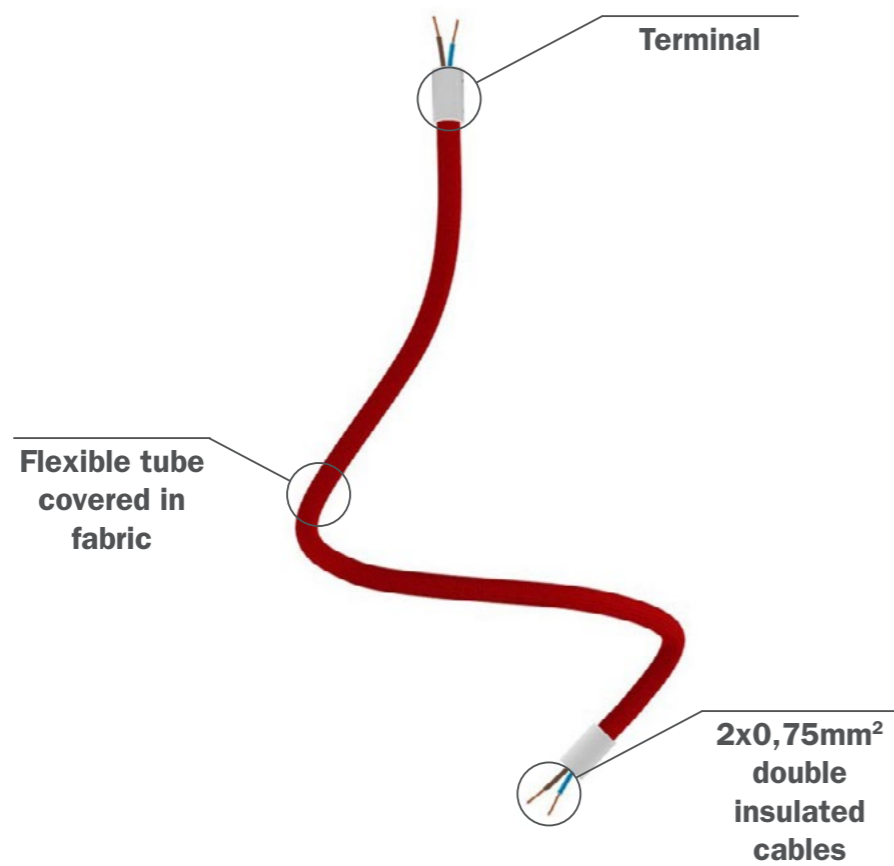

Creative Flex

The Flex is a flexible extension tube covered in fabric that thanks to its remarkable flexibility, allows to create customised lighting systems for any space. It is available in 3 lengths - 30 cm, 60 cm, 90 cm - and in 15 different colours.



30 cm	60 cm	90 cm	30 cm	60 cm	90 cm	30 cm	60 cm	90 cm
FLEX30RM01	FLEX60RM01	FLEX90RM01	FLEX30RM19	FLEX60RM19	FLEX90RM19	FLEX30RM75	FLEX60RM75	FLEX90RM75
FLEX30RM02	FLEX60RM02	FLEX90RM02	FLEX30RM20	FLEX60RM20	FLEX90RM20	FLEX30RZ04	FLEX60RZ04	FLEX90RZ04
FLEX30RM04	FLEX60RM04	FLEX90RM04	FLEX30RM72	FLEX60RM72	FLEX90RM72	FLEX30RZ22	FLEX60RZ22	FLEX90RZ22
FLEX30RM09	FLEX60RM09	FLEX90RM09	FLEX30RM73	FLEX60RM73	FLEX90RM73	FLEX30RZ24	FLEX60RZ24	FLEX90RZ24
FLEX30RM13	FLEX60RM13	FLEX90RM13	FLEX30RM74	FLEX60RM74	FLEX90RM74	FLEX30RZ30	FLEX60RZ30	FLEX90RZ30

Creative Terminals

Metal terminals for Flex System available in 5 finishes to match the FLEX extension tube and the colour of the ceiling rose.



	SERMF10VN
	SERMF10VBO
	SERMF10TIS
	SERMF10RAS
	SERMF10OTS

Creative Flex Kit

The Creative Flex kit includes a flex, the adjustable flexible tube, and a pair of metal terminals. We provide you with 225 options to create your Creative Flex Kit, but don't worry, your warehouse will also remain flexible: based on the requests of your customers, you can also purchase the different options individually.

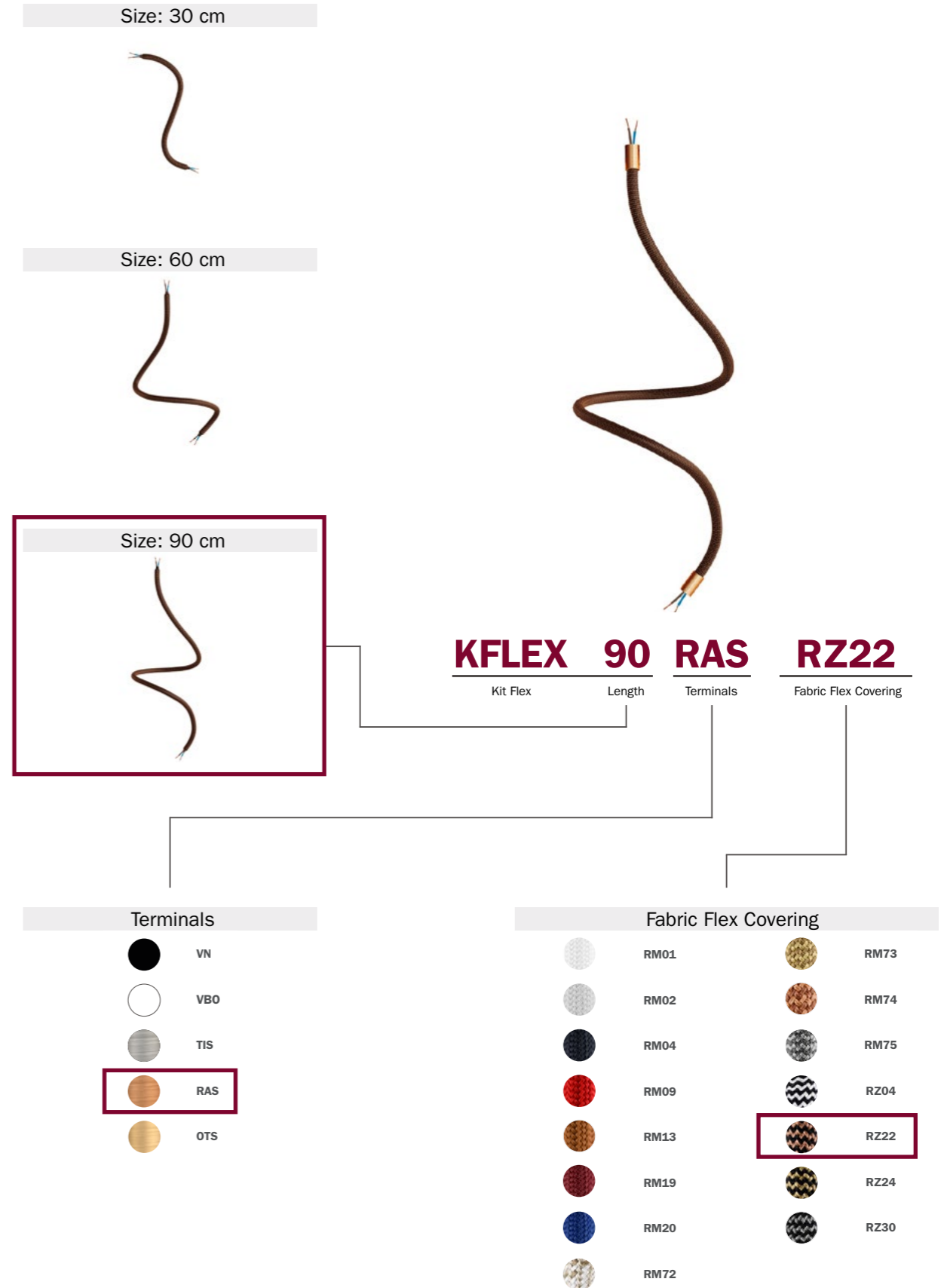

Creative Flex lamps

If you have a temporary creative block, choose one of our complete lamps Creative Flex solutions. With Creative Flex ceiling, wall or table lamps you can create the most original ideas, your own.



Flex 90cm

- APMFLVB090VBORM09
- APMFLRAS90RASRM74
- APMFL0TS90VNRZ22



Flex 60cm

- APMFLVB060VBORM72
- APMFLRAS60RASRM04
- APMFLTIS60TISR75



Flex 30cm, L 83mm, H 396mm

- APMFLVB030VBORM19
- APMFLVN30VNRM04
- APMFL0TS30VNR73



Flex 30cm, L 83mm, H 396mm

- APMFLGUVB030BORZ04
- APMFLGURAS30VNR74
- APMFLGUTIS30TISR75



L 120mm, H 694mm

- SPM3FLGUVB060VBORM01
- SPM3FLGU0TS600TSRZ24
- SPM3FLGUVN60VNR74



L 120mm, H 996mm

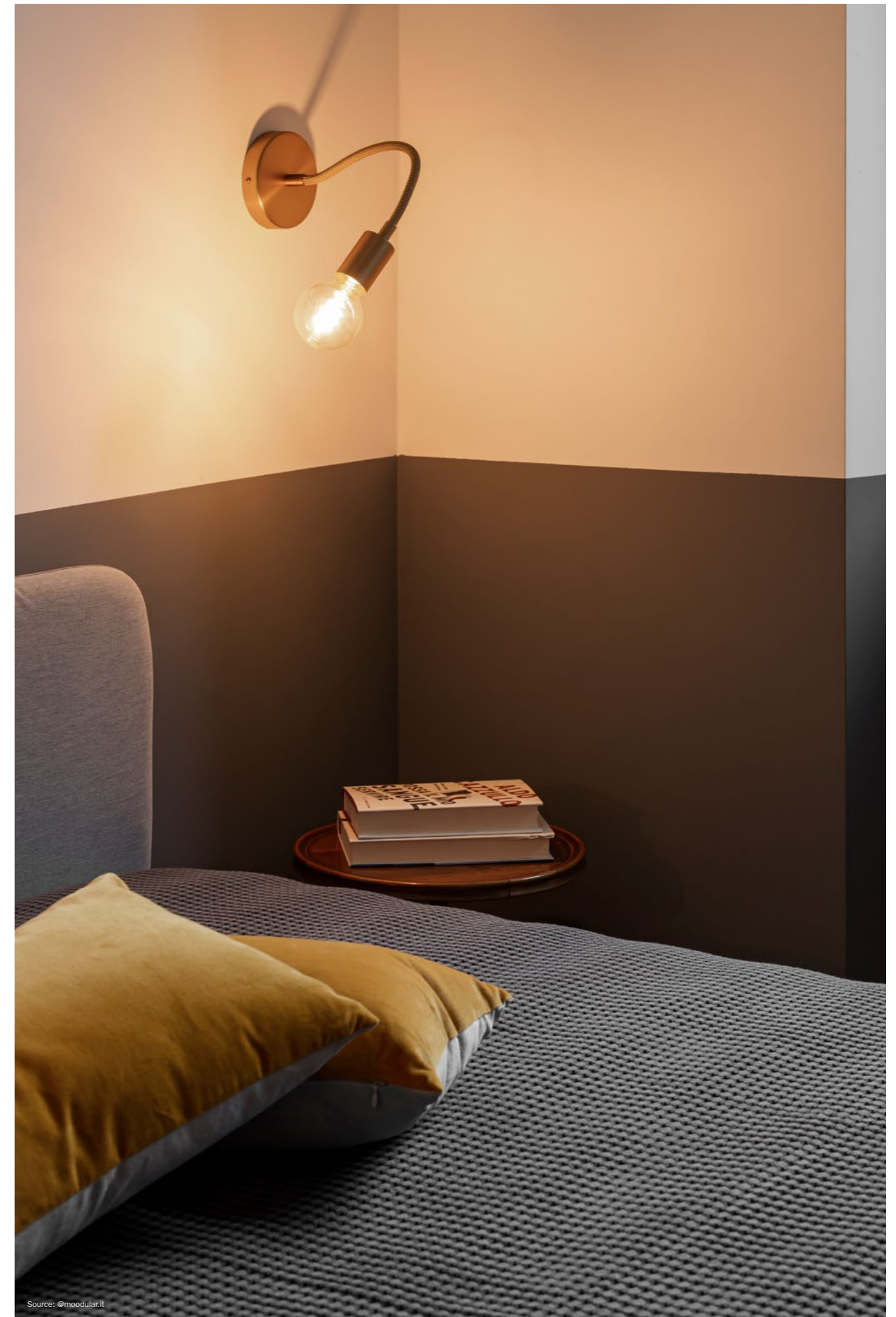

- SPM4FLGUTIS90TISR75
- SPM4FLGURAS90VNR74
- SPM4FLGUVN90VNR09



Source: @moodular.it





Flex 60cm, L 120mm, H 25mm

-  ABM21VBOFLVBORM72EUBRM01
-  ABM21TISFLTISR75EUTRM03
-  ABM21OTSFL0TSRM04EUNRM04



Flex 60cm, L 20mm, H 25mm

-  ABM21VNFL0TSRM04GUVNEUNRM42-L
-  ABM21RASFLRASRM04GURASEUNRM04-L
-  ABM21VNFVNR73GUOTSEUNRM04-L



Flex 90cm, L 45mm, H 75mm

-  ABSMFLVNR04GUVNEUNRM04-L
-  ABSMFLTISR75GUTISEUNRM04-L
-  ABSMFL0TSRM04GUOTSEUNRM04-L



SPOSTALUCE SYSTEM

INDOOR

*Take the light anywhere you want
with SPOSTALUCE.*

Install ceiling and wall lights to create
your own tailored lighting system,
even if there is no connection to the
electrical circuit.

SPOSTALUCE SYSTEM

1

Anywhere you want

It doesn't matter where the connection to the mains supply is located; all you need to do is connect the cables and then position Spostaluce anywhere on the wall.

Customisable

Create original and contemporary interior lighting designs on the walls and ceilings with the round and twisted electric cables and metal finishes of Spostaluce.

2

3

Choose your style

Minimal, vintage or industrial: each of the metal finishes available lets you create your preferred home decor style.



Source: @Eutopiarch

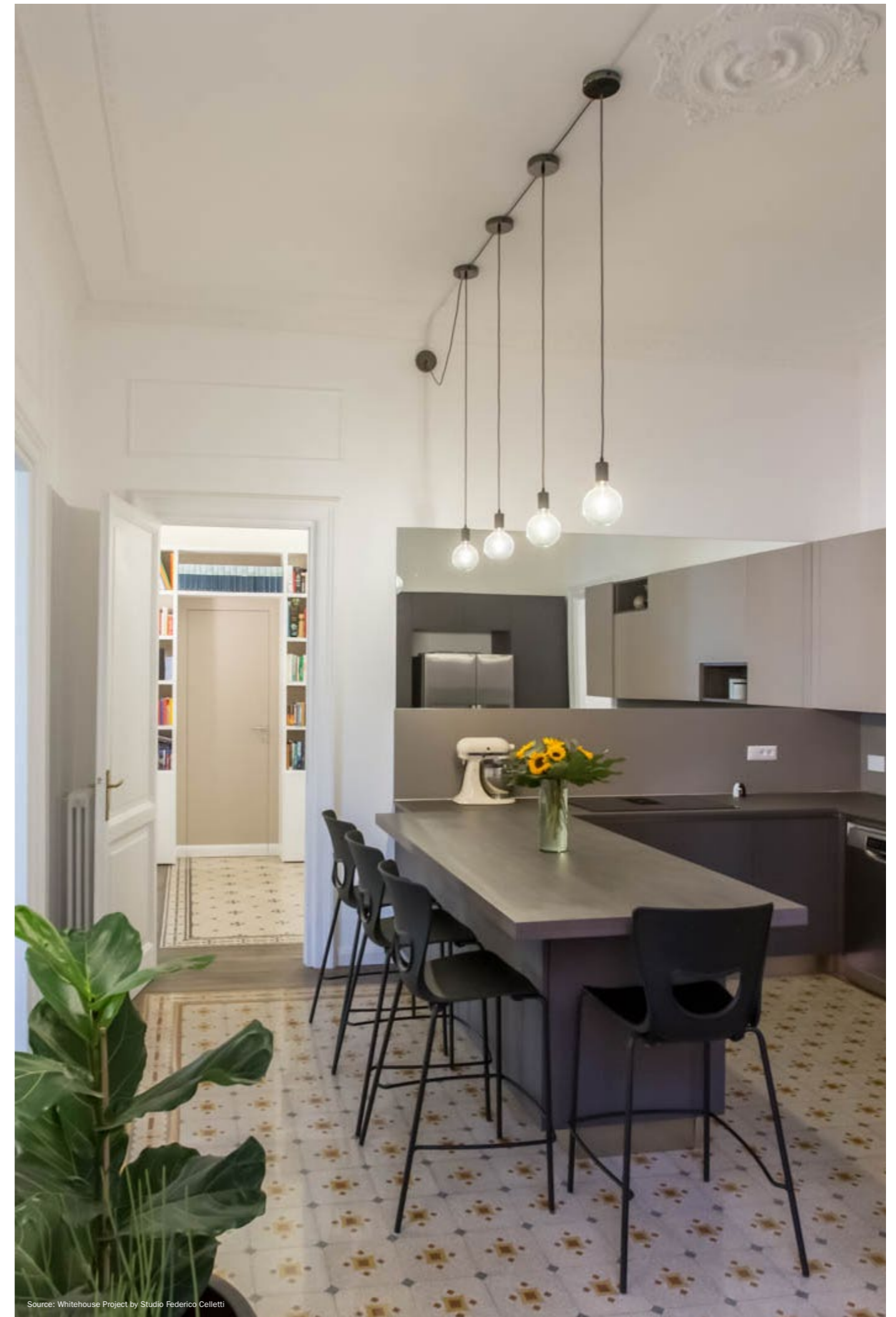

Source: Whitehouse Project by Studio Federico Celletti

Spotaluce Lamps

Spotaluce are the lights points that allow you to take the light source wherever you want, no longer having the issue of where the connection is to your electrical circuit. All you'll have to do is connect the Spotaluce lamp plug to the closest electrical socket and attach the lamp to the wall or ceiling of your room. It doesn't get any easier than that! Available in many versions and finishes, with Spotaluce it will be possible to create light installations both on the ceiling and on the wall.



- APM1FC2LVBOEUBRM01
- APM1FC2LVNEUNRM04
- APM1FC2LTISEUNRM26
- APM1FC2LRASEUNERM66
- APM1FC2LOTSEUNERM42



- APL1FC2L01EUTRD72
- APL1FC2L01EUTRN06



- adjustable**
Tilted up to 90° & rotated by 315°
- APM2FC2LVBOTCREUBRC01
 - APM2FC2LVNTBREUNRC04
 - APM2FC2LTISTTISEUTRM03
 - APM2FC2LRASTRASEUNERM66
 - APM2FC2LOTSTOTSEUNERM42



- adjustable**
Tilted up to 90° & rotated by 315°
- APL2FC2L01TCREUTRD73
 - APL2FC2L01TTISEUTTN06



- APM4FC2LVBOEXVBOEUBRC01
- APM4FC2LVNEXVNEUNRC04
- APM4FC2LTISEXTISEUNERC37
- APM4FC2LRASEXRASEUNT22
- APM4FC2LOTSEXOTSEUTRM04



- APL4FC2L01EXRUEUTRN06
- APL4FC2L01EXVBOEUBRD63



- APMFC2LFLGUVN30VNRM04EUNRM04-L
- APMFC2LFLGUTIS30TISR75EUBRM03-L
- APMFC2LFLGUOTS300TSRM04EUNRT41-L

Spotaluce modules

With our Spotaluce modules your walls and ceilings will be adorned by playful light patterns. Each module includes ceiling rose with 2 lateral holes and 3 meters of 2x0.75 textile cable that will allow you to connect multiple modules in sequence, transforming all your illumination ideas into a reality. Let your creativity run free!



- APM1FC2LVB3RM01
- APM1FC2LVN3RN03
- APM1FC2LCR3RN02
- APM1FC1LRA3RR11
- APM1FC2LG03RC04
- APM1FC2LBR3RL03



- APM2FC2LVBT3RM01
- APM2FC2LVNTB3RN03
- APM2FC2LG0TG03RC04
- APM2FC1LRATRA3RR11
- APM2FC2LCRTCR3RN02
- APM2FC2LBRTB3RL03



- APM1FC2LVBPBB3RM01
- APM1FC2LVNPPN3RN03
- APM1FC1LG0PM03RC04
- APM1FC1LRAPMR3RR11
- APM1FC1LCRPM3RN02
- APM1FC1LBRPMB3RL03



- APM1FC1LBRPMB3RL03
- APM2FC2LVNTBRPPN3RN03
- APM2FC1LG0TG0PM03RC04
- APM2FC1LRATRPMR3RR11
- APM2FC1LCRTCRPMA3RN02
- APM2FC1LBRTBRPMB3RL03



MAGNETICO® SYSTEM

INDOOR

Configure and reconfigure your lamps just as you like with MAGNETICO®.

Magnetico® is the lamp system that allows you to light your indoor spaces with complete flexibility.

MAGNETICO® SYSTEM

1

Mobile

The Magnetico® system is based on an E27 lamp holder that can be installed on any flat metal surface, allowing you to easily move the lamp any time you need.

Colourful

Magnetico® products are available in an extensive range of colours. From the brightest to the more neutral shades, there's a colour to suit everyone's style!

2

3

Flexible

Direct the light where it is needed by simply repositioning the lamp holder. Magnetico® adapts to your changing needs, and the possibilities are endless!



Magnetico®-Plug

It is a magnetic lamp holder able to adhere to any flat metal surface, no matter whether vertical or horizontal! Magnetico® -Plug is available in 9 different finishes and is equipped with a coloured 3 meter cable, switch, two-pole plug and E27 lampholder.



MPLUGVNR04



MPLUGVBOR01



MPLUGTISRM03



MPLUGRASRN06







MPLUGOTSRM04

Magnetico®-Base

It is a small metal base, available in 9 different finishes, which can be associated with Magnetico® -Plug to create movable table lamps. It is ideal as a portable and adjustable light for reading or working on a PC, but it can also illuminate a coffee table or a bookcase. Also equipped with a fold, it allows you to direct the light as desired.



-  MBASNER
-  MBASBIA
-  MBASTIS
-  MBASRAS
-  MBASOTS



SMART HOME SYSTEM

Your Smart Light Style

What's a smart ceiling rose? The ideal solution for those who live in a smart home or for those who want to start taking their first steps in home automation making their home "intelligent". Have fun activating the chandelier with a simple voice command, turn on the lights of your home automatically at sunset, create custom scenes and atmospheres by inserting your lamp in a group of lights: make any wall or ceiling lamp in your home smart with Creative-Cables!



Compatible with Amazon Alexa and Google Home

All the Creative-Cables smart ceiling roses are equipped with an ON/OFF switch already wired and ready to be easily connected to your electrical system, they can be controlled through the Smart Life app or connected to a voice assistant (they are compatible with Amazon Alexa and Google Home) and help you create lighting groups for custom scenes and atmospheres.



Smart ceiling roses

A smart ceiling rose is the "connected" version of a lighting rose: it can be used to create remotely controllable pendant, wall or ceiling lamps using an App or voice assistants. Choose the size of the ceiling rose (classic or XXL), the number of holes you need to create your lamp (up to 14 pendants!) and the finish that best matches your interior design style and have fun creating your own connected lamp!

Metal ø 120mm



Available finishes



Rose-One XXL 400mm



Available finishes



Available finishes

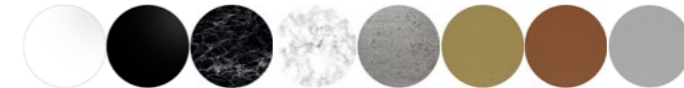

Wi-Fi Light Bulbs E27

A series of classic LED bulbs, but "smart" because they can be controlled remotely via the Smart Life app installed on any smartphone or tablet and compatible with major voice assistance systems such as Google Home and Amazon Alexa. Thanks to the E27 socket you can install our WiFi bulbs on any lamp or lampholder and make it smart.



DL552006
H 114mm, L 60mm
6W - 2700K - 700 Lm



DL552007
H 175mm, L 125mm
7W - 2700K - 806 Lm



DL552010
H 178mm, L 125mm
6,5W - 1800K/3000K - 806 Lm



DL552011
H 140mm, L 95mm
6,5W - 1800K/3000K - 806 Lm



DL552012
H 140mm, L 64mm
6,5W - 1800K/3000K - 806 Lm

COMPONENTS

LAMPS 218

CONFIGURATOR 234

CABLES	110
CEILING ROSES	130
LAMP HOLDERS	148
SPOTLIGHTS	160
LAMPSHADES	164
ACCESSORIES AND FIXTURES	176
ELECTRICITY	190
BULBS	196



Three generations of textile excellence put to the service of producing **the best covered cable in the world**

The **history of Creative-Cables** traces its roots back to the textile industry of the **Chieri** area in Piedmont, Italy, known for the renowned production of its “**textile trim shops**” since the early 1900s.

At that time, a fabric generically called “**mesh curtain**” was created with four intertwined threads and many holes, and was **produced with crochet machines** by the German company “Key”, the holder of the world patent.

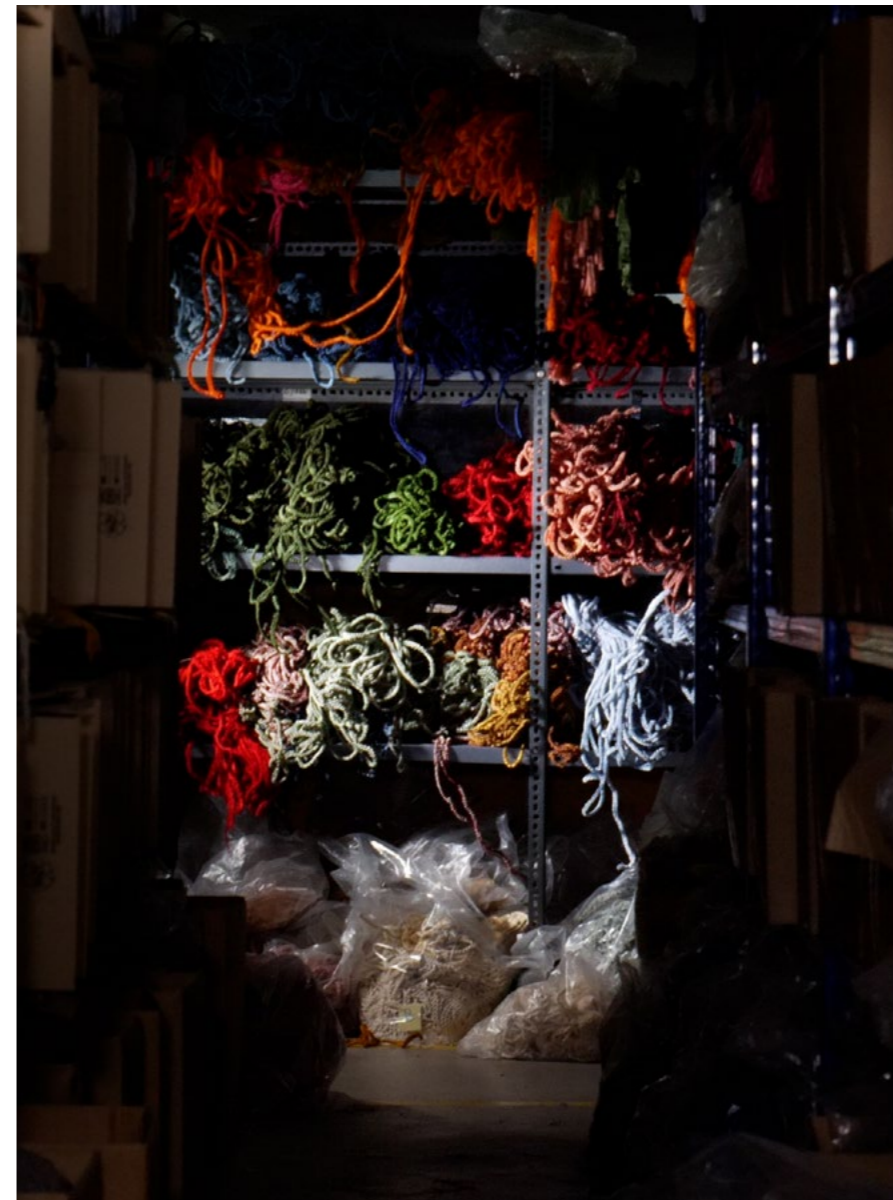

During the Second World War, Key was literally destroyed: but the resilience and drive of the people of Chieri, along with a pinch of luck and coincidence supported by a market demand did the rest to restore the trade.

It is **in this region** that we **manufacture our electrical fabric cables**, using the same technology underlying the textile trim production, leveraging a **priceless cultural heritage**.

LIGHTING CABLES

More than 150 colours, patterns, textures and surface effects for different uses, tastes or designs. Choose among the offered styles (round, twisted, nautical, large section or flat) to select what best suits your lighting project: they are incredibly flexible, because we use high quality PVC to avoid bulges or wrinkles. All of our lighting cables are IMQ-HAR certified, the highest quality standard in Europe. Every single product is designed and Made in Italy.

Round silk-effect cables

Silk-effect cables have a bright solid finish, which is elegant yet informal. Shiny as silk, they can bring colour wherever needed.

Specifications:

H03VV-F 300/300Vac 2x0,75mm² or 3x0,75mm²
 Flex Round IMQ-HAR Cable DOUBLE INSULATION under textile braid.
 Standard reference: EN 50525-2-11, Low Voltage European Directive N° 2014/35/EU,
 IMQ-HAR approval No. A0643, DoP No. 0008.
 Diameter: 6,2mm 2x0,75mm² or 6,6mm 3x0,75mm²
 The cable is sold by the meter, multiple orders will be delivered in one piece up to a maximum of 50 meters in length.
 UL listed 3 cores AWG18 cable is also available
MADE IN ITALY

IEMMEQU <HAR>
 N° A0643, DoP N° 0008

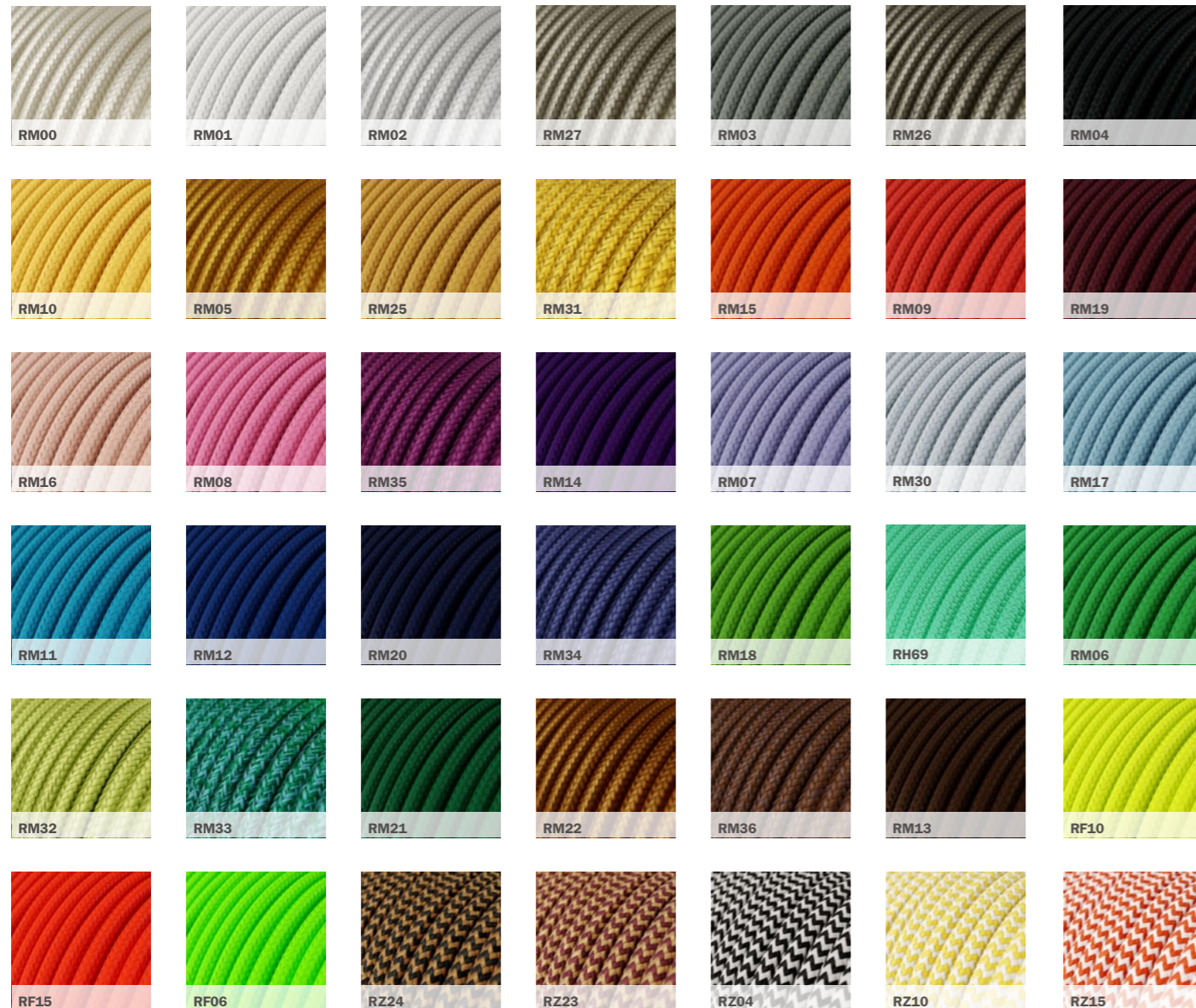
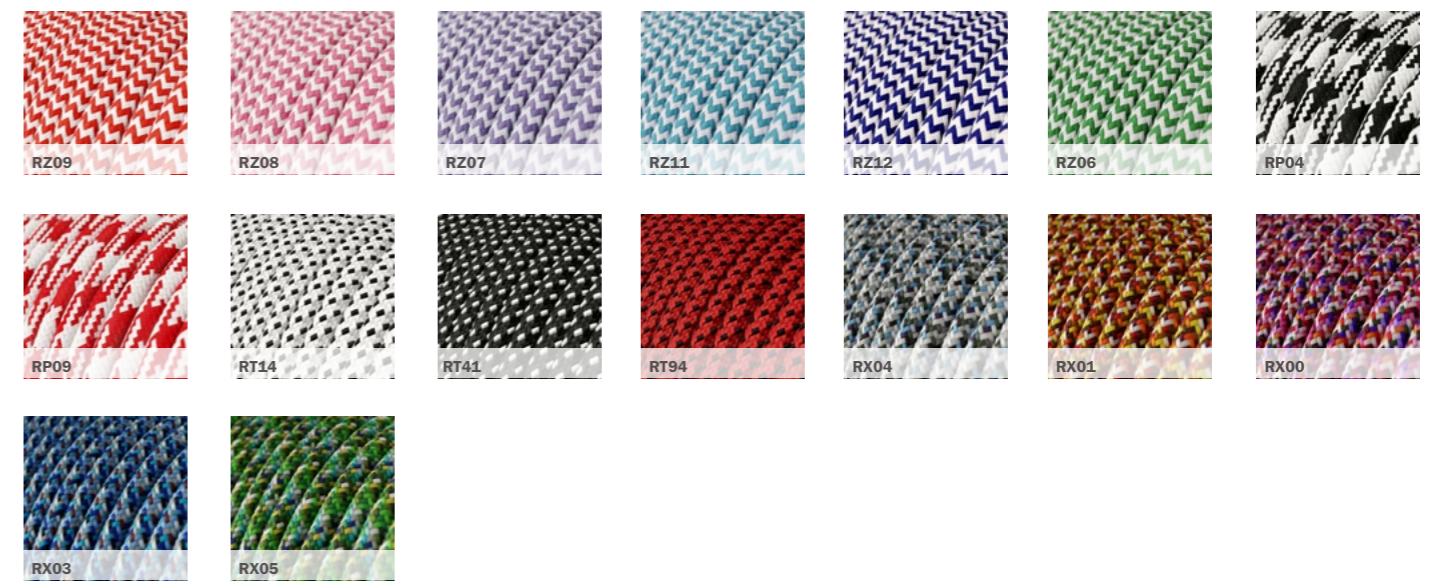

	2x0.75	3x0.75		2x0.75	3x0.75		2x0.75	3x0.75
	XZ2RM00	XZ3RM00		XZ2RM17	XZ3RM17		XZ2RZ10	XZ3RZ10
	XZ2RM01	XZ3RM01		XZ2RM11	XZ3RM11		XZ2RZ15	XZ3RZ15
	XZ2RM02	XZ3RM02		XZ2RM12	XZ3RM12		XZ2RZ09	XZ3RZ09
	XZ2RM27	XZ3RM27		XZ2RM20	XZ3RM20		XZ2RZ08	XZ3RZ08
	XZ2RM03	XZ3RM03		-	XZ3RM34		XZ2RZ07	XZ3RZ07
	XZ2RM26	XZ3RM26		XZ2RM18	XZ3RM18		XZ2RZ11	XZ3RZ11
	XZ2RM04	XZ3RM04		XZ2RH69	XZ3RH69		XZ2RZ12	XZ3RZ12
	XZ2RM10	XZ3RM10		XZ2RM06	XZ3RM06		XZ2RZ06	XZ3RZ06
	XZ2RM05	XZ3RM05		-	XZ3RM32		XZ2RP04	XZ3RP04
	XZ2RM25	XZ3RM25		-	XZ3RM33		XZ2RP09	XZ3RP09
	-	XZ3RM31		XZ2RM21	XZ3RM21		XZ2RT14	XZ3RT14
	XZ2RM15	XZ3RM15		XZ2RM22	XZ3RM22		XZ2RT41	XZ3RT41
	XZ2RM09	XZ3RM09		-	XZ3RM36		XZ2RT94	XZ3RT94
	XZ2RM19	XZ3RM19		XZ2RM13	XZ3RM13		XZ2RX04	XZ3RX04
	XZ2RM16	XZ3RM16		XZ2RF10	XZ3RF10		XZ2RX01	XZ3RX01
	XZ2RM08	XZ3RM08		XZ2RF15	XZ3RF15		XZ2RX00	XZ3RX00
	-	XZ3RM35		XZ2RF06	XZ3RF06		XZ2RX03	XZ3RX03
	XZ2RM14	XZ3RM14		XZ2RZ24	XZ3RZ24		XZ2RX05	XZ3RX05
	XZ2RM07	XZ3RM07		XZ2RZ23	XZ3RZ23			
	XZ2RM30	XZ3RM30		XZ2RZ04	XZ3RZ04			

Round cotton cables

Our cotton cables come in both pastel colours and warm tones. Cotton has a natural look and matches cozy and minimal environments. Ideal for those who prefer a “raw” feeling.

Specifications:

H03VV-F 300/300V_{ac} 2x0,75mm² or 3x0,75mm²

Flex Round IMQ-HAR Cable DOUBLE INSULATION under textile braid.

Standard reference: EN 50525-2-1.1, Low Voltage European Directive N° 2014/35/EU, IMQ-HAR approval No. A0643, DoP No. 0008.

Diameter: 6,2mm 2x0,75mm² or 6,6mm 3x0,75mm²

The cable is sold by the meter, multiple orders will be delivered in one piece up to a maximum of 50 meters in length.

UL listed 3 cores AWG18 cable is also available

MADE IN ITALY

IEMMEQU <HAR>
N° A0643, DoP N° 0008

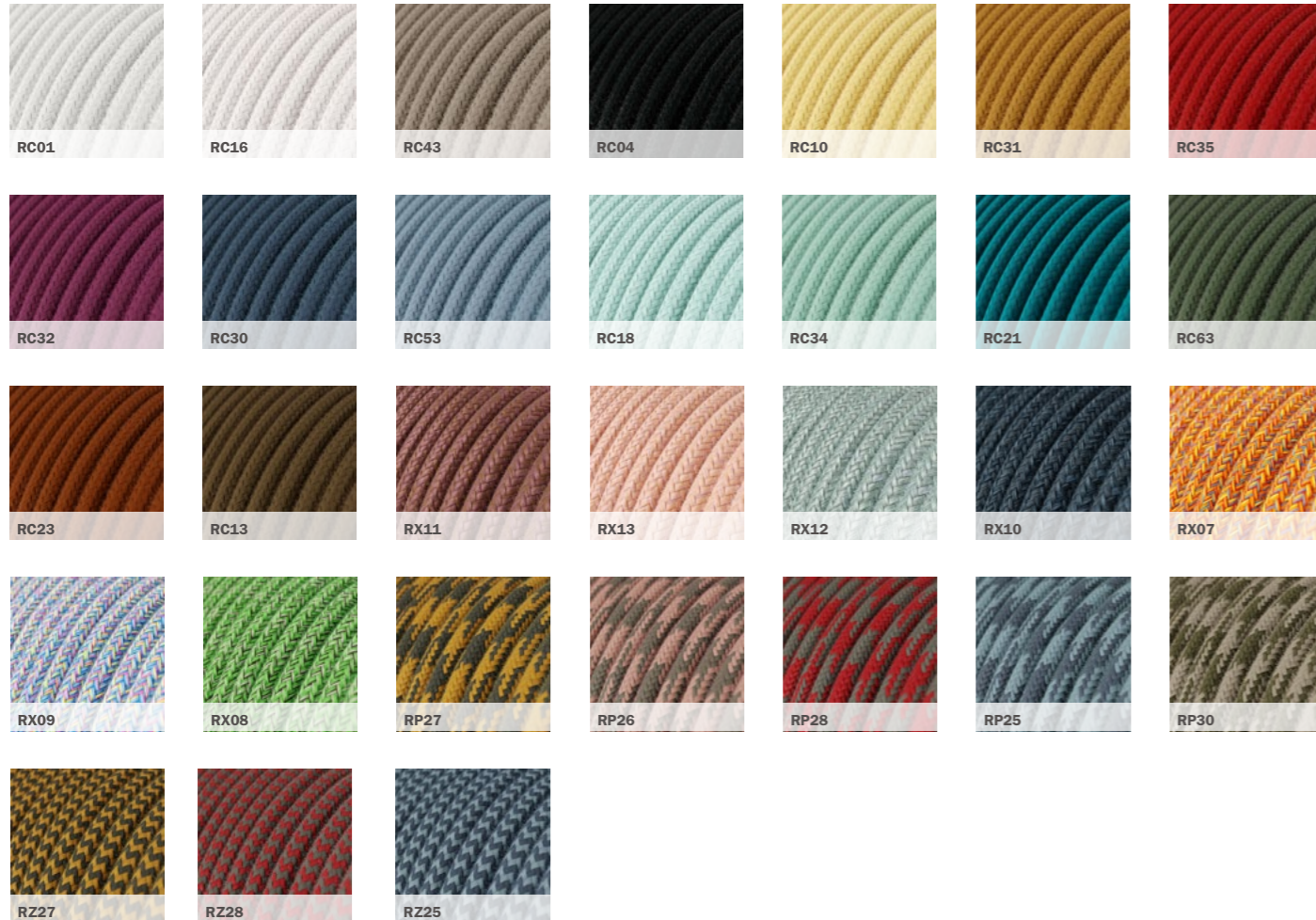

2x0.75

3x0.75



2x0.75

3x0.75



2x0.75

3x0.75



Round metal cables

A copper layer partially covers a black electrical cable, for an incredibly shiny effect. We love it for that special industrial yet very chic touch.

Specifications:

H03VV-F 300/300V_{ac} 3x0,75mm²

Flex Round IMQ-HAR Cable DOUBLE INSULATION under textile braid.

Standard reference: EN 50525-2-1.1, Low Voltage European Directive No. 2014/35/EU,

IMQ-HAR approval No. A0643, DoP No. 0008.

Diameter: 6,6mm

The cable is sold by the meter, multiple orders will be delivered in one piece up to a maximum of 50 meters in length.

MADE IN ITALY

IEMMEQU <HAR>
N° A0643, DoP N° 0008



3x0.75

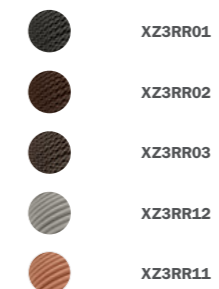

Round natural cables

Linen and jute bring warmth and coziness to any room: they are the match for furniture in natural materials such as wood and earth colours. You will love their unmistakable “coarse” and rustic touch.

Specifications:

H03VV-F 300/300Vac 2x0,75mm² or 3x0,75mm²

Flex Round IMQ-HAR Cable DOUBLE INSULATION under textile braid.

Standard reference: EN 50525-2-11, Low Voltage European Directive N° 2014/35/EU,

IMQ-HAR approval No. A0643, DoP No. 0008.

Diameter: 6,2mm 2x0,75mm² or 6,6mm 3x0,75mm²

The cable is sold by the meter, multiple orders will be delivered in one piece up to a maximum of 50 meters in length.

UL listed 3 cores AWG18 cable is also available

MADE IN ITALY

IEMMEQU <HAR>
N° A0643, DoP N° 0008

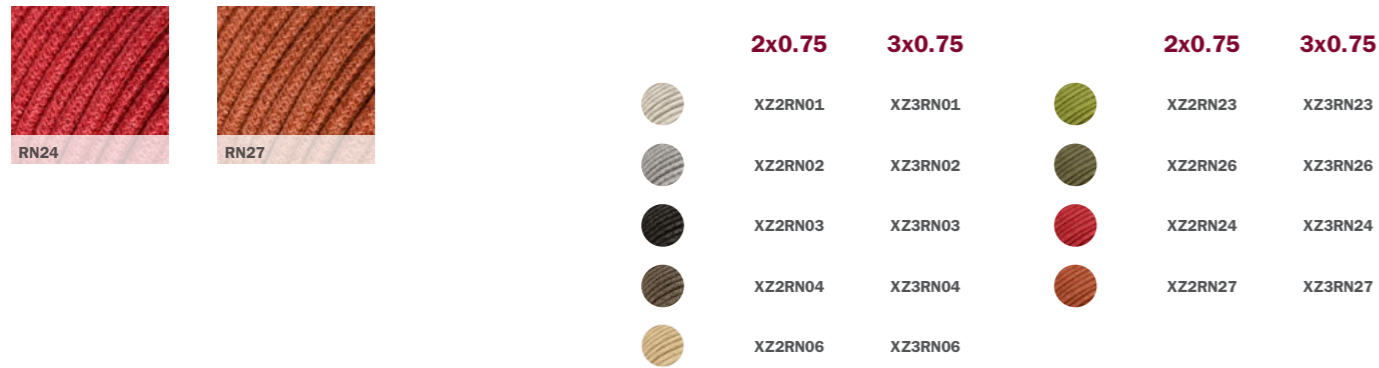
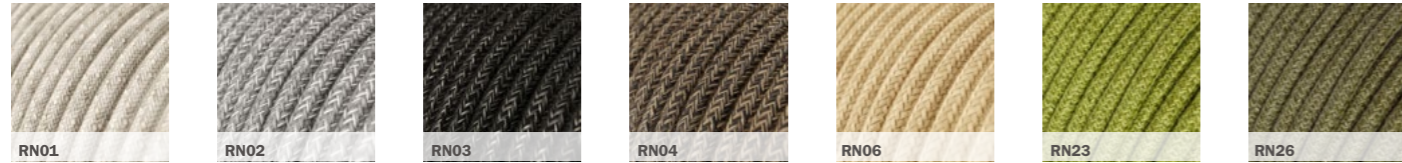

Round glitter cables

Take plain cotton fabric, add some shimmering thread and you'll get a glamorous cable for your lamp.

Specifications:

H03VV-F 300/300Vac 2x0,75mm² or 3x0,75mm²

Flex Round IMQ-HAR Cable DOUBLE INSULATION under textile braid.

Standard reference: EN 50525-2-11, Low Voltage European Directive N° 2014/35/EU,

IMQ-HAR approval No. A0643, DoP No. 0008.

Diameter: 6,2mm 2x0,75mm² or 6,6mm 3x0,75mm²

The cable is sold by the meter, multiple orders will be delivered in one piece up to a maximum of 50 meters in length.

UL listed 3 cores AWG18 cable is also available

MADE IN ITALY

IEMMEQU <HAR>
N° A0643, DoP N° 0008

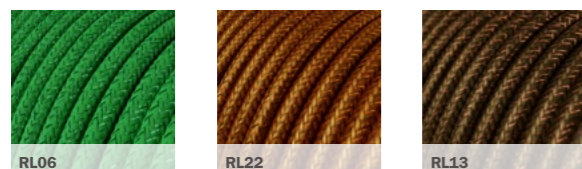
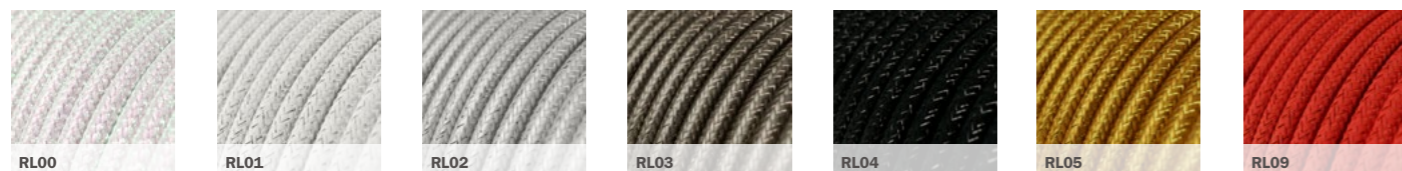

Round mixed cables

Not only colours can be mixed, but fabrics too! In this small selections, linen, cotton, glitters are put together to create some totally new patterns.

Specifications:

H03VV-F 300/300Vac 2x0,75mm² or 3x0,75mm²

Flex Round IMQ-HAR Cable DOUBLE INSULATION under textile braid.

Standard reference: EN 50525-2-11, Low Voltage European Directive N° 2014/35/EU,

IMQ-HAR approval No. A0643, DoP No. 0008.

Diameter: 6,2mm 2x0,75mm² or 6,6mm 3x0,75mm²

The cable is sold by the meter, multiple orders will be delivered in one piece up to a maximum of 50 meters in length.

UL listed 3 cores AWG18 cable is also available

MADE IN ITALY

IEMMEQU <HAR>
N° A0643, DoP N° 0008

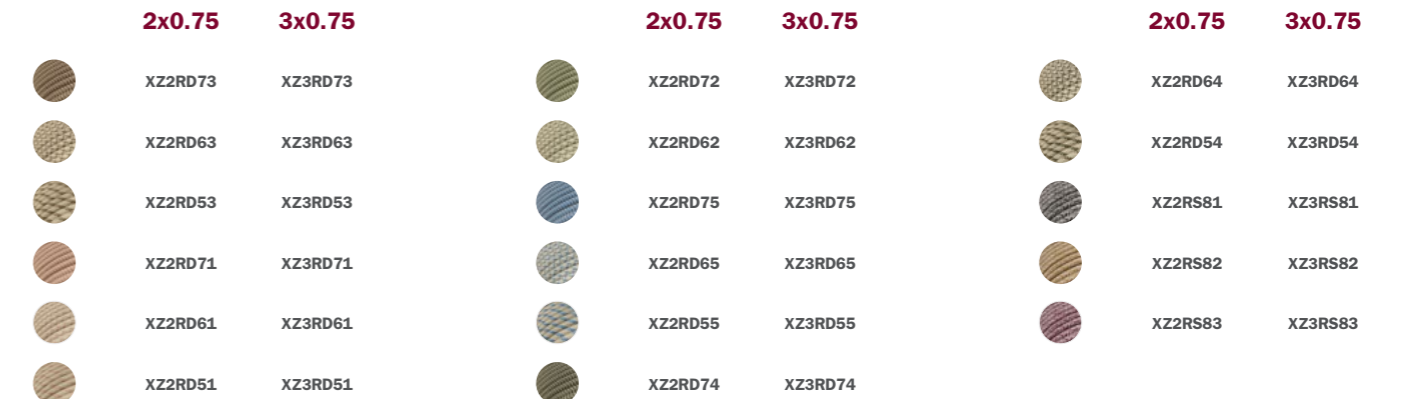
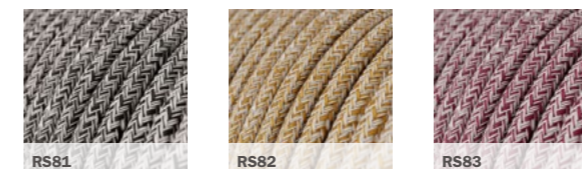

Twisted silk-effect cables

Ideal for lighting projects with a modern and elegant look, our silk-effect cables offer a bright and shiny finish. Silk-effect cables have a bright solid finish, which is elegant yet informal.

Specifications:

FRRTX 300/300V_{AC} 2x0,75mm² or 3x0,75mm²

Flex Twisted Visible Spiral Cable DOUBLE INSULATION (additional transparent sheath), braided woven cloth textile sleeve.

Standard reference: Low Voltage European Directive No. 2014/35/EU

Diameter: 6,2mm 2x0,75mm² or 6,6mm 3x0,75mm²

The cable is sold by the meter, multiple orders will be delivered in one piece up to a maximum of 50 meters in length.

MADE IN ITALY

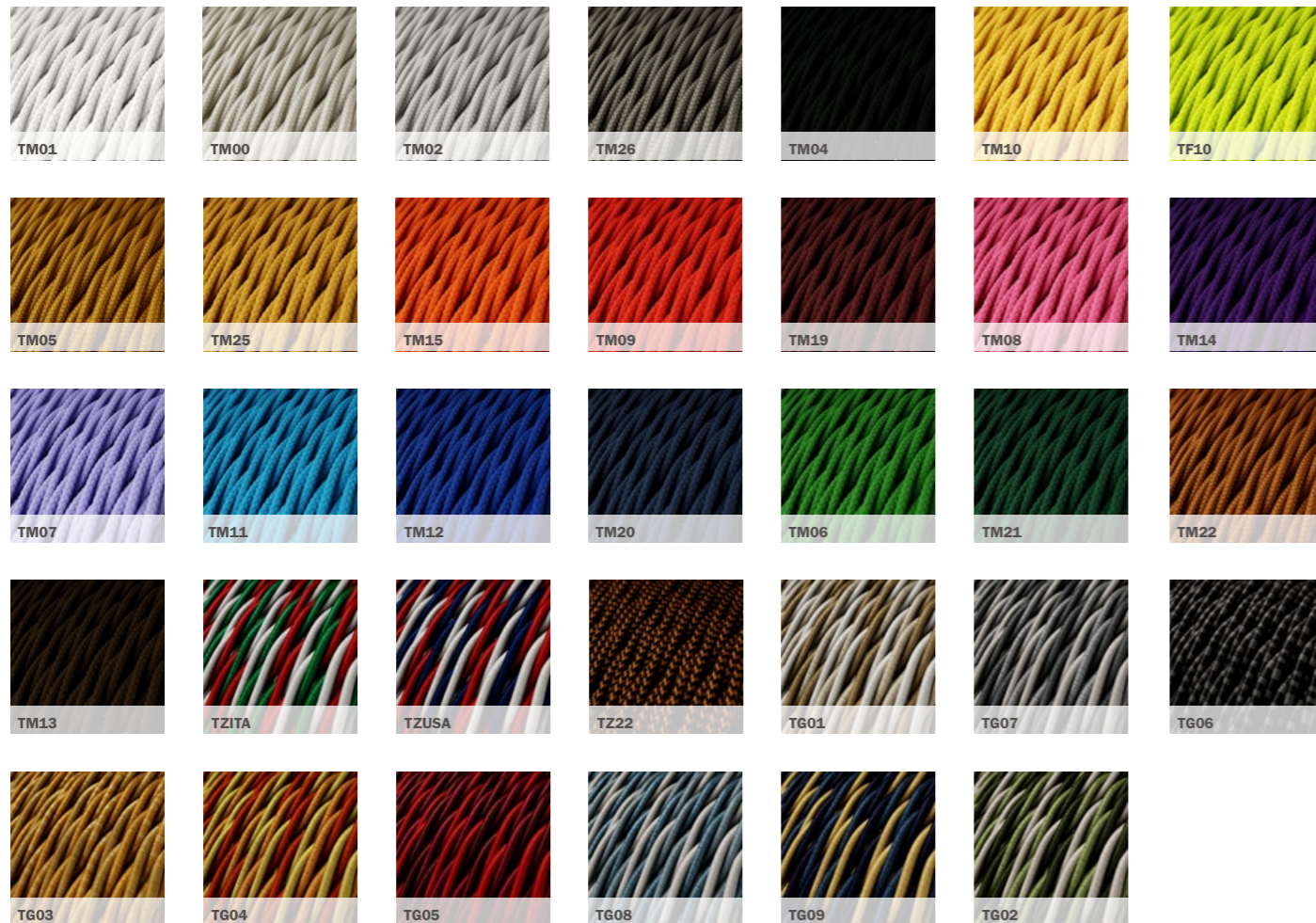

2x0.75

3x0.75



2x0.75

3x0.75



3x0.75

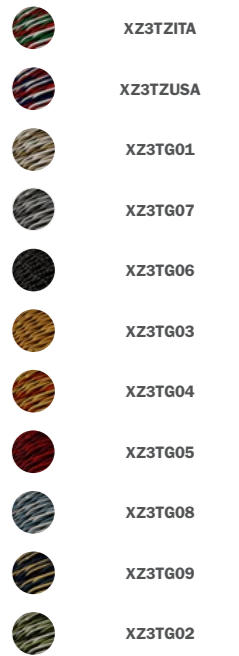

Twisted cotton cables

Thanks to their special twisted texture, they look like braids: but believe us, they are real electric cables! Cotton has a natural look and matches cozy and minimal environments. Ideal for those who prefer a "raw" feeling.

Specifications:

FRRTX 300/300V_{AC} 2x0,75mm² or 3x0,75mm²

Flex Twisted Visible Spiral Cable DOUBLE INSULATION (additional transparent sheath), braided woven cloth textile sleeve.

Standard reference: Low Voltage European Directive No. 2014/35/EU

Diameter: 6,2mm 2x0,75mm² or 6,6mm 3x0,75mm²

The cable is sold by the meter, multiple orders will be delivered in one piece up to a maximum of 50 meters in length.

MADE IN ITALY

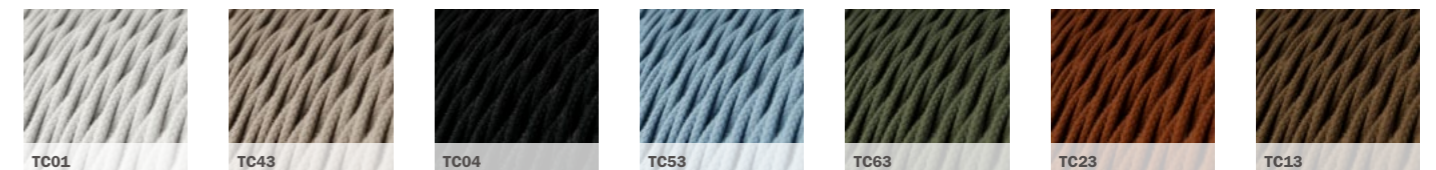
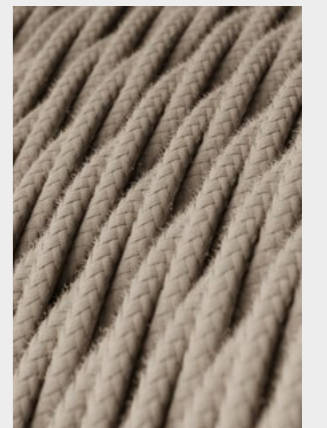

2x0.75

3x0.75



Twisted natural cables

Thanks to their special twisted texture, they look like braids: but believe us, they are real electric cables! Linen and jute bring warmth and coziness to any room: they perfectly match furniture in natural materials such as wood and earth colours.

Specifications:

FRRTX 300/300Vac 2x0,75mm² or 3x0,75mm²

Flex Twisted Visible Spiral Cable DOUBLE INSULATION (additional transparent sheath), braided woven cloth textile sleeve.

Standard reference: Low Voltage European Directive No. 2014/35/EU

Diameter: 6,2mm 2x0,75mm² or 6,6mm 3x0,75mm²

The cable is sold by the meter, multiple orders will be delivered in one piece up to a maximum of 50 meters in length.

MADE IN ITALY



TN01

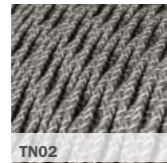

TN02

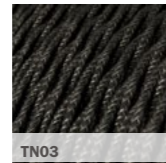

TN03

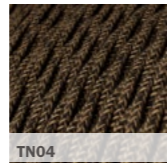

TN04



TN06



TN07

2x0.75

3x0.75



XZ2TN01

XZ3TN01

XZ2TN02

XZ3TN02

XZ2TN03

XZ3TN03

XZ2TN04

XZ3TN04

XZ2TN06

XZ3TN06

XZ3TN07



Vertigo cables

These cables are braided with a peculiar pattern that cannot be found in other cables of our assortment. The effect is obtained by mixing coloured and transparent threads hereby resulting in some astonishing effects! Some of these cables are made out of natural fibres such as cotton, jute or linen; others are called "HD" because of their vivid and highly defined colours.

Specifications:

H03VV-F 300/300Vac 2x0,75mm² or 3x0,75mm²

Flex Round IMQ-HAR Cable DOUBLE INSULATION under textile braid

Standard reference: EN 50525-2-11, Low Voltage European Directive No. 2014/35/EU

IMQ-HAR approval No. A0643, DoP No. 0008

Diameter: 6,2mm 2x0,75mm² or 6,6mm 3x0,75mm²

Technology and design of Vertigo cables registered by Elexa Cavi.

Vertigo cables are exclusively distributed worldwide by Creative-Cables

The cable is sold by the meter, multiple orders will be delivered in one piece up to a maximum of 50 meters in length.

MADE IN ITALY

IEMMEQU <HAR>
N° A0643, DoP N° 0008

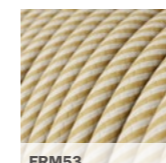

ERM53

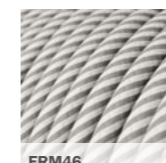

ERM46

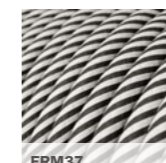

ERM37



ERM38

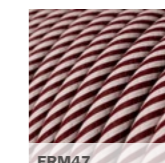

ERM47

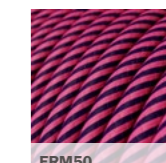

ERM50



ERM52

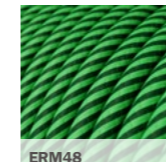

ERM48

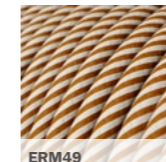

ERM49

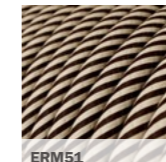

ERM51

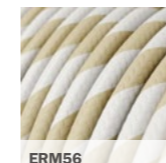

ERM56

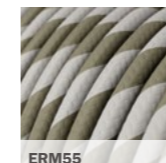

ERM55

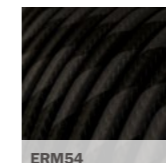

ERM54

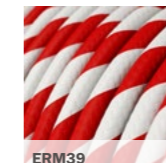

ERM39

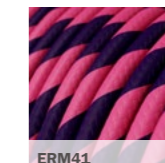

ERM41

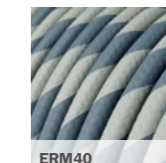

ERM40

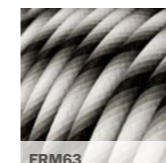

ERM63



ERM60

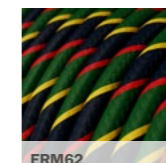

ERM62

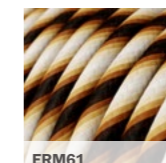

ERM61



ERM68

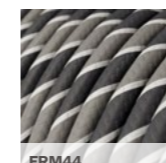

ERM44

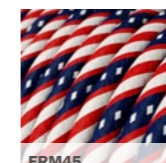

ERM45

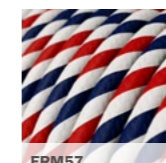

ERM57

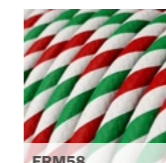

ERM58

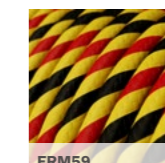

ERM59

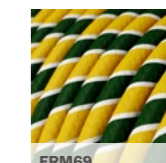

ERM69

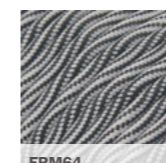

ERM64



ERM67

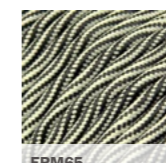

ERM65

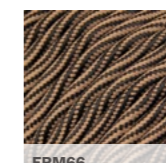

ERM66

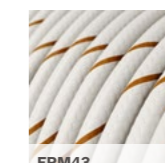

ERM43

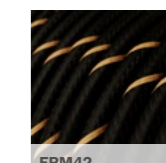

ERM42

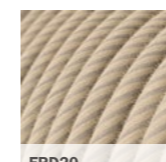

ERD20

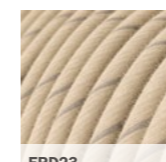

ERD23

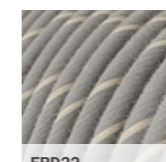

ERD22

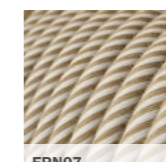

ERN07

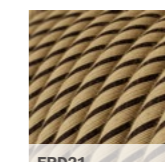

ERD21

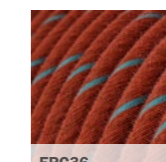

ERC36

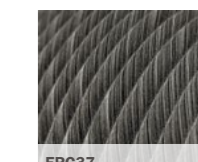

ERC37

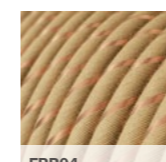

ERR04

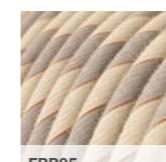

ERR05

2x0.75		3x0.75		2x0.75		3x0.75		2x0.75		3x0.75	
	XZ2ERM53		XZ3ERM53		XZ2ERM41		XZ3ERM41		XZ2ERM67		XZ3ERM67
	XZ2ERM46		XZ3ERM46		XZ2ERM40		XZ3ERM40		XZ2ERM65		XZ3ERM65
	XZ2ERM37		XZ3ERM37		XZ2ERM63		XZ3ERM63		XZ2ERM66		XZ3ERM66
	XZ2ERM38		XZ3ERM38		XZ2ERM60		XZ3ERM60		XZ2ERM43		XZ3ERM43
	XZ2ERM47		XZ3ERM47		XZ2ERM62		XZ3ERM62		XZ2ERM42		XZ3ERM42
	XZ2ERM50		XZ3ERM50		XZ2ERM61		XZ3ERM61		XZ2ERD20		XZ3ERD20
	XZ2ERM52		XZ3ERM52		XZ2ERM68		XZ3ERM68		XZ2ERD23		XZ3ERD23
	XZ2ERM48		XZ3ERM48		XZ2ERM44		XZ3ERM44		XZ2ERD22		XZ3ERD22
	XZ2ERM49		XZ3ERM49		XZ2ERM45		XZ3ERM45		XZ2ERN07		XZ3ERN07
	XZ2ERM51		XZ3ERM51		XZ2ERM57		XZ3ERM57		XZ2ERD21		XZ3ERD21
	XZ2ERM56		XZ3ERM56		XZ2ERM58		XZ3ERM58		XZ2ERC36		XZ3ERC36
	XZ2ERM55		XZ3ERM55		XZ2ERM59		XZ3ERM59		XZ2ERC37		XZ3ERC37
	XZ2ERM54		XZ3ERM54		XZ2ERM69		XZ3ERM69		-		XZ3ERR04
	XZ2ERM39		XZ3ERM39		XZ2ERM64		XZ3ERM64		-		XZ3ERR05

Marlene twisted lighting cable covered in hairy-effect fabric

Specifications:

Fabric-covered hairy-effect lighting cable
 FRRTX 300/300V 2x0,75 or 3x0,75 depending on the version chosen
 CE certified
 Double insulation (additional transparent sheathing)
 CEI 20-20 CEI 20-35 RoHS compliant
 Diameter: 6,2 mm 2x0,75 or 6,6 mm 3x0,75

MADE IN ITALY



XZ2TP01



XZ2TP13



XZ2TP04



XZ2TP06

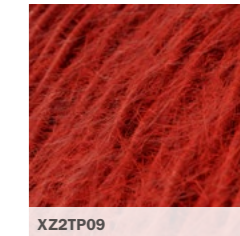

XZ2TP09

EXTRA LOW VOLTAGE CABLES

Two-pin Extra Low Voltage electrical cable in white extra-flexible silicone covered in fabric. The cable is 3.5 mm in diameter (approximately 4 mm covered) and has 2 copper conductors covered in black and red silicone rubber with a cross-section of 0.35 mm².

Extra low voltage cables

Caution! Do not use for mains voltage and halogen bulbs.

Specifications:

Flexible bipolar cable insulated with white silicone
 External diameter 3.8 mm
 2 copper conductors coated with black and red rubber section 0.35mm
 Rated voltage 300/500 V
 Test voltage 2kV
 IEC EN 60228 Class 5
 IEC EN 60754-1/2
 The size and structure of the cable make it suitable for LED applications with a voltage of less than 48V.

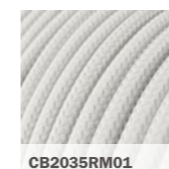

CB2035RM01

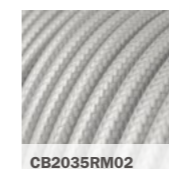

CB2035RM02

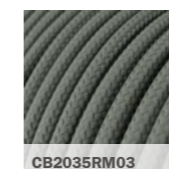

CB2035RM03

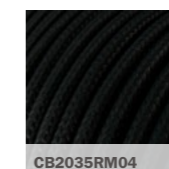

CB2035RM04

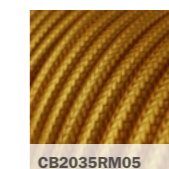

CB2035RM05

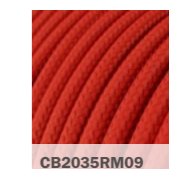

CB2035RM09

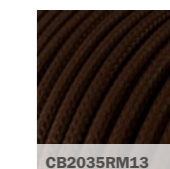

CB2035RM13

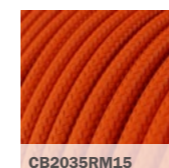

CB2035RM15

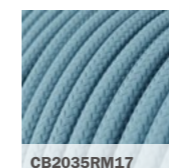

CB2035RM17

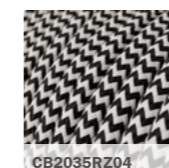

CB2035RZ04

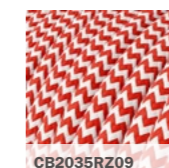

CB2035RZ09

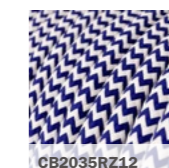

CB2035RZ12

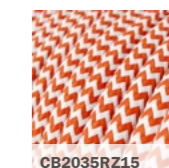

CB2035RZ15

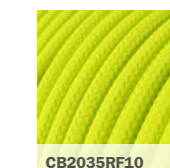

CB2035RF10

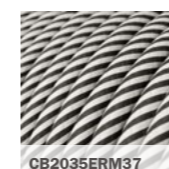

CB2035ERM37

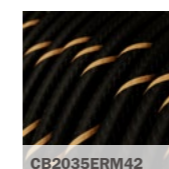

CB2035ERM42

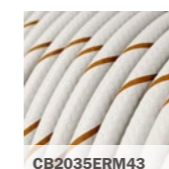

CB2035ERM43

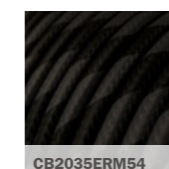

CB2035ERM54

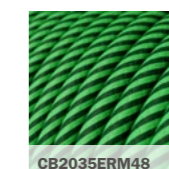

CB2035ERM48

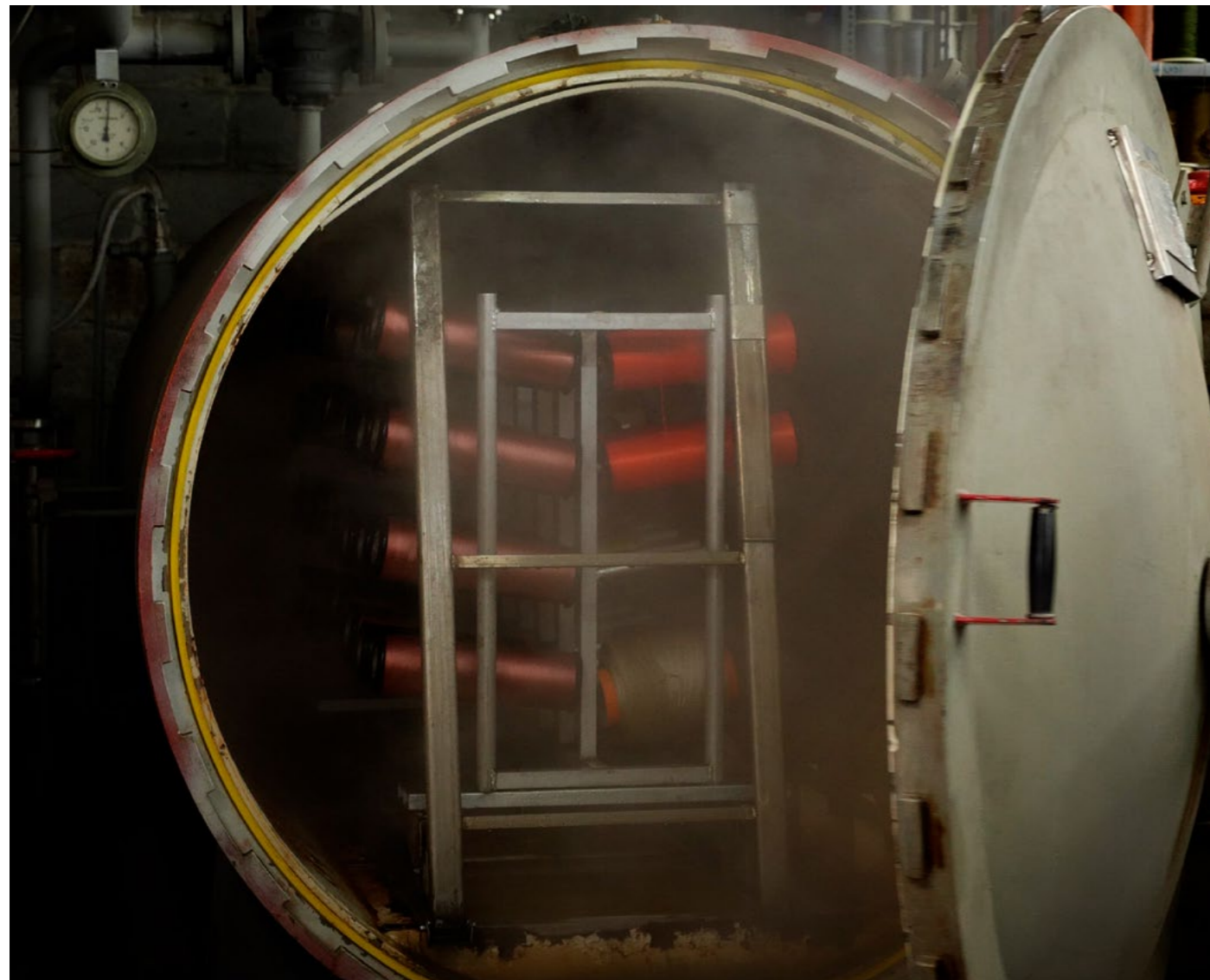

OUTDOOR CABLES

Outdoor EIVA cables

Our outdoor cables are also compatible with the EIVA system - Creative-Cables' water and rainproof outdoor lighting system.

Specifications:

H05RN-F 300/500Vac 2x1mm²
 Rubber sheathed flexible round IMQ-HAR Cable DOUBLE INSULATION under textile braid.
 Standard reference: EN 50525-2-11, Low Voltage European Directive No. 2014/35/EU, Products meeting the safety objectives of Low Voltage Directive 2014/35/EU (Annex I). IMQ-HAR certificate No. CA01.00683, DoP No. 0015.
 Diameter: 6,8mm 2x0,75mm² or 7,8mm 3x0,75mm².
 The cable is sold by the meter, multiple orders will be delivered in one piece up to a maximum of 50 meters in length.

MADE IN ITALY

IEMMEQU <HAR>
N° CA01.00683, DoP N° 0015

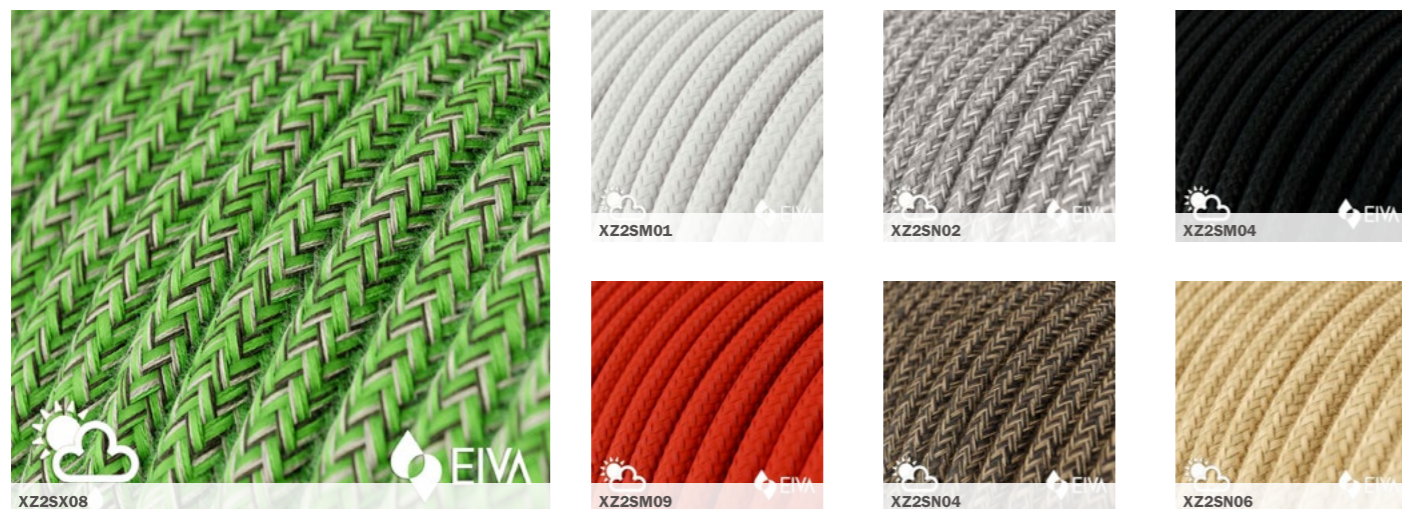

LARGE SECTION CABLES

Our large section (3x1,50mm²) cables will help you when you require some extra power: multi sockets, power leads, wall installations, extension cables. Choose among the offered styles (round, twisted) for what best serves your purpose: they are incredibly flexible, because we use high quality PVC to avoid bulges or wrinkles. All of our large section cables are IMQ-HAR certified, the highest quality standard in Europe. Every single product is designed and Made in Italy.

Large round silk-effect cables

Silk-effect cables have a bright solid finish, which is elegant yet informal. Shiny as silk, they can bring colour wherever needed.

Specifications:

H05VV-F 300/500Vac 3x1,50mm²
 Flex Round IMQ-HAR Cable DOUBLE INSULATION under textile braid.
 Standard reference: EN 50525-2-51, IMQ-HAR approval No. A0644, DoP No. 0019.
 Diameter: 8,5mm.
 The cable is sold by the meter, multiple orders will be delivered in one piece up to a maximum of 50 meters in length.

MADE IN ITALY

IEMMEQU <HAR>
N° A0644, DoP N° 0019

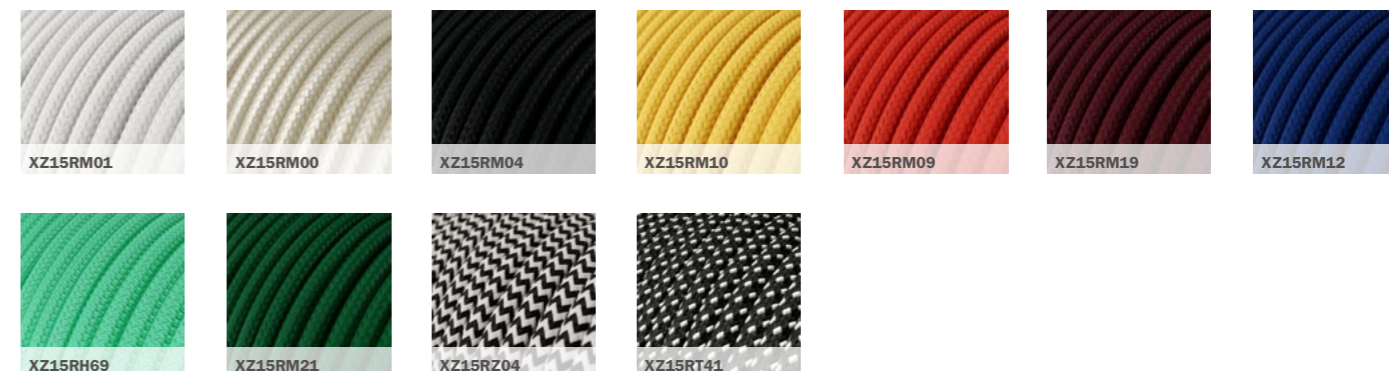
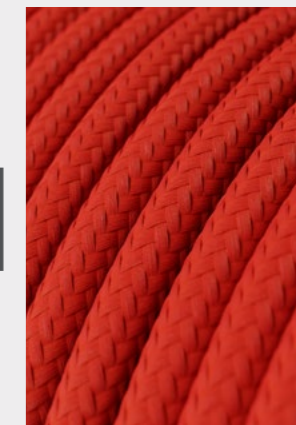

Large round natural fabric cables

Cotton cables have pastel colours and warm tones. Cotton has a natural look and matches cozy and minimal environments. Ideal for those who prefer a "raw" feeling.

Specifications:

H05VV-F 300/500Vac 3x1,50mm²
 Flex Round IMQ-HAR Cable DOUBLE INSULATION under textile braid.
 Standard reference: EN 50525-2-51, IMQ-HAR approval No. A0644, DoP No. 0019.
 Diameter: 8,5mm.
 The cable is sold by the meter, multiple orders will be delivered in one piece up to a maximum of 50 meters in length.

MADE IN ITALY

IEMMEQU <HAR>
N° A0644, DoP N° 0019

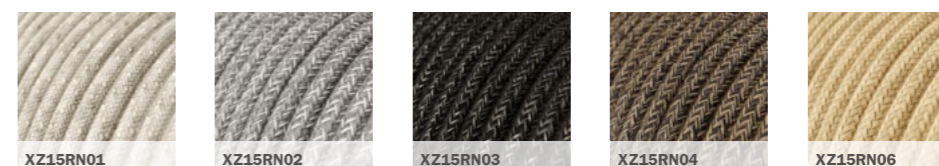

Large twisted silk-effect cables

Thanks to their special twisted texture, they look like braids: but believe us, they are real electric cables! Silk-effect cables have a bright solid finish, which is elegant yet informal.

Specifications:

FRRTX 300/300V_{ac} 3x1mm²
 Flex Twisted Visible Spiral Cable DOUBLE INSULATION (additional transparent sheath), braided woven cloth textile sleeve.
 Standard reference: Low Voltage European Directive No. 2014/35/EU.
 Diameter: 9mm.
 The cable is sold by the meter, multiple orders will be delivered in one piece up to a maximum of 50 meters in length.

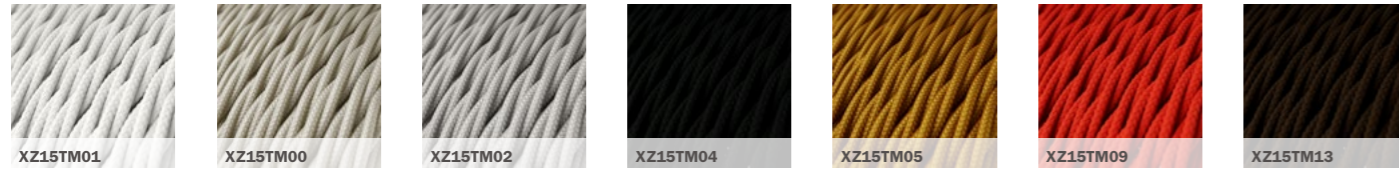

Large twisted natural cables

Thanks to their special twisted texture, they look like braids: but believe us, they are real electric cables! Linen and Jute have a natural feeling which will bring warmth and coziness to any room.

Specifications:

FRRTX 300/300V_{ac} 3x1mm²
 Flex Twisted Visible Spiral Cable DOUBLE INSULATION (additional transparent sheath), braided woven cloth textile sleeve.
 Standard reference: Low Voltage European Directive No. 2014/35/EU.
 Diameter: 9mm.
 The cable is sold by the meter, multiple orders will be delivered in one piece up to a maximum of 50 meters in length.
MADE IN ITALY

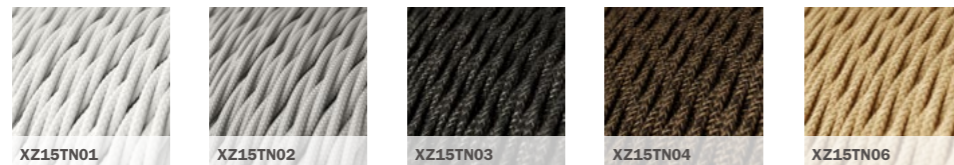

ROPE CABLES

Covered with soft flock and raw jute in order to increase their diameters, cables can become a nautical rope with various thicknesses, colours and finishes. Inspired by the maritime style, they can create a totally unexpected suspension lamp. Every single product is designed and Made in Italy.

Rope cables

The electrical cable becomes an electrical cord. The double covered electrical cables are covered with soft flocked and raw jute in order to reach a 16mm diameter. You can use XL electrical cord covered in raw jute to match our new natural wood roses and lamp holders in order to create suspension lamps of great effect.

Specifications:

FRRTX 300/300V_{ac} 3x0,75mm²
 Visible Spiral Flexible Cable which is double insulated, under the fabric braid.
 Standard reference: Low Voltage European Directive No. 2014/35/EU
 Diameter 16, 24 or 30mm.
 The cable is sold by the meter, multiple orders will be delivered in one piece up to a maximum of 20 meters in length.
MADE IN ITALY



XL - 16mm

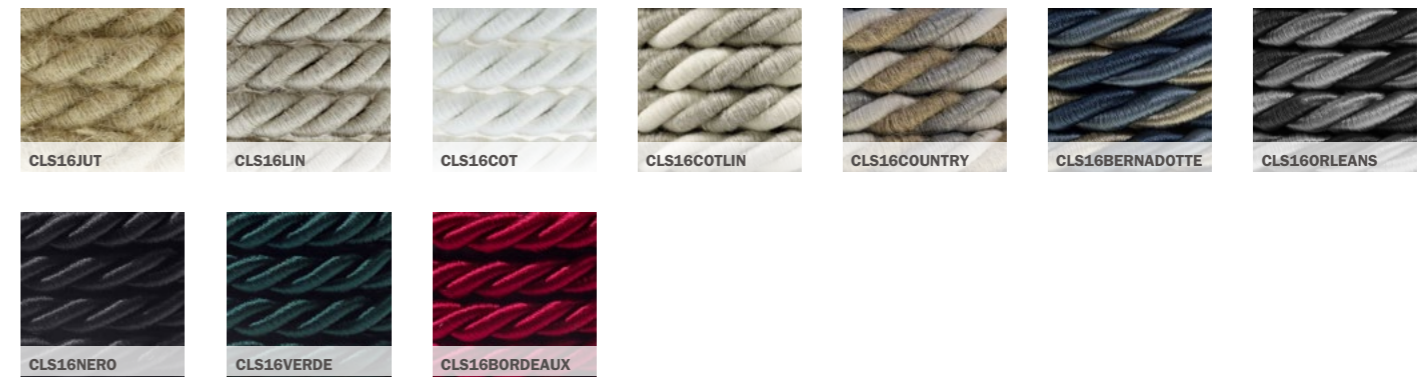

2XL - 24mm

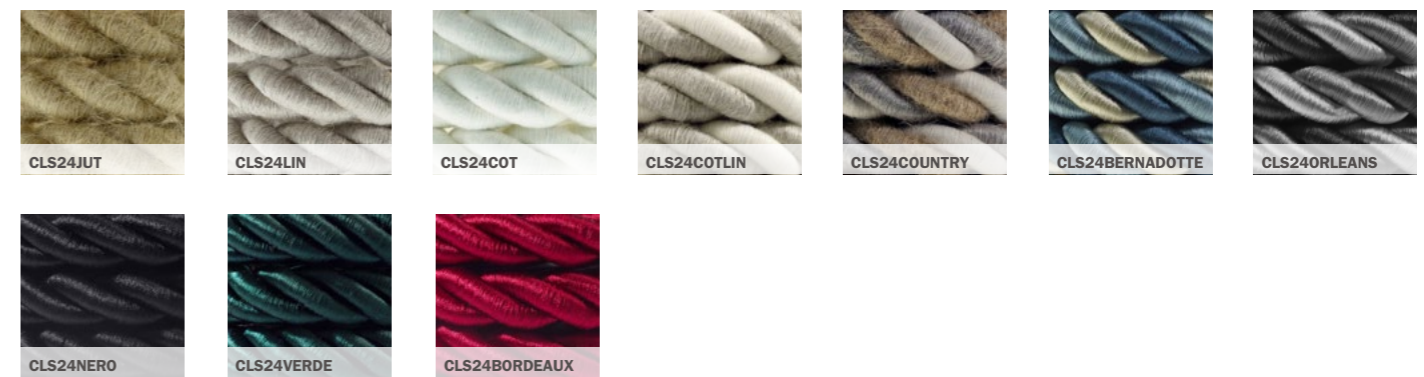

3XL - 30mm



Jute rope cable

This 2XL jute rope cable is featured by a double coating: the round electric cable covered in RN06 jute is enriched by the external coating of the braided jute cord thus reaching a 24mm external diameter. The round cable covered in 2x0.75 RN06 Jute runs inside the cord cover: in this way you can treat the cord like any other cable, without worrying about how to connect it.

Specifications:

H03VV-F 300/300V_{AC} 2x0,75mm²
 Flex Round IMQ-HAR Cable DOUBLE INSULATION under textile braid.
 Standard reference: EN 50525-2-11, Low Voltage European Directive No. 2014/35/EU, IMQ-HAR approval No. A0643, DoP No. 0008.
 Cable diameter: 6,2mm 2x0,75mm²
 Cover cable diameter: 24mm
 The cable is sold by the meter, multiple orders will be delivered in one piece up to a maximum of 20 meters in length.
MADE IN ITALY

IEMMEQU <HAR>
 N° A0643, DoP N° 0008

2XL - 24mm

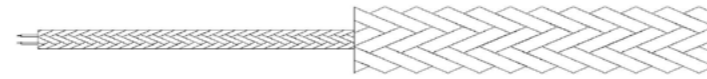
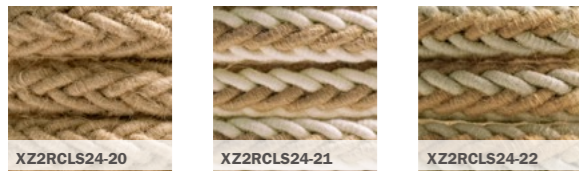

FLAT CABLES

Flat cables are Creative-Cables solution allowing you to both create wonderful string-light for your garden parties and beautiful indoor designs through the Filé System. Choose from a selection of trendy colors and add the necessary accessories for your compositions.

Flat cables

Specifications:

H05RNH2-F 300/500 V_{AC} Rectangular flat shaped 2x1,5mm² cable
 Standard reference: EN 50525-2-82 and IEC 60245.
 The cable is sold by the meter, multiple orders will be delivered in one piece up to a maximum of 25 meters in length.

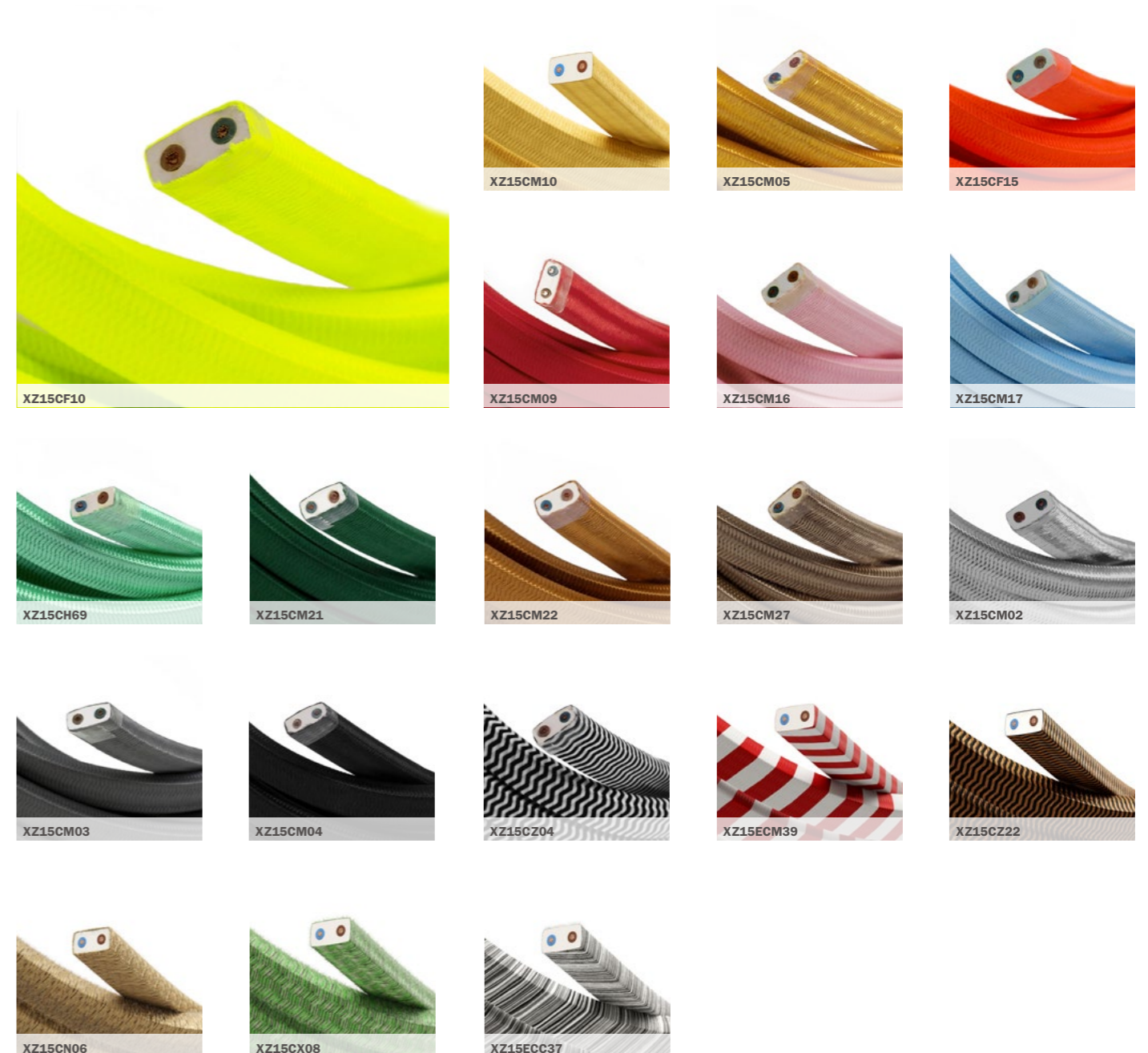



CEILING ROSES

COMPONENTS - CEILING ROSES

A ceiling rose is an essential accessory for any design lamp. We offer a wide range of shapes, sizes and materials that will easily match any home style.

Metal ceiling roses

Among our best selling products, metal ceiling roses are available in 6 finishes. We also created the 2-3-4-5-7 hole versions to create multiple pendants: the side-holes roses can help design a totally customized wall or ceiling light fitting array.

Cable clamps can be made from plastic or metal and have different lengths, for an even more personalised solutions.

Glossy white



ø 120mm H 25mm

Available with 2 kinds of cable clamps

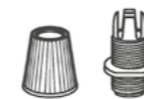

PC1SER01



SERP1BI

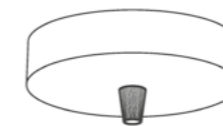

KRM57FCVB
1 hole ø 120mm H 25mm

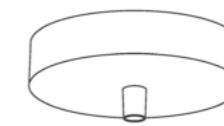

KRM57FCVBTERP
1 hole ø 120mm H 25mm

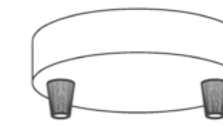

KRM572FVB
2 hole ø 120mm H 25mm

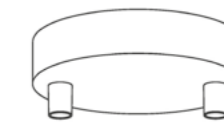

KRM572FVBTERP
2 hole ø 120mm H 25mm

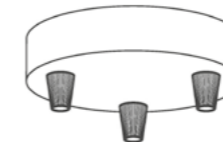

KRM573FVB
3 hole ø 120mm H 25mm

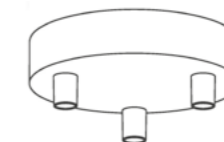

KRM573FVBTERP
3 hole ø 120mm H 25mm

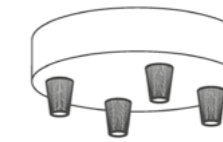

KRM574FVB
4 hole ø 120mm H 25mm

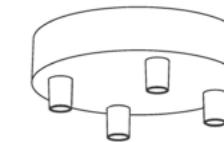

KRM574FVBTERP
4 hole ø 120mm H 25mm

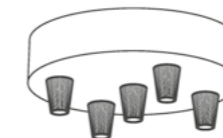

KRM575FVB
5 hole ø 120mm H 25mm

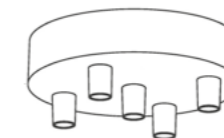

KRM575FVBTERP
5 hole ø 120mm H 25mm

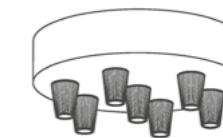

KRM576FVB
7 hole ø 120mm H 25mm

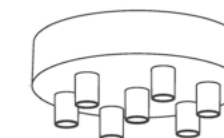

KRM576FVBTERP
7 hole ø 120mm H 25mm

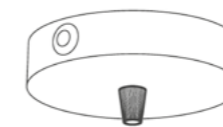

KRM12FC2LVB
1 hole + 2-side holes ø 120mm
H 25mm

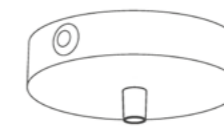

KRM12FC2LVBTERP
1 hole + 2-side holes ø 120mm
H 25mm

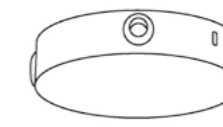

KRM12SF4LVB
4-side holes ø 120mm
H 25mm

Matte white



Ø 120mm H 25mm



Ø 83mm, H 25mm



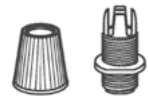



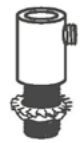



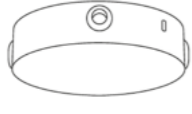
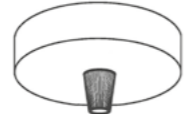
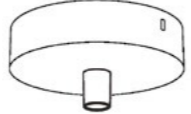

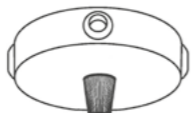
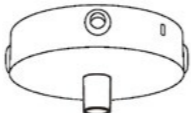

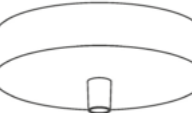



Available with 2 kinds of cable clamps



PC1SER01

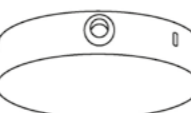

SERM1VB

 KRM83SF4LVBO 4-side holes Ø 83mm H 25mm	 KRM83FCVBO 1 hole Ø 83mm H 25mm	 KRM83FCVBOTERM 1 hole Ø 83mm H 25mm	 KRM83FC2LVBO 1 hole + 2-side holes Ø 83mm H 25mm
 KRM83FC2LVBOTERM 1 hole + 2-side holes Ø 83mm H 25mm	 KRM831F4LVBO 1 hole + 4-side holes Ø 83mm H 25mm	 KRM831F4LVBOTERM 1 hole + 4-side holes Ø 83mm H 25mm	 KRM57FCVBO 1 hole Ø 120mm H 25mm
 KRM57FCVBOTERM 1 hole Ø 120mm H 25mm	 KRM572FVBO 2 hole Ø 120mm H 25mm	 KRM572FVBOTERM 2 hole Ø 120mm H 25mm	 KRM573FVBO 3 hole Ø 120mm H 25mm
 KRM573FVBOTERM 3 hole Ø 120mm h 25mm	 KRM574FVBO 4 hole Ø 120mm H 25mm	 KRM574FVBOTERM 4 hole Ø 120mm H 25mm	 KRM575FVBO 5 hole Ø 120mm H 25mm
 KRM575FVBOTERM 5 hole Ø 120mm H 25mm	 KRM576FVBO 7 hole Ø 120mm H 25mm	 KRM576FVBOTERM 7 hole Ø 120mm H 25mm	 KRM12FC2LVBO 1 hole + 2-side holes Ø 120mm H 25mm
 KRM12FC2LVBOTERM 1 hole + 2-side holes Ø 120mm H 25mm	 KRM12SF4LVBO 4-side holes Ø 120mm H 25mm	 KRM57FCVBOTERM4 1 hole with 70mm cable clamp 120mm H 25mm	 KRM57FCVBOTERM5 1 hole with 150mm cable clamp 120mm H 25mm

Black



Ø 120mm H 25mm



Ø 83mm, H 25mm



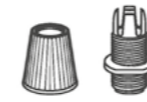







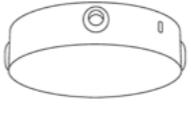



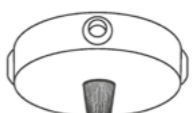
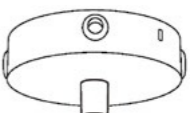

Available with 2 kinds of cable clamps

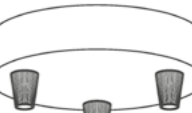
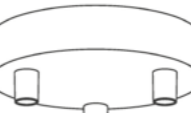

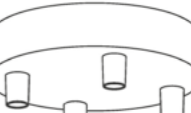
PC1SER02

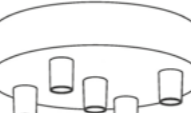
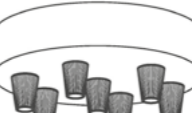
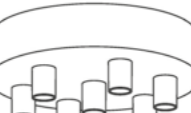
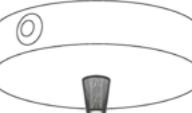

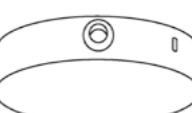
SERP1NE

 KRM83SF4LVN 4-side holes Ø 83mm H 25mm	 KRM83FCVN 1 hole Ø 83mm H 25mm	 KRM83FCVNTERM 1 hole Ø 83mm H 25mm	 KRM83FC2LVN 1 hole + 2-side holes Ø 83mm H 25mm
 KRM83FC2LVNTERM 1 hole + 2-side holes Ø 83mm H 25mm	 KRM831F4LVN 1 hole + 4-side holes Ø 83mm H 25mm	 KRM831F4LVNTERM 1 hole + 4-side holes Ø 83mm H 25mm	 KRM57FCVN 1 hole Ø 120mm H 25mm
 KRM57FCVNTERM 1 hole Ø 120mm H 25mm	 KRM572FVN 2 hole Ø 120mm H 25mm	 KRM572FVNTERM 2 hole Ø 120mm H 25mm	 KRM573FVN 3 hole Ø 120mm H 25mm
 KRM573FVNTERM 3 hole Ø 120mm H 25mm	 KRM574FVN 4 hole Ø 120mm H 25mm	 KRM574FVNTERM 4 hole Ø 120mm H 25mm	 KRM575FVN 5 hole Ø 120mm H 25mm
 KRM575FVNTERM 5 hole Ø 120mm H 25mm	 KRM576FVN 7 hole Ø 120mm H 25mm	 KRM576FVNTERM 7 hole Ø 120mm H 25mm	 KRM12FC2LVN 1 hole + 2-side holes Ø 120mm H 25mm
 KRM12FC2LVNTERM 1 hole + 2-side holes Ø 120mm H 25mm	 KRM12SF4LVN 4-side holes Ø 120mm H 25mm	 KRM57FCVNTERM4 1 hole with 70mm cable clamp 120mm H 25mm	 KRM57FCVNTERM5 1 hole with 150mm cable clamp 120mm H 25mm

Chrome



ø 120mm H 25mm

Available with 2 kinds of cable clamps

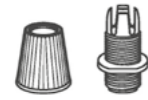

PC1SER00

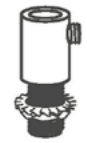

SERM1CR

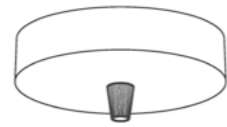

KRM57FCR
1 hole ø 120mm H 25mm

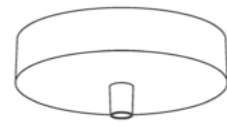

KRM57FCRTERM
1 hole ø 120mm H 25mm



KRM572FCR
2 hole ø 120mm H 25mm

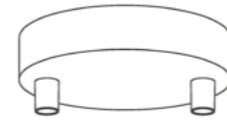

KRM572FCRTERM
2 hole ø 120mm H 25mm

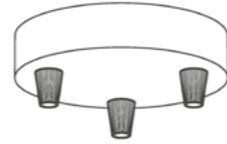

KRM573FCR
3 hole ø 120mm H 25mm

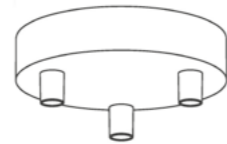

KRM573FCRTERM
3 hole ø 120mm H 25mm

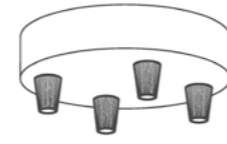

KRM574FCR
4 hole ø 120mm H 25mm

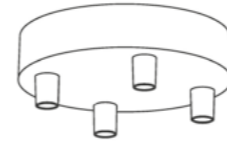

KRM574FCRTERM
4 hole ø 120mm H 25mm

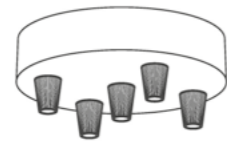

KRM575FCR
5 hole ø 120mm H 25mm

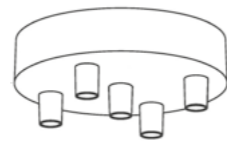

KRM575FCRTERM
5 hole ø 120mm H 25mm

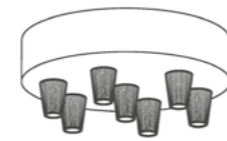

KRM576FCR
7 hole ø 120mm H 25mm

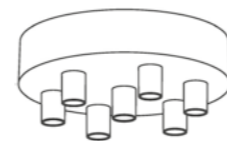

KRM576FCRTERM
7 hole ø 120mm H 25mm

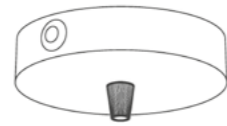

KRM12FC2LCR
1 hole + 2-side holes ø 120mm
H 25mm

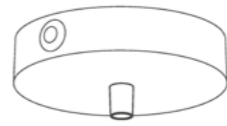

KRM12FC2LCRTERM
1 hole + 2-side holes ø 120mm
H 25mm

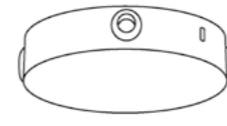

KRM12SF4LCR
4-side holes ø 120mm
H 25mm



KRM57FCRTERM4
1 hole with 70mm cable clamp
120mm H 25mm

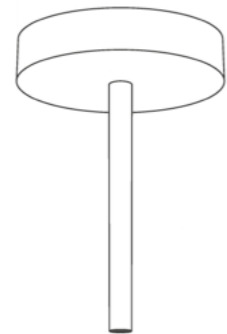

KRM57FCRTERM5
1 hole with 150mm cable clamp
120mm H 25mm

Copper



ø 120mm H 25mm

Available with 2 kinds of cable clamps

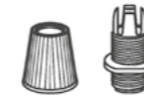

PC1SER00



SERM1RA

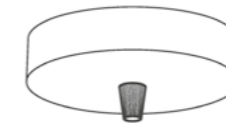

KRM57FCRA
1 hole ø 120mm H 25mm

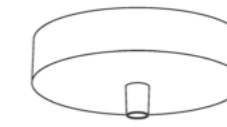

KRM57FCRATERM
1 hole ø 120mm H 25mm

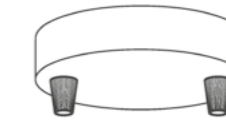

KRM572FRA
2 hole ø 120mm H 25mm

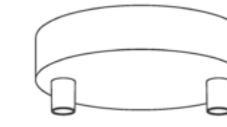

KRM572FRATERM
2 hole ø 120mm H 25mm

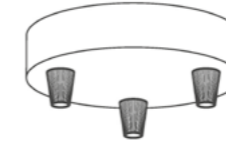

KRM573FRA
3 hole ø 120mm H 25mm

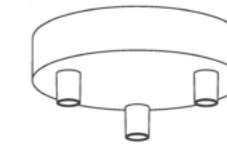

KRM573FRATERM
3 hole ø 120mm H 25mm

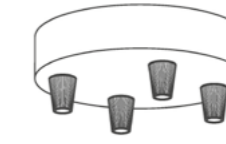

KRM574FRA
4 hole ø 120mm H 25mm

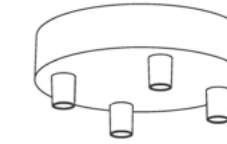

KRM574FRATERM
4 hole ø 120mm H 25mm

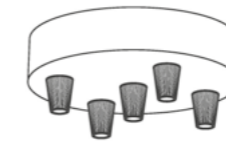

KRM575FRA
5 hole ø 120mm H 25mm

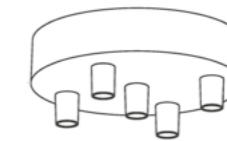

KRM575FRATERM
5 hole ø 120mm H 25mm

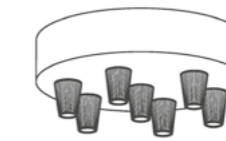

KRM576FRA
7 hole ø 120mm H 25mm

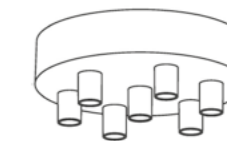

KRM576FRATERM
7 hole ø 120mm H 25mm

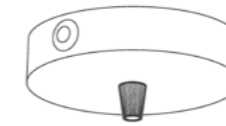

KRM12FC2LRA
1 hole + 2-side holes ø 120mm
H 25mm

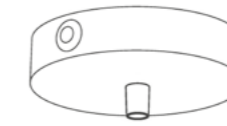

KRM12FC2LATERM
1 hole + 2-side holes ø 120mm
H 25mm

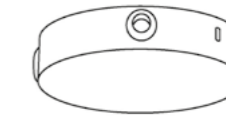

KRM12SF4LRA
4-side holes ø 120mm
H 25mm



KRM57FCRATERM4
1 hole with 70mm cable clamp
120mm H 25mm

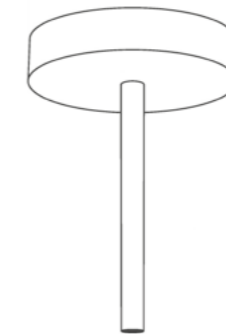

KRM57FCRATERM5
1 hole with 150mm cable clamp
120mm H 25mm

Brass



ø 120mm H 25mm

Available with 2 kinds of cable clamps

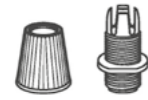

PC1SER00

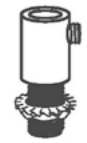

SERM1G0

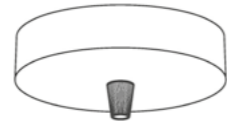

KRM57FCGO
1 hole ø 120mm H 25mm

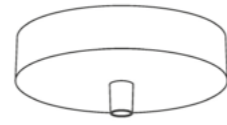

KRM57FCGOTERM
1 hole ø 120mm H 25mm



KRM572FGO
2 hole ø 120mm H 25mm

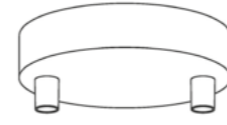

KRM572FGOTERM
2 hole ø 120mm H 25mm

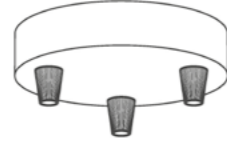

KRM573FGO
3 hole ø 120mm H 25mm

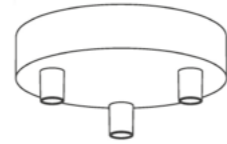

KRM573FGOTERM
3 hole ø 120mm H 25mm

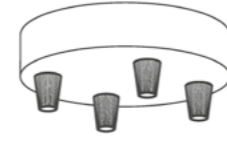

KRM574FGO
4 hole ø 120mm H 25mm

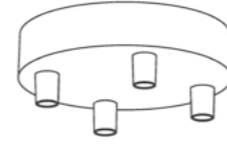

KRM574FGOTERM
4 hole ø 120mm H 25mm

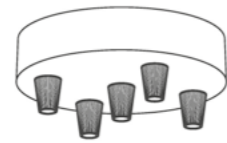

KRM575FGO
5 hole ø 120mm H 25mm

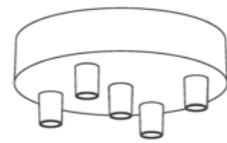

KRM575FGOTERM
5 hole ø 120mm H 25mm

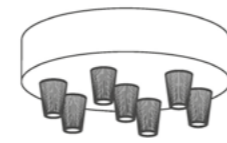

KRM576FGO
7 hole ø 120mm H 25mm

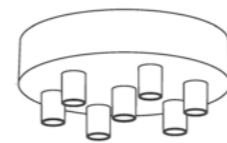

KRM576FGOTERM
7 hole ø 120mm H 25mm

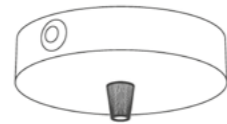

KRM12FC2LGO
1 hole + 2-side holes ø 120mm
H 25mm

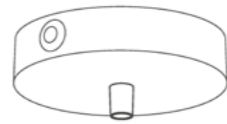

KRM12FC2LGOTERM
1 hole + 2-side holes ø 120mm
H 25mm

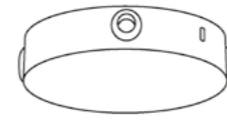

KRM12SF4LGO
4-side holes ø 120mm
H 25mm



KRM57FCGOTERM4
1 hole with 70mm cable clamp
120mm H 25mm

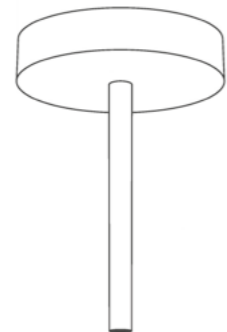

KRM57FCGOTERM5
1 hole with 150mm cable clamp
120mm H 25mm

Pearl black



ø 120mm H 25mm

Available with 2 kinds of cable clamps

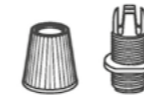

PC1SER02



SERM1BR

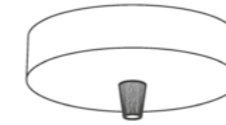

KRM57FCBR
1 hole ø 120mm H 25mm

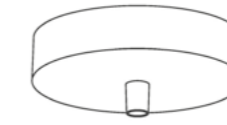

KRM57FCBRTERM
1 hole ø 120mm H 25mm

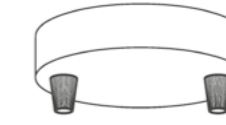

KRM572FBR
2 hole ø 120mm H 25mm

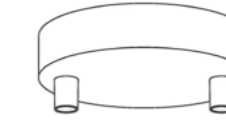

KRM572FBRTERM
2 hole ø 120mm H 25mm

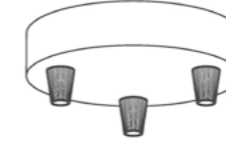

KRM573FBR
3 hole ø 120mm H 25mm

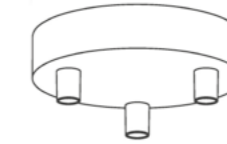

KRM573FBRTERM
3 hole ø 120mm H 25mm

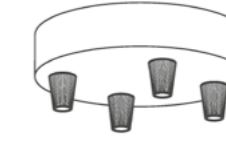

KRM574FBR
4 hole ø 120mm H 25mm

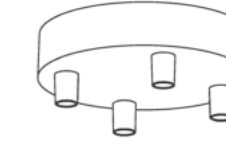

KRM574FBRTERM
4 hole ø 120mm H 25mm

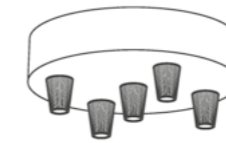

KRM575FBR
5 hole ø 120mm H 25mm

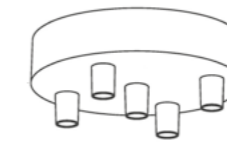

KRM575FBRTERM
5 hole ø 120mm H 25mm

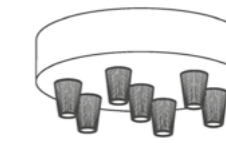

KRM576FBR
7 hole ø 120mm H 25mm

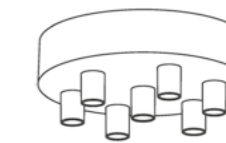

KRM576FBRTERM
7 hole ø 120mm H 25mm

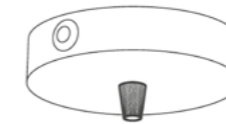

KRM12FC2LBR
1 hole + 2-side holes ø 120mm
H 25mm

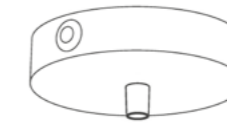

KRM12FC2LBRTERM
1 hole + 2-side holes ø 120mm
H 25mm

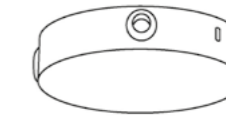

KRM12SF4LBR
4-side holes ø 120mm
H 25mm



KRM57FCBRTERM4
1 hole with 70mm cable clamp
120mm H 25mm

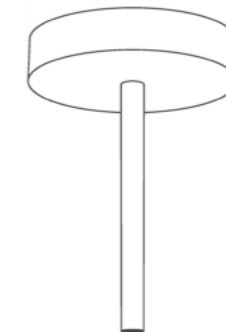

KRM57FCBRTERM5
1 hole with 150mm cable clamp
120mm H 25mm

Brushed titanium



ø 120mm H 25mm



ø 83mm, H 25mm

Available with 2 kinds of cable clamps



PC1SER02

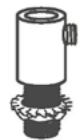

SERM1TIS

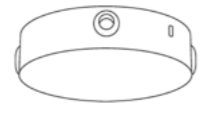

KRM83SF4LTIS
4-side holes ø 83mm H 25mm



KRM83FCTIS
1 hole ø 83mm H 25mm

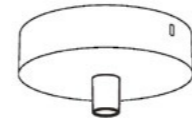

KRM83FCTISTERM
1 hole ø 83mm H 25mm



KRM83FC2LTIS
1 hole + 2-side holes ø 83mm
H 25mm

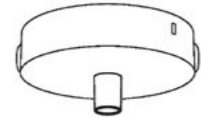

KRM83FC2LTISTERM
1 hole + 2-side holes ø 83mm
H 25mm

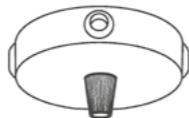

KRM831F4LTIS
1 hole + 4-side holes ø 83mm
H 25mm

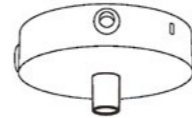

KRM831F4LTISTERM
1 hole + 4-side holes ø 83mm
H 25mm



KRM57FCTIS
1 hole ø 120mm H 25mm

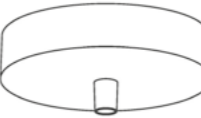

KRM57FCTISTERM
1 hole ø 120mm H 25mm

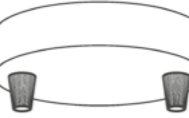

KRM572FTIS
2 hole ø 120mm H 25mm

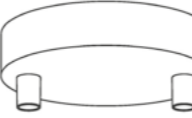

KRM572FTISTERM
2 hole ø 120mm H 25mm

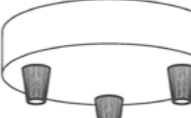

KRM573FTIS
3 hole ø 120mm H 25mm



KRM573FTISTERM
3 hole ø 120mm H 25mm



KRM574FTIS
4 hole ø 120mm H 25mm



KRM574FTISTERM
4 hole ø 120mm H 25mm



KRM575FTIS
5 hole ø 120mm H 25mm



KRM575FTISTERM
5 hole ø 120mm H 25mm



KRM576FTIS
7 hole ø 120mm H 25mm

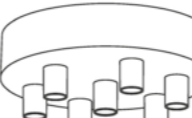

KRM576FTISTERM
7 hole ø 120mm H 25mm



KRM12FC2LTIS
1 hole + 2-side holes ø 120mm
H 25mm

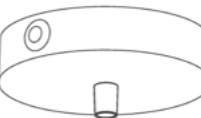

KRM12FC2LTISTERM
1 hole + 2-side holes ø 120mm
H 25mm

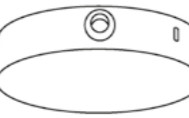

KRM12SF4LTIS
4-side holes ø 120mm
H 25mm



KRM57FCTISTERM4
1 hole with 70mm cable clamp
120mm H 25mm



KRM57FCTISTERM5
1 hole with 150mm cable clamp
120mm H 25mm

Brushed bronze



ø 120mm H 25mm



ø 83mm, H 25mm

Available with 2 kinds of cable clamps

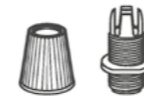

PC1SER00



SERM10TS

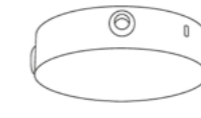

KRM83SF4LOTS
4-side holes ø 83mm H 25mm



KRM83FCOTS
1 hole ø 83mm H 25mm

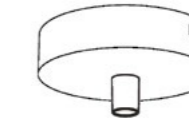

KRM83FCOTSTERM
1 hole ø 83mm H 25mm



KRM83FC2LOTS
1 hole + 2-side holes ø 83mm
H 25mm

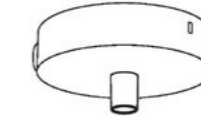

KRM83FC2LOTSTERM
1 hole + 2-side holes ø 83mm
H 25mm



KRM831F4LOTS
1 hole + 4-side holes ø 83mm
H 25mm

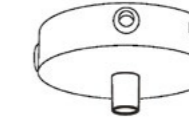

KRM831F4LOTSTERM
1 hole + 4-side holes ø 83mm
H 25mm



KRM57FCOTS
1 hole ø 120mm H 25mm



KRM57FCOTSTERM
1 hole ø 120mm H 25mm



KRM572FOTS
2 hole ø 120mm H 25mm

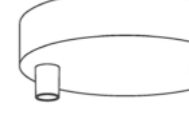

KRM572FOTSTERM
2 hole ø 120mm H 25mm



KRM573FOTS
3 hole ø 120mm H 25mm



KRM573FOTSTERM
3 hole ø 120mm H 25mm



KRM574FOTS
4 hole ø 120mm H 25mm



KRM574FOTSTERM
4 hole ø 120mm H 25mm



KRM575FOTS
5 hole ø 120mm H 25mm



KRM575FOTSTERM
5 hole ø 120mm H 25mm

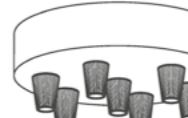

KRM576FOTS
7 hole ø 120mm H 25mm



KRM576FOTSTERM
7 hole ø 120mm H 25mm



KRM12FC2LOTS
1 hole + 2-side holes ø 120mm
H 25mm

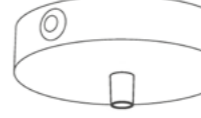

KRM12FC2LOTSTERM
1 hole + 2-side holes ø 120mm
H 25mm



KRM12SF4LOTS
4-side holes ø 120mm
H 25mm



KRM57FCOTSTERM4
1 hole with 70mm cable clamp
120mm H 25mm



KRM57FCOTSTERM5
1 hole with 150mm cable clamp
120mm H 25mm

Brushed copper

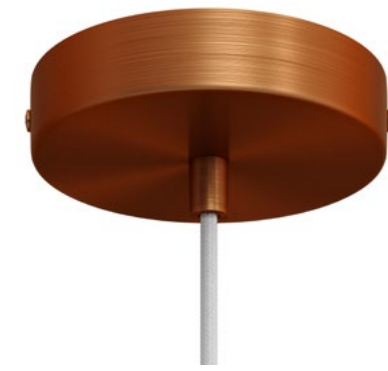

Ø 120mm, H 25mm



Ø 83mm, H 25mm

Available with 2 kinds of cable clamps

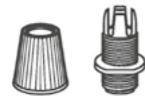

PC1SER00

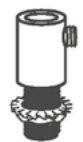

SERM1RAS

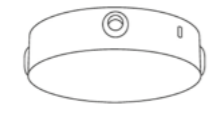

KRM83SF4LRAS
4-side holes Ø 83mm H 25mm



KRM83FCRAS
1 hole Ø 83mm H 25mm

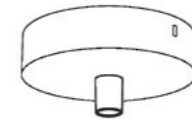

KRM83FCRASTERM
1 hole Ø 83mm H 25mm



KRM83FC2LRAS
1 hole + 2-side holes Ø 83mm H 25mm

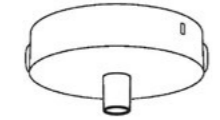

KRM83FC2LRASTERM
1 hole + 2-side holes Ø 83mm H 25mm

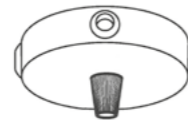

KRM831F4LRAS
1 hole + 4-side holes Ø 83mm H 25mm

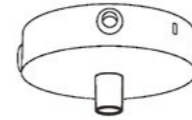

KRM831F4LRASTERM
1 hole + 4-side holes Ø 83mm H 25mm



KRM57FCRAS
1 hole Ø 120mm H 25mm



KRM57FCRASTERM
1 hole Ø 120mm H 25mm

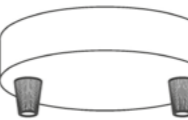

KRM572FRAS
2 hole Ø 120mm H 25mm

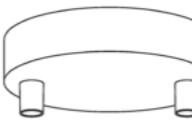

KRM572FRASTERM
2 hole Ø 120mm H 25mm

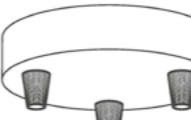

KRM573FRAS
3 hole Ø 120mm H 25mm

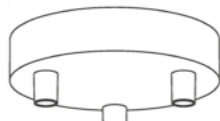

KRM573FRASTERM
3 hole Ø 120mm H 25mm

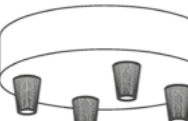

KRM574FRAS
4 hole Ø 120mm H 25mm

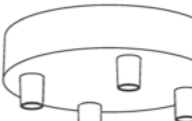

KRM574FRASTERM
4 hole Ø 120mm H 25mm

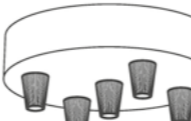

KRM575FRAS
5 hole Ø 120mm H 25mm



KRM575FRASTERM
5 hole Ø 120mm H 25mm



KRM576FRAS
7 hole Ø 120mm H 25mm

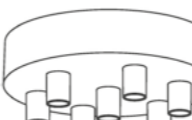

KRM576FRASTERM
7 hole Ø 120mm H 25mm

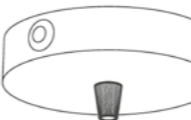

KRM12FC2LRAS
1 hole + 2-side holes Ø 120mm H 25mm

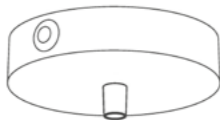

KRM12FC2LRASTERM
1 hole + 2-side holes Ø 120mm H 25mm

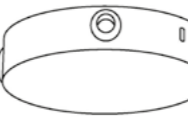

KRM12SF4LRAS
4-side holes Ø 120mm H 25mm



KRM57FCRASTERM4
1 hole with 70mm cable clamp 120mm H 25mm



KRM57FCRASTERM5
1 hole with 150mm cable clamp 120mm H 25mm

Painted dark rust



Ø 120mm, H 25mm

Available with 2 kinds of cable clamps



PC1SER00

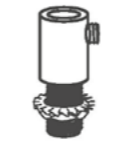

SERM1RU



KRM57FCRU
1 hole Ø 120mm H 25mm



KRM57FCRUTERM
1 hole Ø 120mm H 25mm

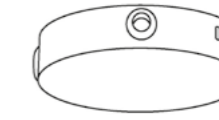

KRM12SF4LRU
4-side holes Ø 120mm H 25mm



KRM57FCRUTERM4
1 hole with 70mm cable clamp 120mm H 25mm

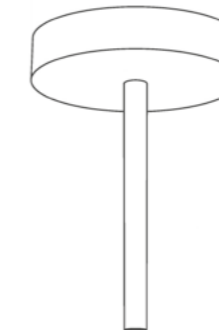

KRM57FCRUTERM5
1 hole with 150mm cable clamp 120mm H 25mm

Flush-mounted ceiling rose

This wall-mounted ceiling rose combines functionality and aesthetics: thanks to its reduced thickness, it provides a wonderful concealed effect that blends in harmoniously with the design of the room and is compatible with both masonry and plasterboard ceilings and walls.



1-side hole Ø 126mm H 7mm



KRM126FFCVB0



KRM126FFCVN

Metal painted ceiling rose



Ø 50mm, H 50mm



25902



25909



25900



25905

Italian woodworking craftsmanship,
natural simplicity that never goes out of style.



We produce our wooden components in a small workshop in the province of Turin, our hometown. Here, the distinctive Italian craftsmanship, care and creativity of our designers transforms every wood log into beautiful components to illuminate your spaces.

Wood ceiling roses

We first designed them for our rope cables and offered in three basic colours, but they are so extremely versatile that we've created more options to give you more possibilities to style your interior as you prefer: natural wood can be painted or polished as desired. Each ceiling rose has a matching wooden lamp holder.

120 cm diameter



- KRL0110
- KRL0210
- KRL0310
- KRL0410



- Compatible with XL rope cables (16mm)
- KRL0116
 - KRL0216
 - KRL0316



- Compatible with 2XL rope cables (24mm)
- KRL0124
 - KRL0224
 - KRL0324



- Compatible with 3XL rope cables (30mm)
- KRL0130
 - KRL0230
 - KRL0330



- KRL1110
- KRL1210
- KRL1310

120 cm diameter multi-hole



Ø 120mm, H 32mm

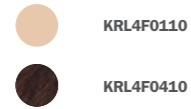

88 cm diameter



Ø 88mm, H 30mm

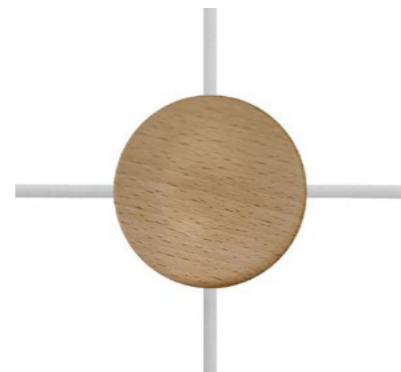
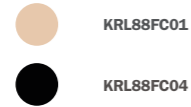

Ø 88mm, H 30mm

KRL88SF4L01



Ø 88mm, H 30mm

KRL88FC2L01

Leather-covered wooden ceiling roses

Add a touch of glamour and elegance with our leather covered wooden ceiling roses. The leather is handcrafted and sewn in Italy.



Ø 124mm, H 36mm

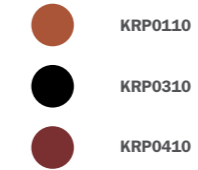

Silicone ceiling roses

Silicone ceiling roses are resistant, colourful and easy to install: you won't need to drill into your ceiling. Last but not least, they have a very attractive price! Each ceiling rose has a matching silicone lamp holder.



Ø 83mm, H 35mm



Hand painted ceramic ceiling roses

They are entirely manufactured in Italy: each item is unique and slight differences are due to the hand painting process.



Ceramic ceiling roses

These 7-hole rosettes are hand-made in Italy: each piece is unique! Due to their natural look, they are perfect for a country or shabby chic home. Each ceiling rose has a matching ceramic lamp holder.



Porcelain ceiling roses

Porcelain is a timeless classic and is an elegant solution that will make your wall or ceiling lamps absolutely unique. Each ceiling rose has a matching porcelain lamp holder.





Source: @sugahomedesign

LAMP HOLDERS

COMPONENTS - LAMP HOLDERS

A lamp holder is an essential accessory for any design lamp. We offer a wide range of shapes, sizes and materials that will easily match any living or working environment. Lamp Holders can match or contrast the ceiling roses: it's up to you! All our lamp holders are IMQ-ENEC certified, the highest quality standard in Europe.





LEGEND AND FINISHINGS







 Glossy white / Matte white	 Copper	 Brushed titanium	
 Black	 Brass	 Brushed copper	 Painted dark rust
 Chrome	 Black pearl	 Brushed bronze	

Metal lamp holders





Our best-selling lamp holders, offered in six different finishes and different styles: metal, vintage, milled metal and double-ferrule. These last can be used with lampshades too! Each lamp holder has a matching metal ceiling rose.









-  KBM4011VB0
-  KBM4011VB
-  KBM4011VN
-  KBM4011CR
-  KBM4011RA





-  KBM4011GO
-  KBM4011BR
-  KBM4011TIS
-  KBM4011RAS
-  KBM4011OTS
-  KBM4011RU







-  KBM4011VB0TERM
-  KBM4011VBTERP
-  KBM4011VNTERM
-  KBM4011CRTERM
-  KBM4011RATERM

-  KBM4011GOTERM
-  KBM4011BRTERM
-  KBM4011TISTERM
-  KBM4011RASTERM
-  KBM4011OTSTERM
-  KBM4011RUTERM



-  KBM4011VB0TERM4
-  KBM4011VNTERM4
-  KBM4011CRTERM4
-  KBM4011RATERM4
-  KBM4011GOTERM4

-  KBM4011BRTERM4
-  KBM4011TISTERM4
-  KBM4011RASTERM4
-  KBM4011OTSTERM4
-  KBM4011RUTERM4



- KBM4011VBOTERM5
 - KBM4011VNTERM5
 - KBM4011CRTERM5
 - KBM4011RATERM5
 - KBM4011GOTERM5
- KBM4011BRTERM5
 - KBM4011TISTERM5
 - KBM4011RASTERM5
 - KBM4011OTSTERM5
 - KBM4011RUTERM5



- KBL27ALBR
- KBL27ALCR
- KBL27ALRA
- KBL27ALGO



- KBR27ALCF
- KBR27ALRA
- KBR27ALGO



- KBM4551VB0
 - KBM4551VN
 - KBM4551TIS
 - KBM4551RAS
 - KBM4551OTS
- KBM4551PE
 - KBM4551VE
 - KBM4551SB
 - KBM4551RU



- KBM4367PE
- KBM4367VE
- KBM4367SB
- KBM4367MU



- PL14MARTF
- PL14MRATF
- PL14MOTTF

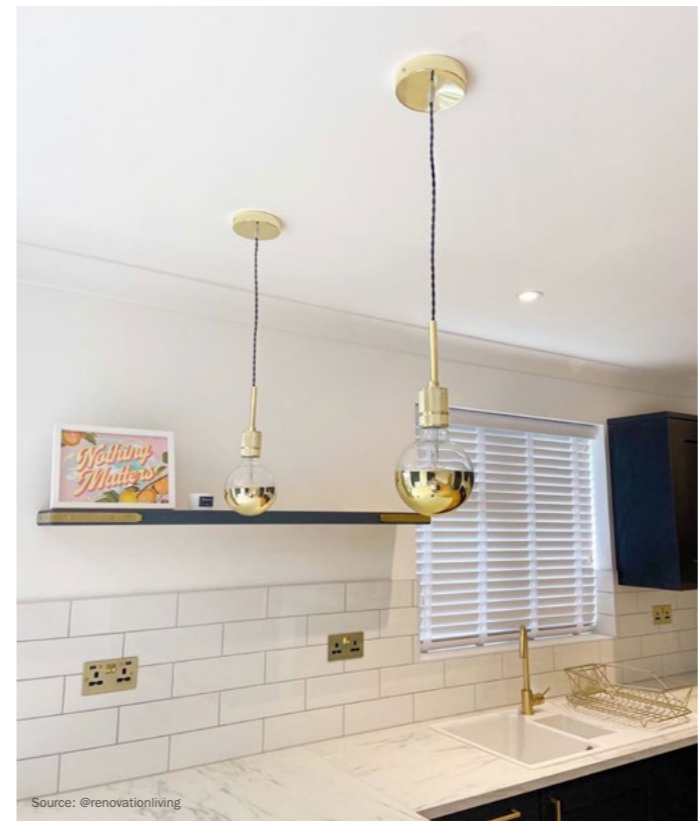

- PL14MARTFTERM
- PL14MRATFTERM
- PL14MOTTFTERM



- PL27MBRTF
- PL27MARTF
- PL27MRATF
- PL27MOTTF
- PL27MZVCFU
- PL27MZVRUG

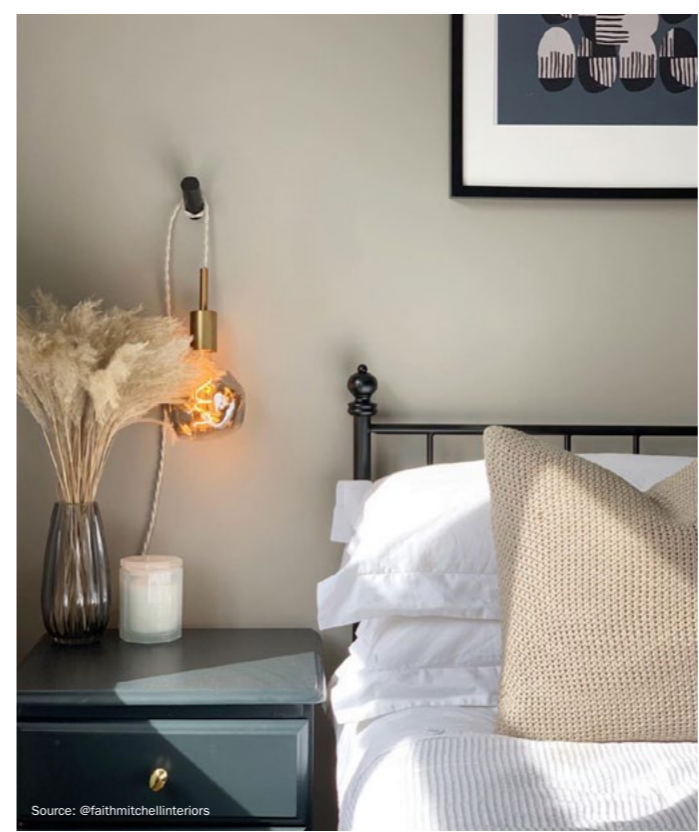

- 25927
- 25934
- 25925
- 25930



- PL27MBRTFTERM
- PL27MARTFTERM
- PL27MRATFTERM
- PL27MOTTFTERM

P-Light



P-Light is the unique E14 fitting lamp holder kit allowing you to create special lighting solutions with tubular light bulbs. You'll be able to create single or multiple pendant suspensions, perfect to illuminate rooms of different dimensions.

Combine up to 15 pendants by matching P-Light with our selection of decorated Rose-One System XXL ceiling roses or pair it with smaller roses to create the pendant lamp that best matches your interior.

From monochromatic shades up to brushed metal finishes, this little yet functional lamp holder kit is available in a variety of versions. This makes it suitable for different kinds of styles and interior design needs.



E14, Ø 29mm, H 98mm



-  KBME14VN
-  KBME14RA
-  KBME14GO
-  KBME14TIS
-  KBME14RAS
-  KBME14OTS

Thermoplastic E27 wall or ceiling lampholders

The lamp holder with E27 socket is the simple and functional solution to create a wall or ceiling light point that can offer complementary light and give a refined decorative note to any wall. Choose the finish that best matches your interiors. Thanks to the E27 socket, you can decide which bulb to match from our wide range of E27 decorative LED bulbs.



E27, Ø 83mm, H 58,2mm

-  PL27PBIE
-  PL27PNIE



E27, Ø 83mm, H 58,2mm

-  KPL27PCRDE
-  KPL27PRADE
-  KPL27PGODE



Thermoplastic and bakelite lamp holders

We recommend bakelite lamp holders to all fans of the vintage look and plastic if you need a neutral colour or just a simple design. Available with E14 or E27 fitting, also for lampshades if needed. Some versions include a switch or a pull cord switch. All products are sold individually or in bulk boxes (100, 500 or 1000 pieces).

Thermoplastic



E14, Ø 44mm, H 62mm



PL14PBLI

PL14PNLI



E14, Ø 40mm, H 55mm

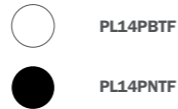

PL14PBTF

PL14PNTF



E27, Ø 39mm, H 54mm

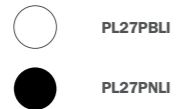

PL27PBLI

PL27PNLI



E27, Ø 40mm, H 54mm

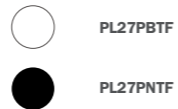

PL27PBTf

PL27PNTf



E27, Ø 39mm, H 77mm

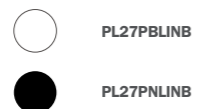

PL27PBLINB

PL27PNLINB



E27, Ø 39mm, H 76mm

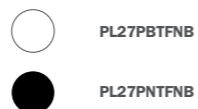

PL27PBTfNB

PL27PNTfNB



E27, Ø 38mm, H 67mm

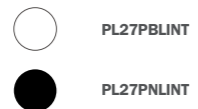

PL27PBLINT

PL27PNLINT



E27, Ø 40mm, H 67mm

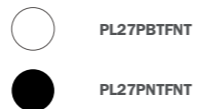

PL27PBTfNT

PL27PNTfNT

Bakelite



E14, Ø 27mm, H 55mm

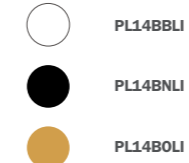

PL14BBLI

PL14BNLI

PL14BOLI



E14, Ø 28mm, H 55mm

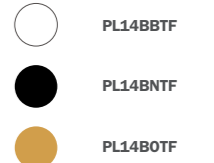

PL14BBTF

PL14BNTF

PL14BOTF



E27, Ø 40mm, H 54mm

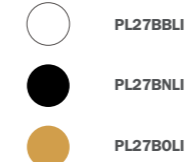

PL27BBLI

PL27BNLI

PL27BOLI



E27, Ø 40mm, H 54mm

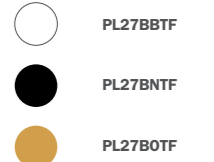

PL27BBTF

PL27BNTF

PL27BOTF



E27, Ø 40mm, H 79mm

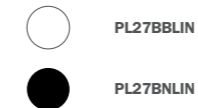

PL27BBLIN

PL27BNLIN



E27, Ø 40mm, H 79mm



PL27BBFIN

PL27BNFIN



E27, Ø 40mm, H 54mm

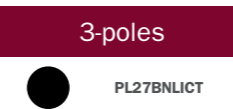

3-poles

PL27BNLICt

Silicone E27 lamp holders

Silicone lamp holders are resistant, colourful and easy to install. Last but not least, they have a very attractive price! Each lamp holder has a matching silicone ceiling rose.



E27, Ø 47mm, H 55mm

Leather covered E27 wooden lamp holders

Add a touch of glamour and elegance with our leather-covered wooden lampholders. The leather is handcrafted and sewn in Italy.

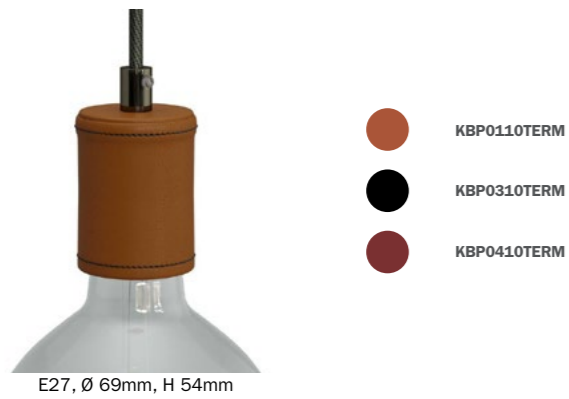

E27, Ø 69mm, H 54mm

Ceramic E27 lamp holders



E27, Ø 54mm, H 66mm

Wood E27 lamp holders

Specifically designed for our rope cables and offered in three basic colours, they are extremely versatile: natural wood can be painted or polished as desired. Each lamp holder has a matching wooden ceiling rose.

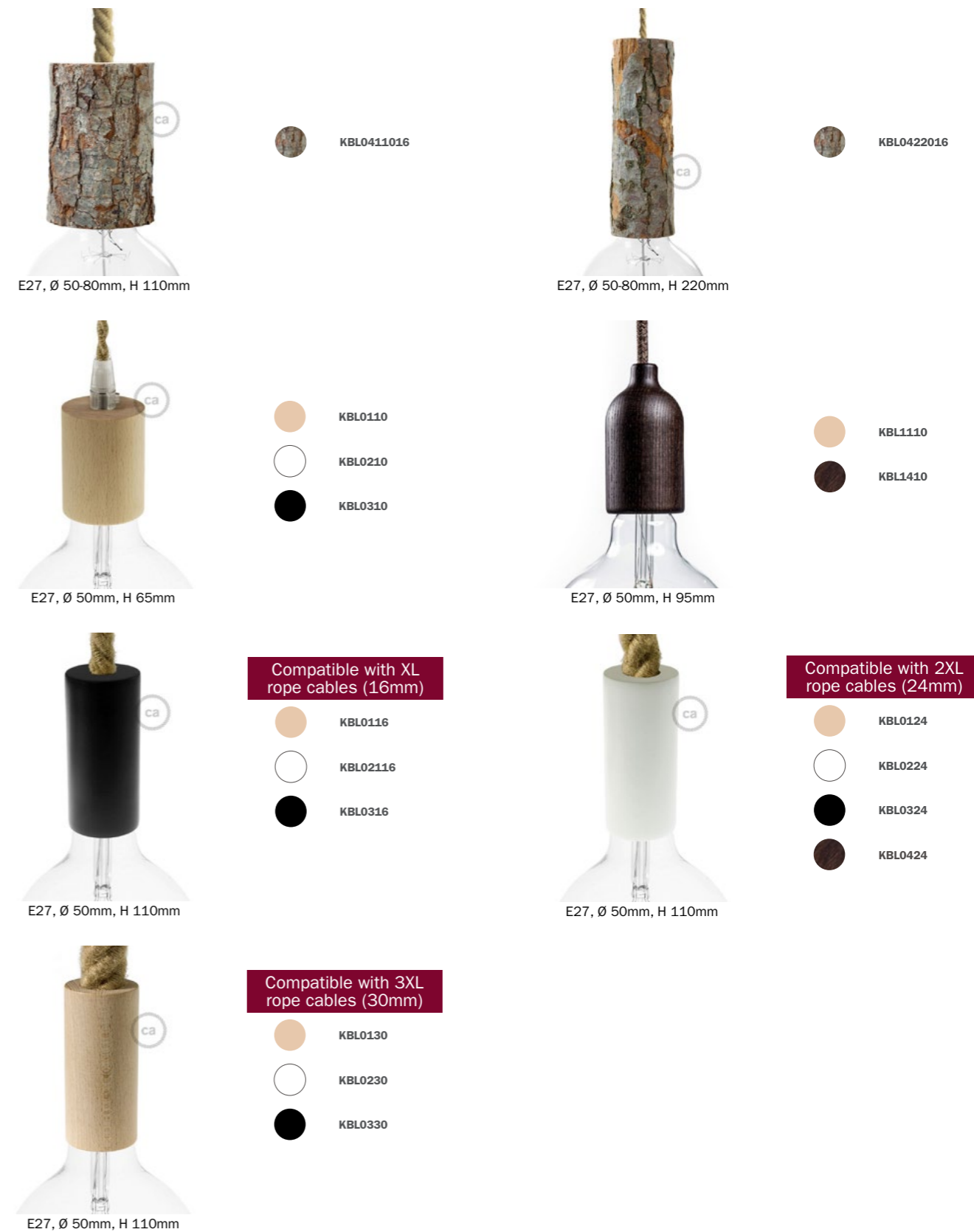

E27, Ø 50-80mm, H 110mm

E27, Ø 50-80mm, H 220mm

E27, Ø 50mm, H 65mm

E27, Ø 50mm, H 95mm

E27, Ø 50mm, H 110mm

E27, Ø 50mm, H 110mm

E27, Ø 50mm, H 110mm

Porcelain lamp holders

Porcelain is a timeless classic and is an elegant solution that will make your wall or ceiling lamps absolutely unique. Each lamp holder has a matching porcelain ceiling rose.



Cement E27 lamp holders

Concrete is a building material that has recently established itself as a real furnishing element inside houses and commercial activities and it's perfect to expose your favourite design light bulbs!

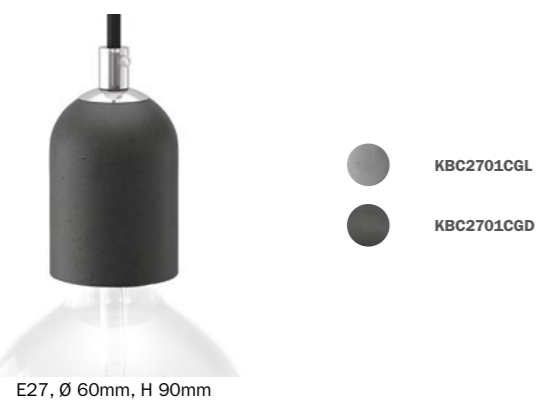

Source: @ourplacetobe



Source: Estaily London

COMPONENTS - SPOTLIGHTS





Illuminate any your corner needs a direct light with our spotlights LED.
Need suggestions? Your desk or reading corner or...any other space you'd like to light up!

Tub-E14

The Tub-E14 is the ideal lamp shade for anyone who enjoys using a spotlight. It provides a directed beam of light that creates an ambiance and is designed to fit an E14 double ring lamp holder. Tub-E14 is a multi-purpose lighting solution that works well as a shade for a single or multiple pendant lamps or wall lights.



E14, L 60mm, H 153mm

-  KSPOTME14VB0
-  KSPOTME14VN
-  KSPOTME14TIS
-  KSPOTME14RAS
-  KSPOTME140TS

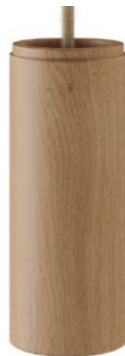

E14, L 60mm, H 150mm







-  KSPOTLE1401

Make it double!

Beauty doubles with the Tub-E14 double version.
The Tub-E14 shade has a minimalist design with a Scandinavian flair and is available in both metal and wood options with a pleasing contrast.







E14, L 60mm, H 306mm

-  K2SPOTME14VB0TIS
-  K2SPOTME14VB00TS
-  K2SPOTME14VB0RAS
-  K2SPOTME14VNTIS
-  K2SPOTME14VN0TS
-  K2SPOTME14VNRAS



E14, L 60mm, H 300mm

-  K2SPOTLME14VB001
-  K2SPOTLME14VN01
-  K2SPOTLME14TIS01
-  K2SPOTLME140TS01
-  K2SPOTLME14RAS01



 SPOTLIGHTS

GU1d0

Written GU1d0 but pronounced GU1dO, it is a mini spotlight for directional LED light that allows you to illuminate with an approximately 260-lumen directional beam light the bedside table when reading, your child's homework (when he eventually decides to do it), in short, any point where you need a direct and circumscribed beam of light (of about 36°).



Mini GU10, L 44mm, H 76mm

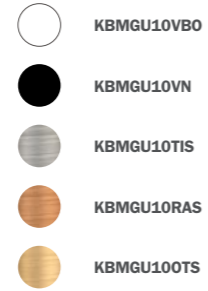

MINI GU10

GU1d0 is fitted with a MINI GU10 (or MR11) bulb, smaller than the normal GU10 bulb because of its 35 mm diameter and 46 mm height (socket included) that you can replace very easily by removing the silicone ring and rotating the bulb.



CAGU10R11
H 46mm, L 34,5mm
3,2W - 2700K - 260 Lm





LAMP SHADES

COMPONENTS - CAGES AND LAMP SHADES

Do you want to enrich and customize your pendant?
Choose among Creative-Cables lampshades: naked frames,
handmade ceramic, metal discs, fabric shades and more!

Bulb cages

Our lampshades laid bare! Choose naked lampshades
for a surprising scenic effect to create modern pendant
lamps with one or more pendant and complete your light
with a design bulb in plain sight.



E27, L 210mm, H 200mm

- PAM05VB
- PAM05VN
- PAM05RA
- PAM05GO
- PAM05VR
- PAM05VT



L 150mm, H 210mm

- PAM06VB
- PAM06VN
- PAM06RA
- PAM06GO



E27, L 290mm, H 235mm

- PAM25VB
- PAM25VN



E27, L 125mm, H 170mm

- KPAM24VB0SVB0
- KPAM24VNSVN
- KPAM24VNSRA
- KPAM24VNSGO
- KPAM24VNSCR



L 130mm, H 320mm

- PAM04VN



L 110mm, H 300mm

- PAM03VN



E27, L 280mm, H 240mm

- KPAM18VBLBIA
- KPAM18VN0NER

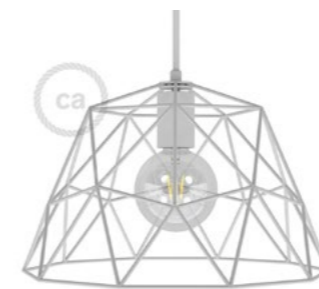

E27, L 350mm, H 240mm

- KPAM23VBL
- KPAM23VNO
- KPAM23VRL



E27, L 280mm, H 240mm

- KPAM19VBLBIA
- KPAM19VN0NER

Lampshades

If you are looking for a lampshade to complement your hanging, table or ceiling lamp, you will find solutions in different materials and sizes to suit the many interior design needs. Handmade ceramic lampshades perfect for kitchens and dining tables, metal spotlight to create contemporary atmospheres, classic shades for table and wall lamps, funny wooden lampshade in limited editions: we have a solution for many tastes and interior design needs.

Metal shades



- DMBIA
- DMNER
- DMRAM
- DMCOR

L 400mm, H 3mm



- DDBIA
- DDNER
- DDRASOTS

L 400mm, H 3mm



- PAM09VBL
- PAM09VNL
- PAM09VVL

E27, L 380mm, H 200mm



- PAM10VBL
- PAM10VNL
- PAM10VVL

E27, L 300mm, H 150mm



- PAM13VNO
- PAM13VRL
- PAM13VNL
- PAM13TIS
- PAM13RAS
- PAM130TS

E27, L 300mm, H 60mm

- PAM13PE
- PAM13VE
- PAM13SB
- PAM13MU



- PAM20VBL
- PAM20VNL

E27, L 300mm, H 250mm



Source: @atomia.eu



Handmade ceramics,
 a material of refinement and
 style through the centuries and
 still today.

Ceramic shades



L 250mm, H 420mm

- EKCABIAN
- EKCACEBI
- EKCARUBI
- EKCALABI



L 250mm, H 260mm

- EKCTBIAN
- EKCTCEBI
- EKCTRUBI
- EKCTLABI



L 130mm, H 190mm

- EKMCBIBI
- EKMCCEBI
- EKMCRUBI
- EKMCCLABI
- EKMCRABI



E27, L 305mm, H 140mm

- EKPSBIAN
- EKPSCEBI
- EKPSRUBI
- EKPSNERA



Near Florence, there is a place of excellence, where the ancient pottery tradition meets the inventiveness of Creative-Cables' designers to conjure up lamp holders, ceiling roses and lampshades of the highest quality. And the expert hands of the team of painters decorate every single component to give you unique 100% made-in-Italy products.



E27, L 130mm, H 150mm

- EKBIBIAN
- EKBICEBI
- EKBIRUBI
- EKBISTAVN
- EKBISTRSS
- EKBISTTC
- EKBISTTRT
- EKBISTVRB
- EKBOLABI



E27, L 150mm, H 280mm

- EKBOBIAN
- EKBOCEBI
- EKBORUBI
- EKBOSTAVN
- EKBOSTRSS
- EKBOSTTC
- EKBOSTTRT
- EKBOSTVRB
- EKBILABI



E27, L 240mm, H 140mm

- EKBIAN
- EKCEBI
- EKIRUBI
- EKSTAVN
- EKSTRSS
- EKSTTC
- EKSTTRT
- EKSTVRB
- EKLABI



E27, L 310mm, H 40mm

- EKPCBIAN
- EKPCCEBI
- EKPCRUBI
- EKPCNERA





From the heart of Tuscany, **our lampshades** are made by hand but created by passion.



A fusion of craftsmanship and modern technological innovation brings to life our entirely handsewn fabric lampshades. Ancient knowledge passed on from father to son, which today brightens up your spaces with the guarantee of the distinguishing Tuscan high-quality craftsmanship.

Fabric shades



E27, L 150mm, H 180mm

- PARCIE27TENER
- PARCIE27TEGIV
- PARCIE27ARGRI
- PARCIE27LIBIA
- PARCIE27CIPET
- PARCIE27ELPIN
- PARCIE27TEBOR
- PARCIE27CAMAR
- PARCIE27CIARA
- PARCIE27TSARG
- PARCIE27TEVOL
- PARCIE27TSRAM



PARCIE27RNGC
E27, L 150mm, H 180mm



E27, L 200mm, H 130mm

- PARIME27JGGG
- PARIME27JNGN
- PARIME27JGGGS
- PARIME27CINEOR
- PARIME27TEAN



E27, L 240mm, H 150mm

- PARE272415BIA
- PARE272415NEOR
- PARE272415JUT

Fibre lampshades

Dome



	Ø 250mm	Ø 350mm		Ø 250mm	Ø 350mm
	PAT1XS-CP0953	PAT1M-CP0861		PAT1XS-CP0938	PAT1M-CP0846
	PAT1XS-CP0947	PAT1M-CP0855		PAT1XS-CP0951	PAT1M-CP0859
	PAT1XS-CP1614	PAT1M-CP1638		PAT1XS-CP0948	PAT1M-CP0856
	PAT1XS-CP0945	PAT1M-CP0853		PAT1XS-CP1341	PAT1M-CP1337
	PAT1XS-CP1619	PAT1M-CP1643		PAT1XS-CP1620	PAT1M-CP1644
	PAT1XS-CP1612	PAT1M-CP1636			

Sphere



	Ø 250mm	Ø 350mm		Ø 250mm	Ø 350mm
	PAT2XS-CP0210	PAT2M-CP0128		PAT2XS-CP0197	PAT2M-CP0115
	PAT2XS-CP0204	PAT2M-CP0123		PAT2XS-CP0208	PAT2M-CP0126
	PAT2XS-CP1555	PAT2M-CP1590		PAT2XS-CP0205	PAT2M-CP0124
	PAT2XS-CP0202	PAT2M-CP0121		PAT2XS-CP1349	PAT2M-CP1345
	PAT2XS-CP1560	PAT2M-CP0121		PAT2XS-CP1561	PAT2M-CP1596
	PAT2XS-CP1553	PAT2M-CP1588			

Cement shades



L 130mm, H 250mm

- KPAC01CGL
- KPAC01CGD



L 150mm, H 220mm

- KPAC03CGL
- KPAC03CGD



L 200mm, H 260mm

- KPAC02CGL
- KPAC02CGD

UFO UNCONVENTIONAL FLYING OBJECT

The project

We selected 7 famous & promising emerging artists, we chose two of their most representative artworks and we lit them up: this is how the UFO collection - Unconventional Flying Objects was born. 7 double-faced wooden disks, processed and printed in Italy, ready to become a wall or a suspension lamp. Well, actually two: both sides of the disk are illustrated with different designs! Men and women, cactus and pineapples, mandala and azulejos, ice cream and cupcakes, and not to forget fish, dogs and flamingoes: A surprising variety of subjects and colours that create playful, romantic or surreal atmospheres.



LPWUF003
Davide Bonazzi



LPWUF004
Fernando Cabelo



LPWUF005
ODD



LPWUF006
Chiara Fucà



LPWUF008
Francesco Poroli



LPWUF012
Annachiara Zaminato

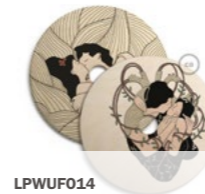

LPWUF014
Carolina Zuniga

UFO Natural and Colour

In addition to the line of illustrated UFOs, there are versions in natural and painted wood. Their minimal a captivating functional design is perfect for those who want to recreate a modern and Scandinavian style of furniture. Natural wood can be painted or varnished to suit your needs and your creative projects, while the painted version is distinguished by a palette of pastel colours, from the brightest to the most delicate, perfect for children's room, modern living rooms or kitchens.



E27, Ø 330mm, H 5mm

LPWUFONAT



E27, Ø 330mm, H 5mm

- LPW6019
- LPW1015
- LPW3020
- LPW7039
- LPW3015
- LPW5020

ACCESSORIES

Small things can make a difference: among our accessories you will find all the special components which can make your lamp 100% unique.

Pinocchio

Pinocchio is Creative Cables adjustable wall mount for pendant lamp: it is made in Italy out of 100% beachtree wood and it can be polished or painted as desired. The cable doesn't go through any holes, it is wrapped around ridged wooden supports at each end: we strongly recommend you to use it with Snake, Snake for lampshades and SnakeBis. Pinocchio makes it possible to hang a lamp onto a wall, even with a lampshade with a 50cm maximum diameter and a 3,365 kg maximum weight.

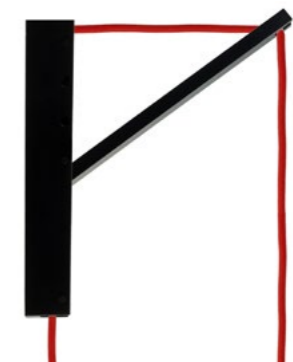
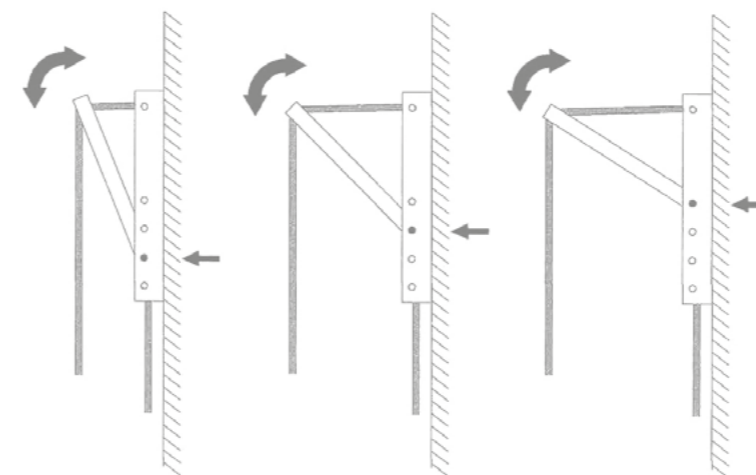

- SSTLN02
- SSTLN03
- SSTLN01

Pinocchio can also be adjusted at three different heights.

ACCESSORIES AND FIXTURES

Source: Woodland House by RYV Architeti - PH Alessandro Santi

Pinocchio XL

Pinocchio XL is not a simple wall bracket! It is Creative-Cables' solution to hang your lamp where you need it, allowing you to adjust the distance and the position of the light source from the wall. Thanks to the groove in the last rod, the cable remains locked in a safe position.

Made (in Italy!) from untreated beechwood, it can be impregnated or painted with the colour you want. And if you wish to add a lampshade, you can complete your installation with the ceiling brackets included in the kit.

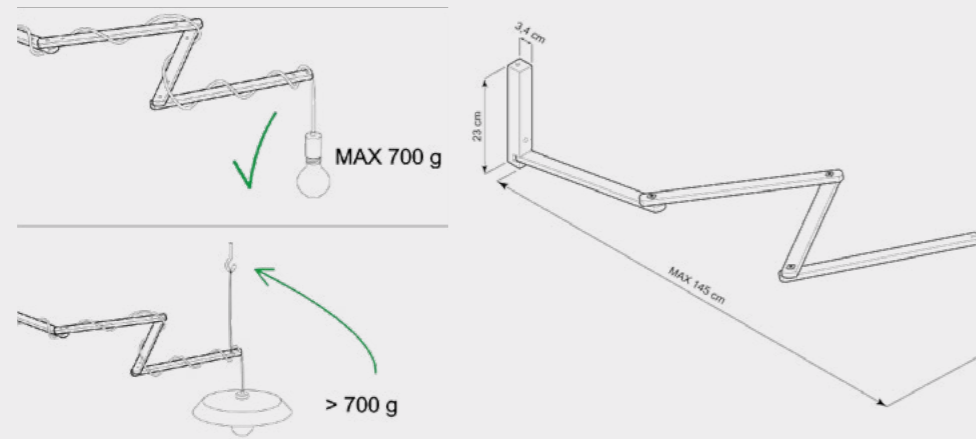

ZIGH-ZAGH

Zigh-Zagh is the ceiling support that allows you to create original pendant lamps, adapting both the shape and the length to every situation. Made in Italy, it can also be impregnated or painted with whichever colour you like. Included in the kit is a thin transparent thread and the ceiling hooks needed to hang up your creation.

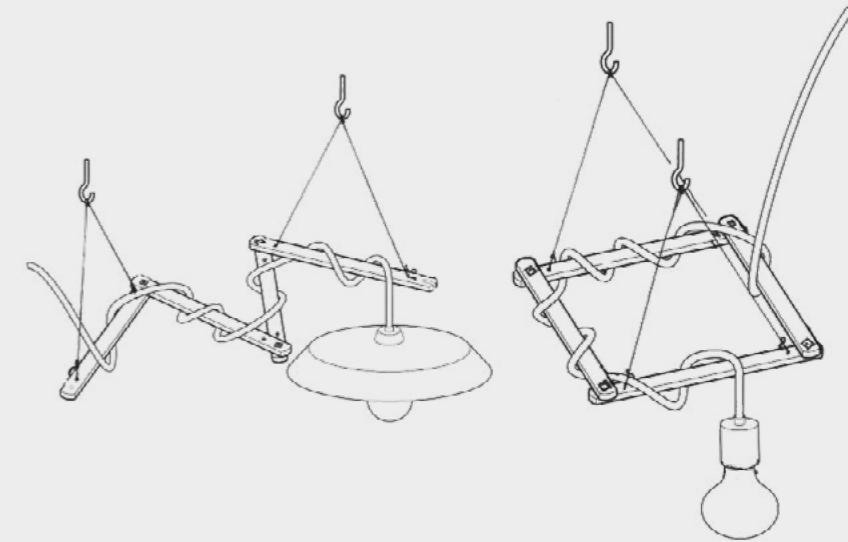

Rolè

The Rolè wooden cable tie is an ideal wall fixture for creating beautiful wall lighting solutions in your indoor spaces. It can be used to decentralise the fall of a pendant lamp, or, thanks to the use of many cable ties in a sequence, by stretching the electric cable from one to the other, you can draw on your walls to design creative installations... and why not, you can use Rolè as a coat rack!

Rolè is made of 100% Italian-made wood and is available in two different finishes: beechwood and wenge-effect ash wood.



Archet(To)

Archet(To) is Creative-Cables patented and Made in Italy solution to create a suspended lamp that can be hung onto a wall, even with a lampshade with a 70cm maximum diameter and a 3,365 kg maximum weight: Archet(To) bends according to the weight it is bearing. it has a light structure in transparent polycarbonate and can be used with Snake, Snake for lampshades and SnakeBis.

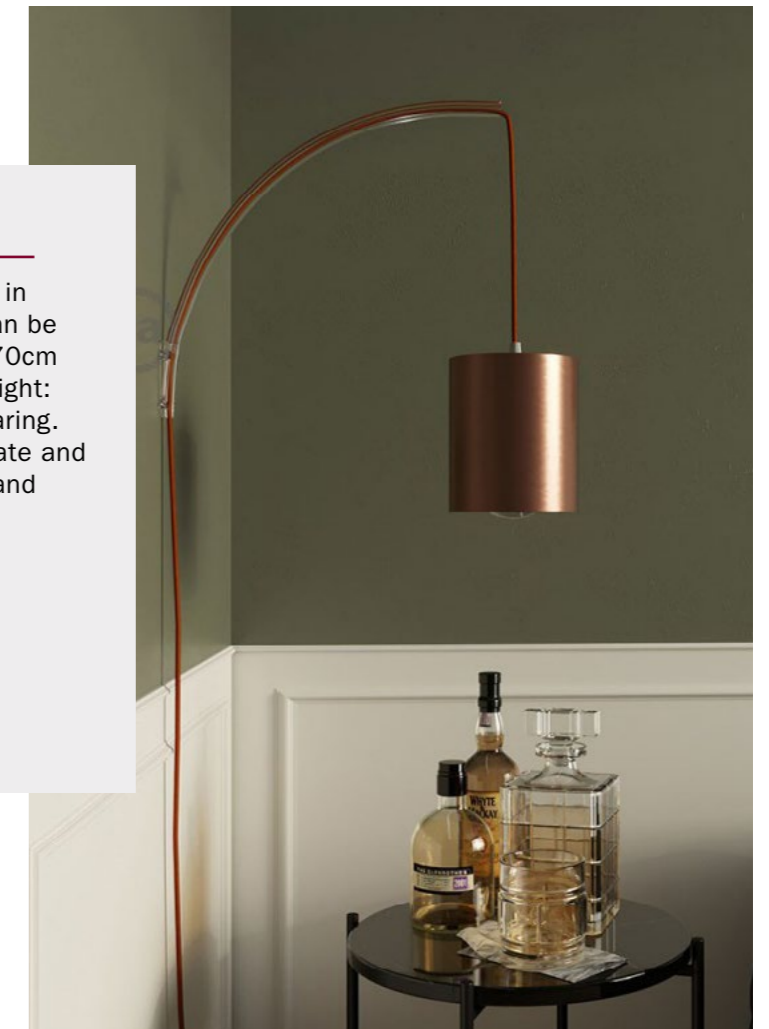

To mount Archet(To) on a wall lightpoint, you may want to use the designated bases in natural and made-in-Italy wood. The bases can be polished or painted as desired.



- KRLQARC
- KRLQARC02
- KRLQARC03

Cable Clamps

Cable Clamps are not just a safety feature: they can actually be beautiful and decorative! The metal cable clamps are available in standard size (1,7cm) and XL size (7cm and 15cm).

Plastic



Metal

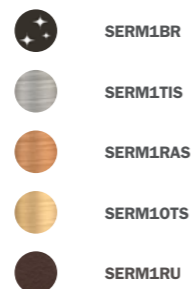
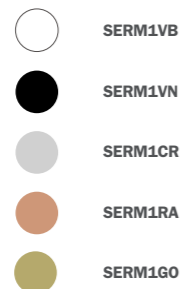

XL-7cm

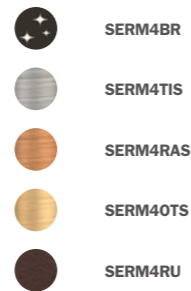
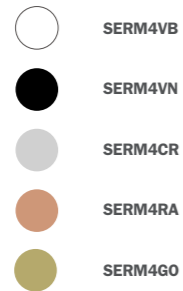

XL-15cm

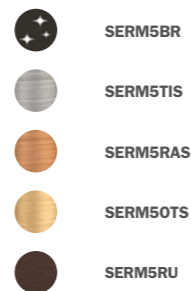
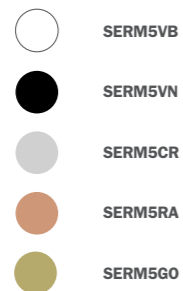

Wall Fixtures

Fairleads, hooks, decentralizers: these small pieces will give shape to your installation and allow you to run your cables exactly in the way you imagined!

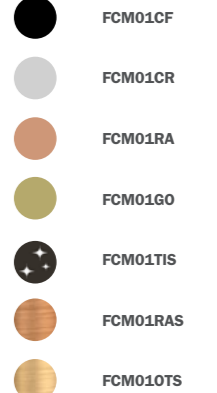
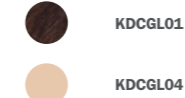
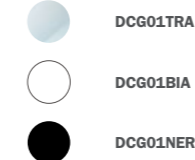
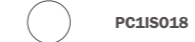

Extension Pipes

Straight and bent extension pipes are available in different finishes and lengths: they can creatively customize a wall or table lamp.

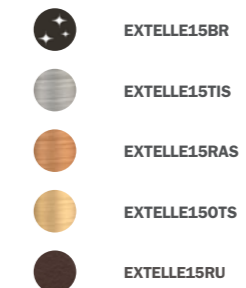

	5cm	10cm	15cm	20cm	25cm	30cm
	EXT05VB	EXT10VB	EXT15VB	EXT20VB	EXT25VB	EXT30VB
	EXT05VN	EXT10VN	EXT15VN	EXT20VN	EXT25VN	EXT30VN
	EXT05CR	EXT10CR	EXT15CR	EXT20CR	EXT25CR	EXT30CR
	EXT05RA	EXT10RA	EXT15RA	EXT20RA	EXT25RA	EXT30RA
	EXT05GO	EXT10GO	EXT15GO	EXT20GO	EXT25GO	EXT30GO
	EXT05BR	EXT10BR	EXT15BR	EXT20BR	EXT25BR	EXT30BR
	EXT05TIS	EXT10TIS	EXT15TIS	EXT20TIS	EXT25TIS	EXT30TIS
	EXT05RAS	EXT10RAS	EXT15RAS	EXT20RAS	EXT25RAS	EXT30RAS
	EXT050TS	EXT100TS	EXT150TS	EXT200TS	EXT250TS	EXT300TS
	EXT05RU	EXT10RU	EXT15RU	EXT20RU	EXT25RU	EXT30RU



	TBS1BR		TBS1TIS
	TBS1CR		TBS1RAS
	TBS1RA		TBS10TS
	TBS1GO		

Other accessories

Complete your project and satisfy your home-decorating urges with threaded tubes, threaded rods and wooden height adjusters. Some products are sold individually or in bulk boxes (10 or 100 pieces). Threaded tubes sizes available: 1cm - 1,5cm - 2cm - 2,5cm



30180



ELEG03





1cm 1,5cm 2cm 2,5cm

PC10TIGE10 PC10TIGE15 PC10TIGE20 PC10TIGE25



Compatible with 2XL rope cables (24mm)

 KTERCLS01
 KTERCLS04

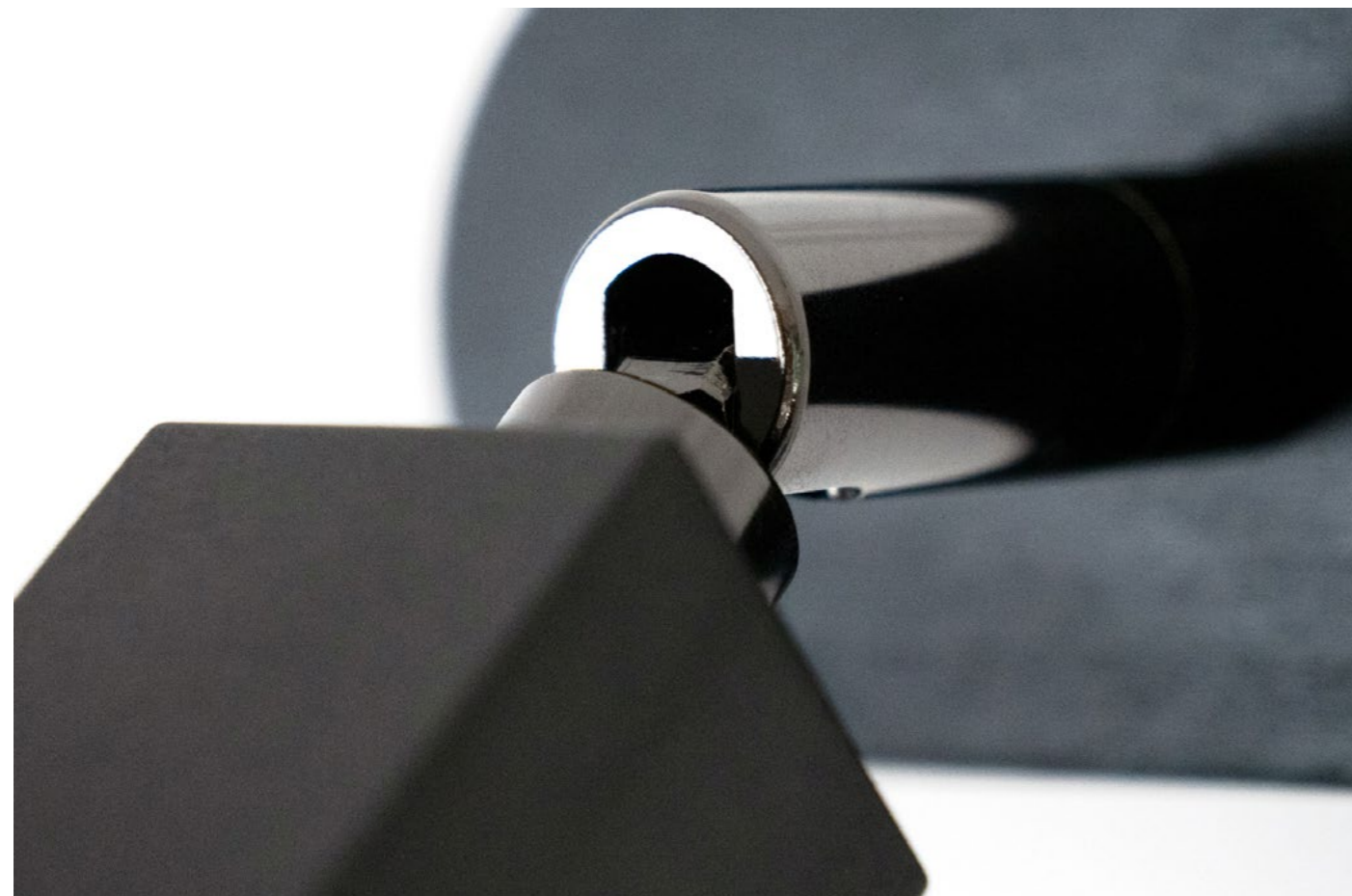

Wooden feet Kit - table lamp support

These beechwood feet made in Italy have a supporting purpose, allowing you to transform a lampshade into a table lamp base. They are equipped with double-sided adhesive tape to secure the lampshade and felt pads on the underside to ensure protection and adherence to the supporting surface. The wooden feet are available in different finishes to allow for a pleasant harmonious effect of your installation.



Taché, light bulb support

Taché, in Piedmontese means "to attach" or "to fix": our Taché is a support for light bulbs that allows you to transform a Globe 125 into an original table lamp. Designer Fabrizio Alessio has imagined to adapt William Middlebrook's idea (the paper clip) to the world of lighting, by drawing from its elegance and simplicity: just as the paper clip staples sheets of paper, Taché's super-light structure can staple the globe of any G125 bulb, leaving it suspended and in view. The Taché consists of two mirrored arms with an aluminium wire frame covered with a braid made from the fabric of our cables and two elegant Made in Italy wooden feet. As well as a decorative function, the covering sleeve protects the bulb's surface.

TACHÉ
DESIGN BY FABRIZIO ALESSIO



- TCHRM04
- TCHRZ26
- TCHRM27
- TCHRM09
- TCHRZ11
- TCHRX14
- TCHRT41



COMPONENT OR LAMP?

Taché can be purchased as is or completed with one of our SnakeBis plug-in lamps to create a practical, modern and creative table lamp.

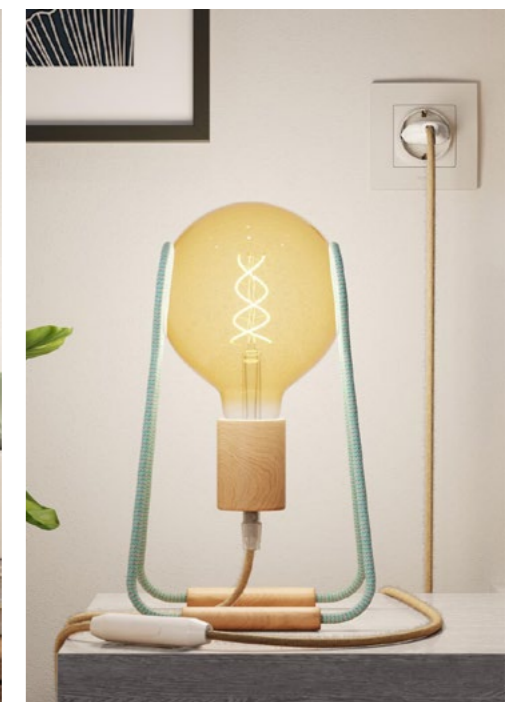

MINI-UFO - REVERSIBLE WOODEN DISK FOR POSALUCE

Customizing your wooden Posaluce table lamp is easier with MINI UFO!

2 collections and numerous designs to create the unique table lamp. Perfect to decorate your room or as a gift: you just have to place the MINI-UFO over the central element of the Posaluce and add a light bulb. MINI UFOs are made of poplar wood and are reversible: you can choose which side you want to show and change it anytime you want! Processed and printed in Italy.

MINI-UFO READING BALLSH*T

The Reading Ballsh*t collection states ironically the most common lies told by readers, illustrated in the unmistakable style of Lepalle.it: the collection is dedicated to readers, who are known to be the finest and snobbiest liars.

Quotes are available both in English and in Italian: choose from the 4 available options the one that better suits your bookworm spirit!



MINI-UFO PEMBERLYBOND

Pemberley Pond is the name of the duo which illustrated the cover of "Goodnight Stories for Rebel Girls", one of the most successful children's books of recent years. Thanks to their unmistakable calligraphic style, 8 quotes inspired by the pleasure of reading have become 4 double-faced MINI-UFOs: they all share a playful and naive style and are ideal in the room of baby readers, to illuminate their first books and accompany them in the pleasure of reading.





ELECTRICITY

Every electrical accessory you can think of to create your own personal design: plugs, sockets, switches, dimmers, and much more.
All certified to the strictest Italian and European safety standards.

Switches designed by Achille Castiglioni

The legendary 450, produced by the then VLM of Buccinasco, was born more than 50 years ago from the pencil of one of the greatest protagonists of Italian design, winner of nine Golden Compasses.

The sound of the operating 'click' has entered the collective imagination of every person since, as this small amazing object has been produced more than 25 million times.

But 450 isn't the only switch designed by Achille and Pier Giacomo Castiglioni: there are two "big brothers" designed for floor and table lamps: the 661 and the 662.



Qualità del progetto a firma di Achille e Piergiacomo Castiglioni

*Quality of project by
Achille and Pier Giacomo
Castiglioni*



- CAST450N
- CAST450B
- CAST450T



Creative Switch

Tired of the classic single-colour switch?
With the Creative Switch, you can combine the shell of the switch with 6 different colours of the button and create the perfect combination with our cables.
All you have to do is customise your lamp in every detail, even the switch!

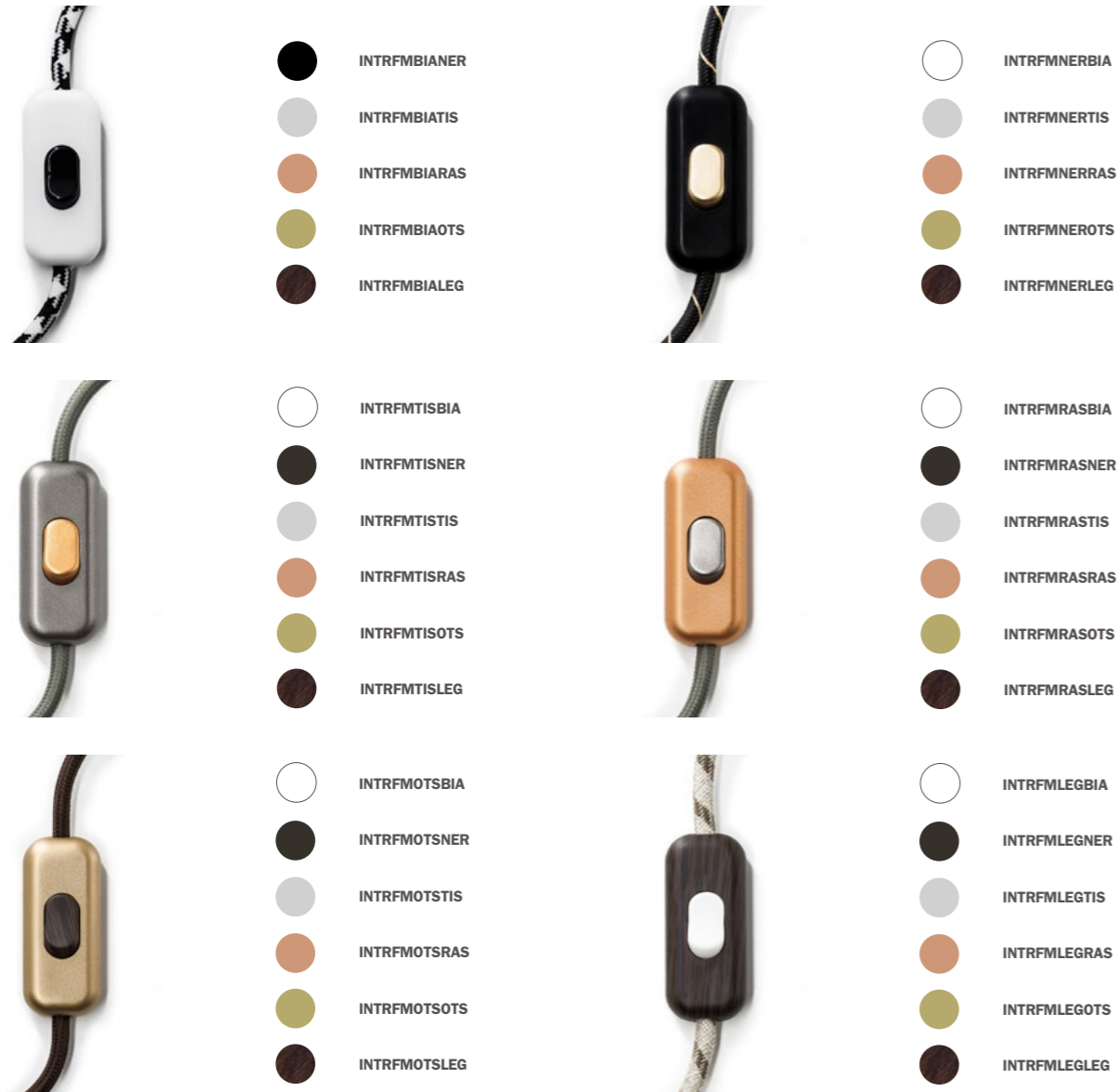

Creative Plug

Give your lamp a boost of colour by combining the 6 colours of Creative Plug with the different options of Creative Switch.
Creative European Plug is compatible with all our 2x0.75 cables and can be combined with other Creative Cables components.



The extra idea

Find the perfect combination with one of our cables such as Vertigo (Creative-Cables exclusive) to personalise your lamp in every detail. Let your creativity run wild!



Switches

Our switches are ideal for creating your table or floor lamp on your own.



Plugs and sockets

Our plugs and sockets are ideal for creating your table or floor lamp wiring on your own.

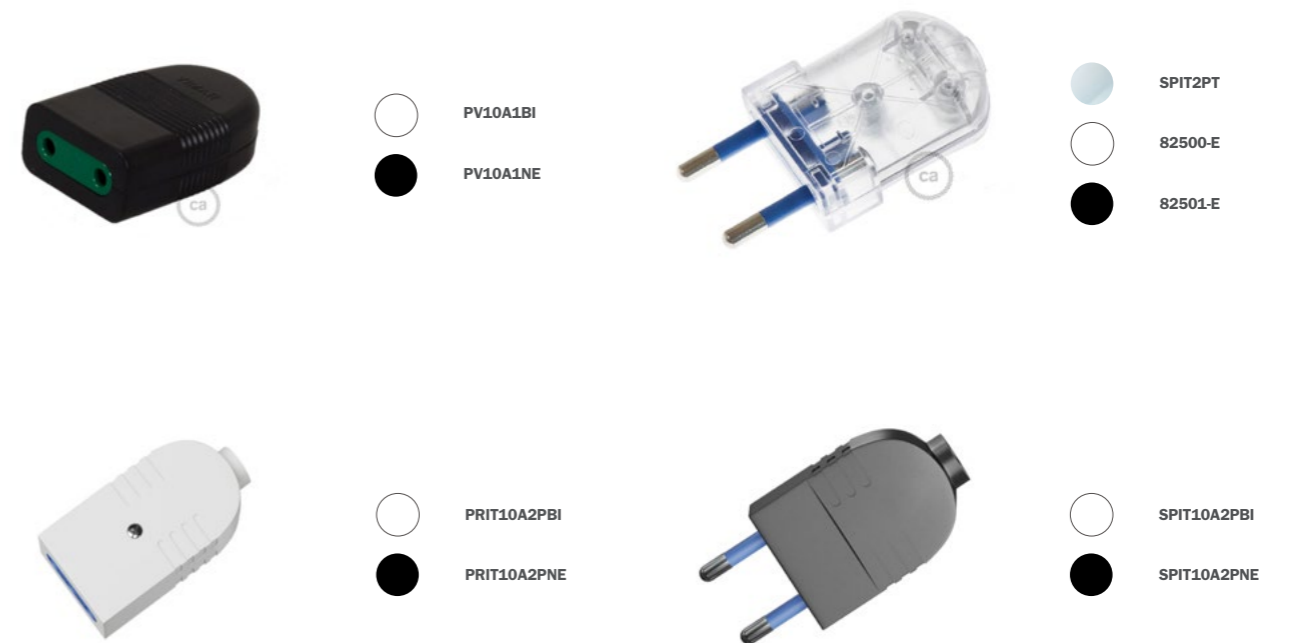

Dimmer

Dimmers let you adjust the light intensity of a light bulb according to your personal need.



-  ARD037399
-  ARD037536
-  ARD036827
-  ARD037433



DIM551010

Electric accessories

Splicing connectors are essential for completing your lighting installations. They are sold individually or in bulk boxes (10 or 100 pieces).



MOR412



MOR413



MOR415

Connection kit for flush-mounted ceiling roses

The connection kit for suspension with flush-mounted ceiling rose enables fast and secure connections. The plastic box acts as insulation, protecting the connectors inside and it is equipped with two cable clamps, one on each side, which ensure the safety and solidity of the cables.



-  MORINC





-  KTRACB
-  KTRACN



-  PRSEUB
-  PRSEUN



-  82510-E
-  82511-E





-  PVF16A1BI



-  PVT16A1BI





-  ST16A1BI
-  ST16A1NE





-  80052



-  80070-E
-  80071-E



-  SPIN3PBI
-  SPIN3PN

Adaptors for tracks

Thanks to this multiadaptor you can enrich your electrified track with some suspended lights made with our fabric cables, that can be placed and mounted where desired.



BULBS

A60 - E27



DL700200
H 106mm, L 60mm
7W - 2700K - 806 Lm



DL700182
H 106mm, L 60mm
7W - 2700K - 806 Lm



DL700289
H 106mm, L 60mm
7W - 2700K - 806 Lm



DL700137
H 105mm, L 60mm
3W - 2200K - 150 Lm



CBL700138
H 105mm, L 60mm
3W - 2000K - 150 Lm



CBL700169
H 104mm, L 60mm
7,5W - 2700K - 806 Lm



CBL700100
H 108mm, L 60mm
6.5W - 3000K - 450 Lm



CBL700101
H 108mm, L 60mm
6.5W - 2700K - 806 Lm



DL700170
H 104mm, L 60mm
8W - 2700K - 1055 Lm



DL700171
H 104mm, L 60mm
8W - 4000K - 1055 Lm



DL700345
H 70mm, L 126mm
15W - 2700K - 2200 Lm



DL700343
H 70mm, L 126mm
12W - 2700K - 1800 Lm

G95 - E27

Shape Fitting



Dimmable

DL700250

Reference

H 138mm, L 95mm

6W	-	2700K	-	540 Lm
Power		Colour temperature		Light emission

A70 - E27



DL700387
H 126mm, L 70mm
11W - 2700K - 1521 Lm



DL700389
H 126mm, L 70mm
11W - 2700K - 1521 Lm

G45 - E27



DL700675
H 78mm, L 45mm
2W - 2700K - 136 Lm



DL700670
H 78mm, L 45mm
1.4W - 80 Lm



DL700673
H 78mm, L 45mm
1.4W - 13 Lm



DL700671
H 78mm, L 45mm
1.4W - 75 Lm



DL700672
H 78mm, L 45mm
1.4W - 16 Lm



DL700674
H 78mm, L 45mm
2.2W - 2700K - 136 Lm

ST64 - E27



DL700181
H 145mm, L 64mm
5W - 2000K - 150 Lm



CBL700727
H 146mm, L 64mm
5W - 2200K - 280 Lm



DL700143
H 146mm, L 64mm
5W - 2200K - 280 Lm



DL700144
H 146mm, L 64mm
5W - 2000K - 250 Lm



CBL700148
H 78mm, L 45mm
3W - 2000K - 120 Lm



CBL700149
H 78mm, L 45mm
3W - 2200K - 150 Lm



DL700338
H 45mm, L 75mm
6,5W - 2700K - 806 Lm



DL700339
H 45mm, L 75mm
6W - 2700K - 806 Lm

G45 - E14



DL700136
H 145mm, L 64mm
4W - 2000K - 400 Lm



DL700206
H 145mm, L 64mm
6W - 2700K - 540 Lm



DL700318
H 140mm, L 64mm
5W - 2000K - 250 Lm



DL700119
H 145mm, L 64mm
7.5W - 2200K - 805 Lm



DL700312
H 64mm, L 146mm
5W - 2000K - 250 Lm

G95 - E27



DL700142
H 135mm, L 95mm
5W - 2000K - 250 Lm



DL700180
H 135mm, L 95mm
5W - 2000K - 150 Lm



DL700726
H 135mm, L 95mm
5W - 2200K - 280 Lm



DL700141
H 135mm, L 95mm
5W - 2200K - 280 Lm



DL700320
H 175mm, L 125mm
5W - 2000K - 250 Lm



CBL700174
H 175mm, L 125mm
7W - 2700K - 806 Lm



CBL700175
H 175mm, L 125mm
7W - 2700K - 806 Lm



DL700291
H 175mm, L 125mm
7W - 2700K - 806 Lm



DL700319
H 140mm, L 95mm
5W - 2000K - 250 Lm



DL700176
H 140mm, L 95mm
7W - 2700K - 806 Lm



DL700177
H 140mm, L 95mm
7W - 2700K - 806 Lm



DL700290
H 140mm, L 95mm
7W - 2700K - 806 Lm



CBL700110
H 178mm, L 125mm
4W - 2700K - 470 Lm



DL700397
H 178mm, L 125mm
18W - 2700K - 2452 Lm



DL700167
H 178mm, L 125mm
11W - 2700K - 1521 Lm



CBL700166
H 178mm, L 125mm
7.5W - 2700K - 806 Lm



DL700110DA
H 140mm, L 95mm
4W - 2200K - 400 Lm



DL700121
H 140mm, L 95mm
7.5W - 2200K - 805 Lm



DL700250
H 138mm, L 95mm
6W - 2700K - 540 Lm



DL700135
H 138mm, L 95mm
4W - 2000K - 400 Lm



CBL700108
H 175mm, L 125mm
6W - 2700K - 806 Lm



CBL700116
H 178mm, L 125mm
8W - 2700K - 1055 Lm



CBL700216
H 175mm, L 125mm
5W - 2000K - 250 Lm



DL700232
H 175mm, L 125mm
5W - 2000K - 250 Lm



CBL700111
H 138mm, L 95mm
4W - 2700K - 470 Lm



CBL700165
H 140mm, L 95mm
7.5W - 2700K - 806 Lm



DL700682
H 135mm, L 95mm
2W - 2000K - 40 Lm



DL700311
H 95mm, L 135mm
5W - 2000K - 250 Lm



DL700249
H 176mm, L 125mm
6W - 2700K - 540 Lm



DL7001100DA
H 178mm, L 125mm
4W - 2200K - 400 Lm



DL700120
H 178mm, L 125mm
7.5W - 2200K - 805 Lm



DL700361
H 178mm, L 125mm
5W - 1800K - 270 Lm

G125 - E27



DL700139
H 175mm, L 125mm
5W - 2200K - 280 Lm



DL700140
H 125mm, L 175mm
5W - 2000K - 250 Lm



DL700179
H 125mm, L 175mm
5W - 2000K - 150 Lm



CBL700725
H 125mm, L 175mm
5W - 2200K - 280 Lm

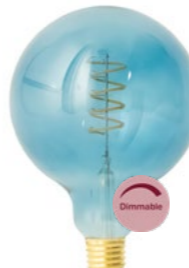

DL700362
H 178mm, L 125mm
5W - 2700K - 180 Lm



DL700266
H 172mm, L 125mm
4W - 2200K - 100 Lm



DL700363
H 178mm, L 125mm
5W - 2500K - 100 Lm



DL700267
H 172mm, L 125mm
4W - 1900K - 150 Lm

G180 - E27



DL700270
H 172mm, L 125mm
4W - 2250K - 150 Lm



DL700134
H 178mm, L 125mm
4W - 2000K - 400 Lm



DL700683
H 175mm, L 125mm
2W - 2000K - 40 Lm



DL700233
H 175mm, L 125mm
5W - 2000K - 250 Lm



DL700234
H 215mm, L 180mm
5W - 2000K - 150 Lm



DL700235
H 215mm, L 180mm
5W - 2000K - 250 Lm

A165 - E27



CBL700146
H 300mm, L 165mm
5W - 2000K - 250 Lm



DL700217
H 300mm, L 165mm
5W - 2000K - 150 Lm



CBL700694
H 300mm, L 165mm
5W - 2200K - 280 Lm



DL700314
H 290mm, L 160mm
12W - 2700K - 1520 Lm



DL700156
H 300mm, L 200mm
5W - 2000K - 250 Lm



DL700218
H 300mm, L 200mm
5W - 2000K - 150 Lm



CBL700693
H 300mm, L 200mm
5W - 2200K - 280 Lm



DL700317
H 283mm, L 200mm
11W - 2700K - 1520 Lm

G200 - E27



DL700316
H 290mm, L 160mm
11W - 2700K - 1520 Lm



DL700210.00A
H 280mm, L 165mm
5W - 2000K - 150 Lm



DL700334
H 290mm, L 160mm
8,5W - 2000K - 600 Lm



DL700315
H 283mm, L 200mm
12W - 2700K - 1520 Lm



DL700323
H 283mm, L 200mm
8,5W - 2000K - 600 Lm

G155 - E27



DL700222
H 200mm, L 155mm
6W - 2700K - 540 Lm



DL700239
H 195mm, L 155mm
7W - 2200K - 580 Lm

Candle - E14



CBL700102
H 100mm, L 35mm
4,5W - 2700K - 470 Lm



CBL700107
H 125mm, L 35mm
4W - 3000K - 440 Lm



CBL700109
H 100mm, L 35mm
4W - 3000K - 440 Lm



DL700337
H 35mm, L 100mm
6W - 2700K - 806 Lm



DL700341
H 35mm, L 100mm
6W - 2700K - 806 Lm

Tubular - E27



CBL700173
H 290mm, L 38mm
5.5W - 2000K - 470 Lm



CBL700172
H 110mm, L 45mm
5W - 2000K - 360 Lm



DL700193
H 315mm, L 75mm
8.5W - 2000K - 1055 Lm



SEG50198
H 550mm, L 32mm
12W - 2000K - 560 Lm



SEG50197
H 360mm, L 32mm
8W - 2000K - 380 Lm

Tubular - E14



DL700258
H 120mm, L 30mm
4W - 2700K - 400 Lm



Linear - S14d

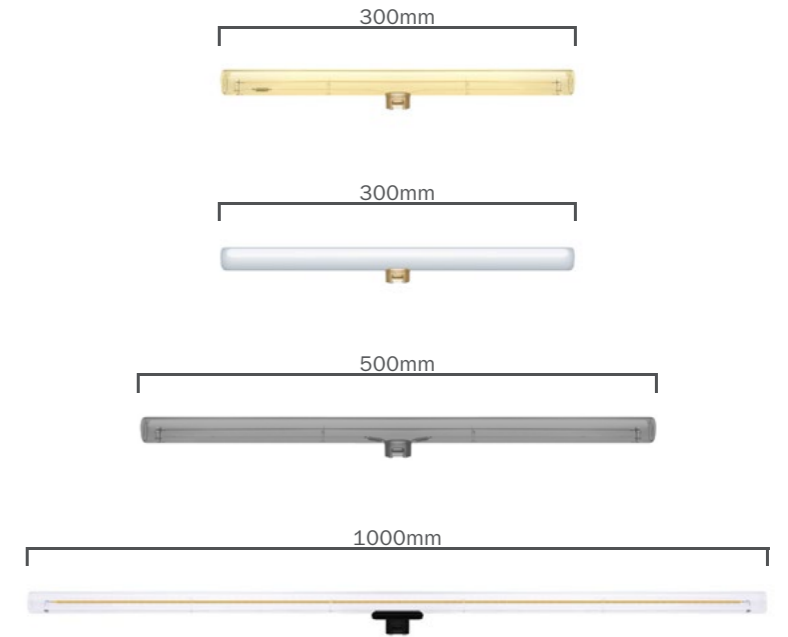
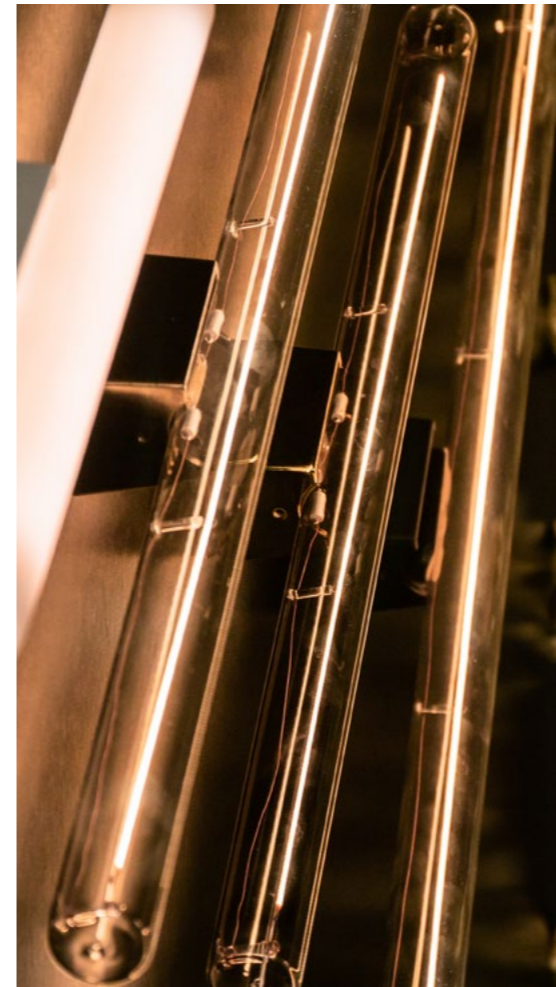

	300mm	500mm	1000mm
	SEG50182 8 W - 300 Lm	SEG50186 12 W - 440 Lm	SEG50192 13 W - 720 Lm
	SEG50183 8 W - 350 Lm	SEG50187 12 W - 500 Lm	SEG50194 13 W - 720 Lm
	SEG50184 8 W - 100 Lm	SEG50188 12 W - 240 Lm	SEG50195 13 W - 350 Lm
	SEG50181 8 W - 350 Lm	SEG50185 12 W - 560 Lm	SEG50190 13 W - 720 Lm

Linear - E27



	500mm	1000mm
	SEG50218 12 W - 600 Lm	SEG50219 13 W - 780 Lm

XXL - Porcelain



DL700247
H 153mm, L 200mm
6W - 2700K - 540 Lm



DL700245
H 170mm, L 143mm
6W - 2700K - 540 Lm



DL700240
H 170mm, L 125mm
6W - 2700K - 540 Lm



DL700246
H 195mm, L 180mm
6W - 2700K - 540 Lm



DL700242
H 130mm, L 118mm
6W - 2700K - 540 Lm



DL700349
H 265mm, L 260mm
10W - 2700K - 1000 Lm



DL700350
H 227mm, L 220mm
10W - 2700K - 1000 Lm



DL700241
H 200mm, L 125mm
6W - 2700K - 540 Lm



DL700244
H 215mm, L 165mm
6W - 2700K - 540 Lm



DL700351
H 355mm, L 180mm
13W - 2700K - 1521 Lm



DL700352
H 305mm, L 150mm
13W - 2700K - 1521 Lm



DL700353
H 200mm, L 95mm
13W - 2700K - 1521 Lm



DL700356
H 264mm, L 120mm
13W - 2700K - 1521 Lm



DL700357
H 314mm, L 150mm
13W - 2700K - 1521 Lm



DL700358
H 364mm, L 180mm
13W - 2700K - 1521 Lm

Crystal



DL700276
H 207mm, L 110mm
6W - 2700K - 600 Lm



DL700277
H 202mm, L 80mm
6W - 2700K - 600 Lm



DL700278
H 205mm, L 115mm
6W - 2700K - 600 Lm



DL700282
H 181mm, L 98mm
6W - 2700K - 600 Lm



DL700279
H 163mm, L 90mm
6W - 2700K - 600 Lm



DL700280
H 163mm, L 75mm
6W - 2700K - 600 Lm



DL700281
H 165mm, L 103mm
6W - 2700K - 600 Lm



Floating - E27



SEG50051
H 90mm, L 90mm
8W - 2200K - 380 Lm



SEG50046
H 165mm, L 125mm
8W - 2200K - 350 Lm



SEG50056
H 165mm, L 125mm
8W - 2000K - 260 Lm



SEG50042
H 100mm, L 85mm
8W - 2200K - 380 Lm



SEG50043
H 110mm, L 200mm
8W - 2200K - 400 Lm



Kitchen Line - E27 - XXL



DL700687
H 330mm, L 90mm
5W - 1000K - 90 Lm



DL700685
H 330mm, L 90mm
5W - 2500K - 90 Lm



DL700681
H 330mm, L 90mm
5W - 2000K - 300 Lm

Kitchen Line - E14



DL700686
H 195mm, L 50mm
3W - 1000K - 90 Lm



DL700684
H 195mm, L 50mm
3W - 2500K - 90 Lm



DL700680
H 195mm, L 50mm
3W - 2000K - 250 Lm

Dash - E27



DL700324
H 100mm, L 170mm
6W - 2700K - 610 Lm



DL700326
H 66mm, L 66mm
4W - 2700K - 320 Lm

Dash - E14



DL700348
H 76mm, L 66mm
4W - 2700K - 300 Lm



DL700347
H 100mm, L 170mm
6W - 2200K - 570 Lm

XXL Bona - Pastel Line - E27



DL700265
H 200mm, L 140mm
4W - 2200K - 100 Lm



DL700364
H 204mm, L 140mm
5W - 2700K - 180 Lm



DL700365
H 204mm, L 140mm
5W - 2150K - 190 Lm



DL700366
H 204mm, L 140mm
5W - 2400K - 90 Lm

XXL Cobble - Pastel Line - E27



ES18C220B0
H 245mm, L 220mm
4W - 2200K - 100 Lm



ES18C220DR
H 245mm, L 220mm
4W - 2200K - 100 Lm



DL700371
H 235mm, L 220mm
5W - 2500K - 90 Lm



DL700190
H 245mm, L 220mm
4W - 2100K - 150 Lm



DL700264
H 200mm, L 140mm
4W - 2100K - 150 Lm

Art Line - E27



SEG50144
H 145mm, L 85mm
8W - 2200K - 300 Lm



SEG50145
H 150mm, L 65mm
8W - 2200K - 300 Lm



SEG50149
H 100mm, L 65mm
8W - 2200K - 330 Lm



SEG50151
H 130mm, L 130mm
12W - 2200K - 350 Lm

XXL Egg - Pastel Line - E27



DL700367
H 264mm, L 180mm
5W - 1800K - 230 Lm



ES18E180B0
H 270mm, L 180mm
4W - 2200K - 100 Lm



DL700260
H 270mm, L 180mm
4W - 2200K - 100 Lm



DL700261
H 270mm, L 180mm
4W - 2200K - 100 Lm



SEG50152
H 140mm, L 100mm
12W - 2200K - 350 Lm



SEG50156
H 145mm, L 40mm
12W - 2200K - 500 Lm



SEG50157
H 125mm, L 75mm
12W - 2200K - 500 Lm



SEG50159
H 135mm, L 115mm
8W - 2200K - 500 Lm



DL700262
H 270mm, L 180mm
4W - 2100K - 150 Lm



SEG50148
H 140mm, L 100mm
8W - 2200K - 330 Lm



SEG50160
H 95mm, L 135mm
10W - 2200K - 500 Lm

Art Line - S14d



SEG50176
H 500mm, L 65mm
8W - 2200K - 350 Lm



SEG50175
H 50mm, L 485mm
8W - 2200K - 350 Lm



SEG50174
H 270mm, L 275mm
8W - 2200K - 350 Lm



SEG50173
H 250mm, L 165mm
8W - 2200K - 350 Lm



DL700237
H 307mm, L 110mm
5W - 2000K - 150 Lm



DL700238
H 307mm, L 110mm
5W - 2000K - 250 Lm



DL700191
H 330mm, L 180mm
8,5W - 2000K - 1055 Lm



DL700192
H 440mm, L 120mm
8,5W - 2000K - 1055 Lm



SEG50172
H 240mm, L 140mm
8W - 2200K - 350 Lm



SEG50171
H 200mm, L 190mm
8W - 2200K - 350 Lm



AL102
H 80mm, L 470mm
4W - 3000K - 150 Lm



DL700354
H 197mm, L 190mm
10W - 2700K - 1000 Lm



DL700355
H 325mm, L 210mm
10W - 2700K - 1000 Lm



DL700205
H 87mm, L 50mm
4,5W - 2700K - 330 Lm

Other shapes - E27



CBL700184
H 130mm, L 125mm
5W - 2000K - 110 Lm



DL700183.0DA
H 130mm, L 125mm
5W - 2000K - 150 Lm



DL700259
H 175mm, L 145mm
3W - 2000K - 90 Lm



DL700243
H 112mm, L 64mm
6W - 2700K - 540 Lm



DL700131
H 102mm, L 63mm
5W - 2700K - 400 Lm



DL700132
H 125mm, L 80mm
7W - 2700K - 600 Lm



DL700305
H 140mm, L 185mm
5W - 2000K - 250 Lm



DL700304
H 140mm, L 185mm
5W - 2000K - 150 Lm



DL700335
H 122mm, L 80mm
5W - 2000K - 250 Lm



DL700322
H 440mm, L 120mm
8,5W - 2000K - 600 Lm



DL700321
H 360mm, L 180mm
8,5W - 2000K - 250 Lm



DL700294
H 176mm, L 125mm
3W - 2000K - 140 Lm



DL700145
H 200mm, L 200mm
5W - 2000K - 250 Lm



DL700223
H 90mm, L 275mm
26W - 3000K - 4000 Lm



DL700207
H 75mm, L 180mm
18W - 3000K - 3000 Lm



DL700185
H 360mm, L 160mm
5W - 2000K - 250 Lm



DL700186
H 360mm, L 160mm
5W - 2000K - 150 Lm



DL700187
H 365mm, L 315mm
5W - 2000K - 250 Lm



DL700188
H 365mm, L 315mm
5W - 2000K - 150 Lm

Tattoo Lamps® E27

The LED lamps of the Tattoo Lamp® line undergo a special treatment that makes them frosted and therefore possible to be decorated.



LED CUOREC
H 178mm, L 125mm
4W - 2700K - 420 Lm



LED HALFC
H 178mm, L 125mm
4W - 2700K - 420 Lm



LED KISSC
H 178mm, L 125mm
4W - 2700K - 420 Lm



LED OTTOC
H 178mm, L 125mm
4W - 2700K - 420 Lm



LED PIOC
H 178mm, L 125mm
4W - 2700K - 420 Lm

Custom Design LED Tattoo Lamp® can be personalized with a logo, a claim or a graphic element being part of your corporate identity: it will be an original distinctive element for your business, your point of sale or even a subtle feature for the architectural project you are creating. Write to us for further information!



Lamps for plants E27

These LED lamps help us to maintain healthy flowers and green plants in apartments or greenhouses.



CBL700195
H 135mm, L 95mm
E27 - 12W



CBL700194
H 135mm, L 95mm
E27 - 12W

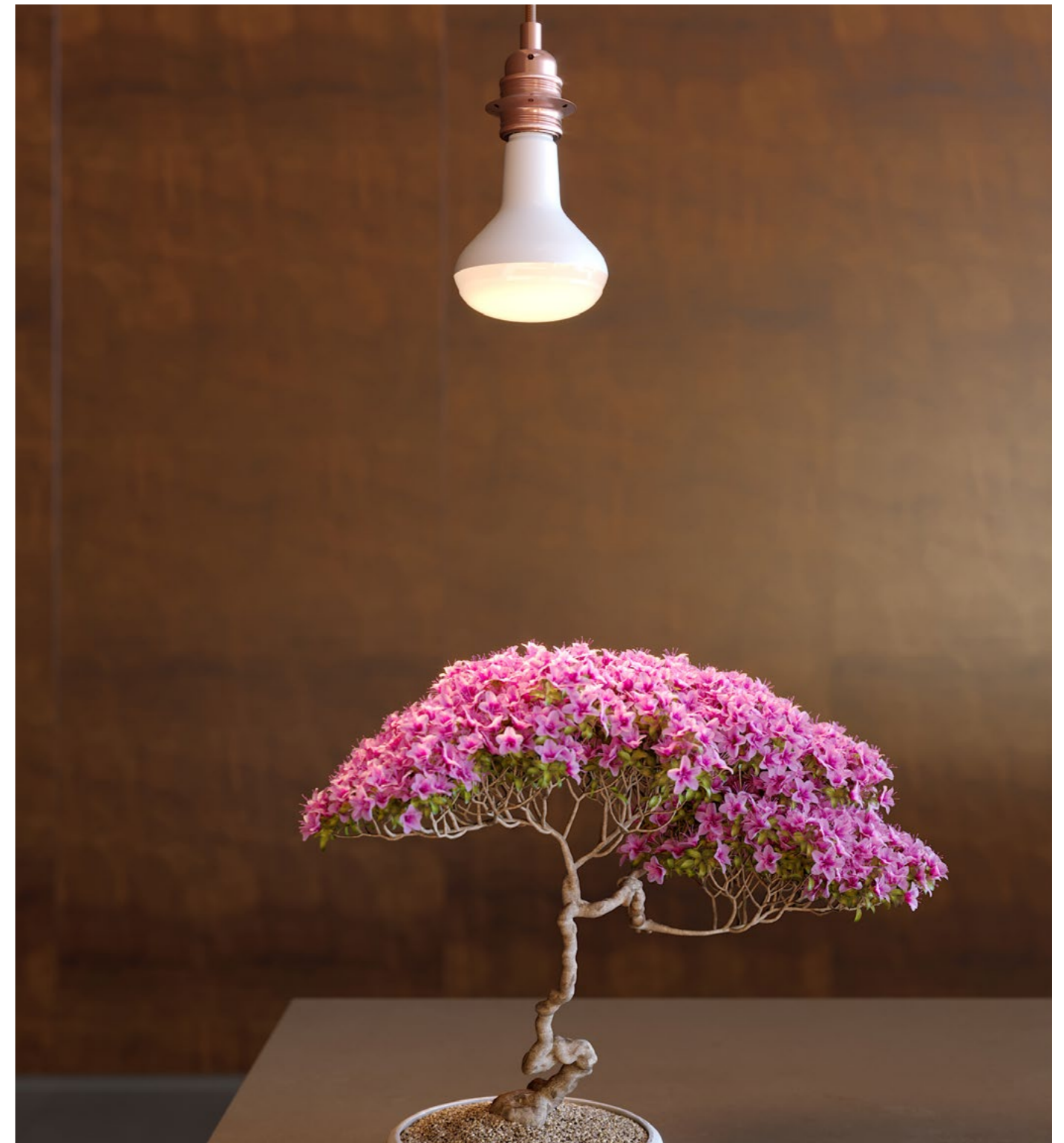

COMPONENTS 108

LAMPS

CONFIGURATOR 234

SINGLE PENDANT	220
SINGLE PENDANT WITH LAMPSHADE	222
MULTI-PENDANT	224
MULTI-PENDANT WITH LAMPSHADES	226
TABLE LAMPS	228
PLUG-IN LAMPS	230
CEILING AND WALL LAMPS	232



LAMPS

AT CREATIVE-CABLES BUYING A LAMP TAKES ON A WHOLE NEW MEANING

At Creative-Cables, lamps can take many shapes and styles in order to adapt to everyone's needs. Here's how to turn your projects into reality:



Lamps designed by us

In our assortment you will find a numerous of options that we've designed for you. You just need to choose the model, the finish and receive it directly where you need it in a few days. You can decide either to receive it already mounted or in a DIY kit!



Personalize any design

Personalizing a Creative-Cables lamp means adapting any of the components to your specific needs: from changing their colors to extending its length as you may need it. Each personalization is free of charge!



Design your own lamp

Use the lamp configurators available on our website to mix and match the components and create the lamp you desire to have. You can decide either to receive it already mounted or in DIY kit!

Have a look at the following pages to get some inspiration!
And, if you need any help our Customer Service is always at your disposal.

SINGLE PENDANT

Choose the material and the finish of the ceiling rose and which cable clamp to match it

Decide type, color and length of the textile cable

Match the lampholder

Select the light bulb



SINGLE PENDANT WITH LAMP SHADE

Choose the material and the finish of the ceiling rose and which cable clamp to match it

Decide type, color and length of the textile cable

Match the lampholder

Select the light bulb

Select the lampshade

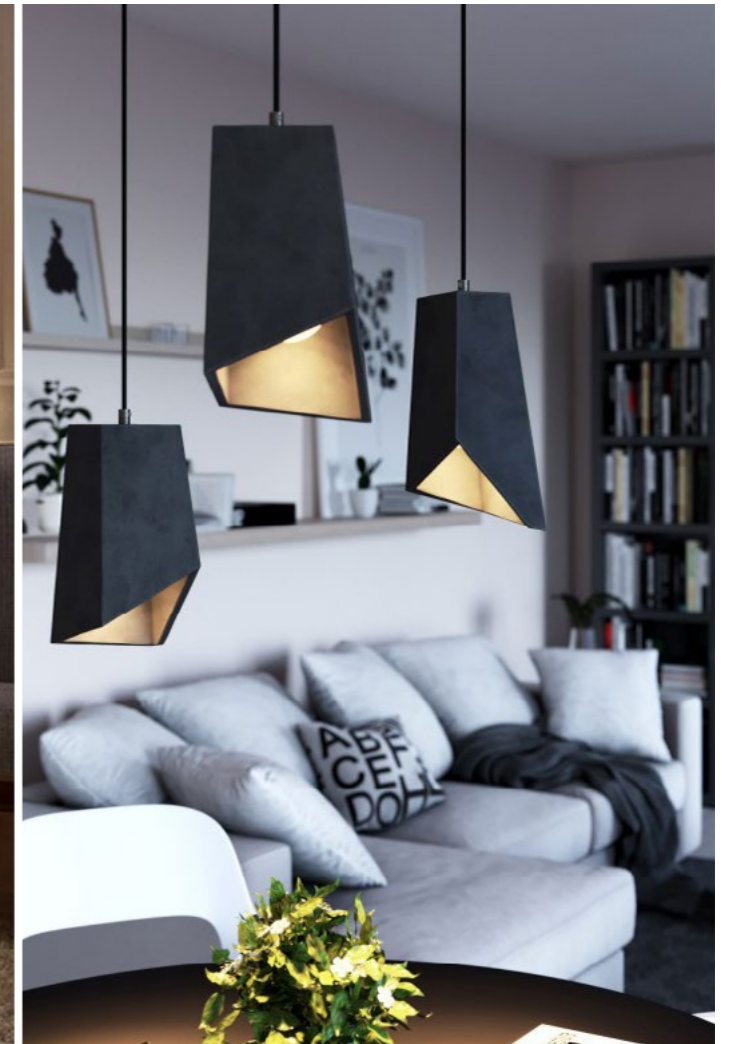

MULTI-PENDANT

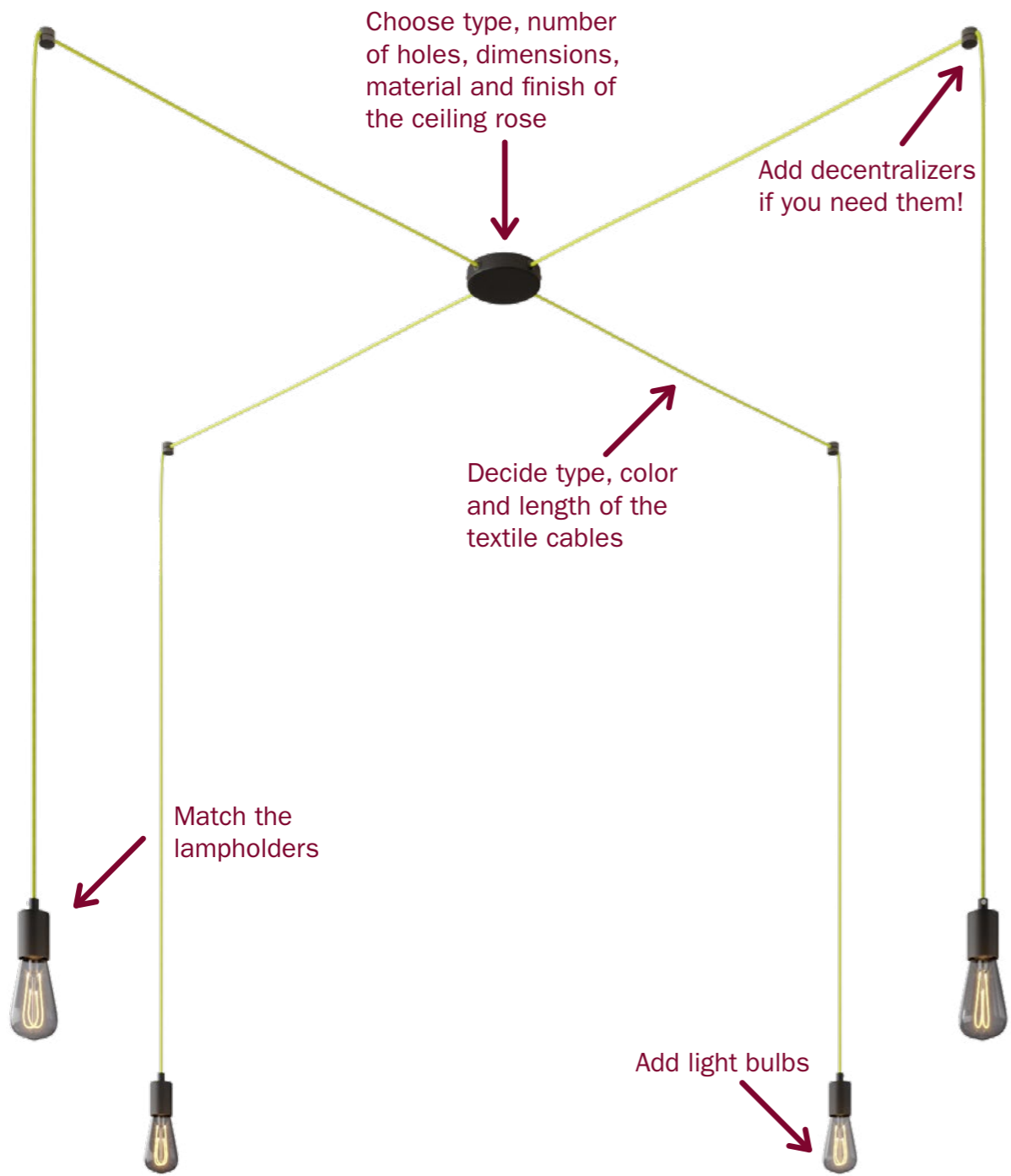

MULTI-PENDANT WITH LAMPSHADES

Choose type, number of holes, dimensions, material and finish of the ceiling rose



Decide type, color and length of the textile cables



Match the lampholders



Add light bulbs



Select the lampshades



Source: @Stab Luce



Source: @halpaintedhouse



TABLE LAMPS

Match the bulb that you prefer or add a lampshade

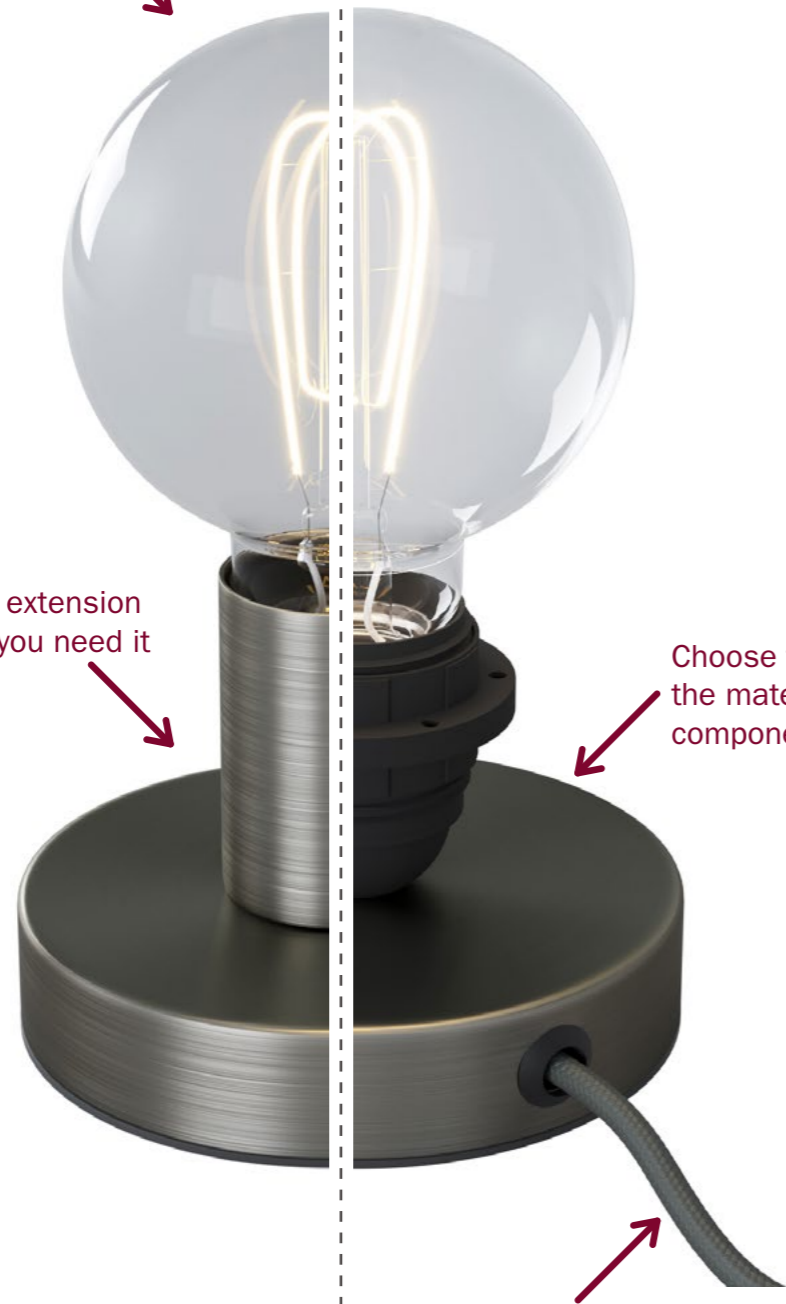

Add an extension pipe if you need it

Choose the finish or the material of the components

Choose the color and the lengths of the cable



PLUG-IN LAMPS

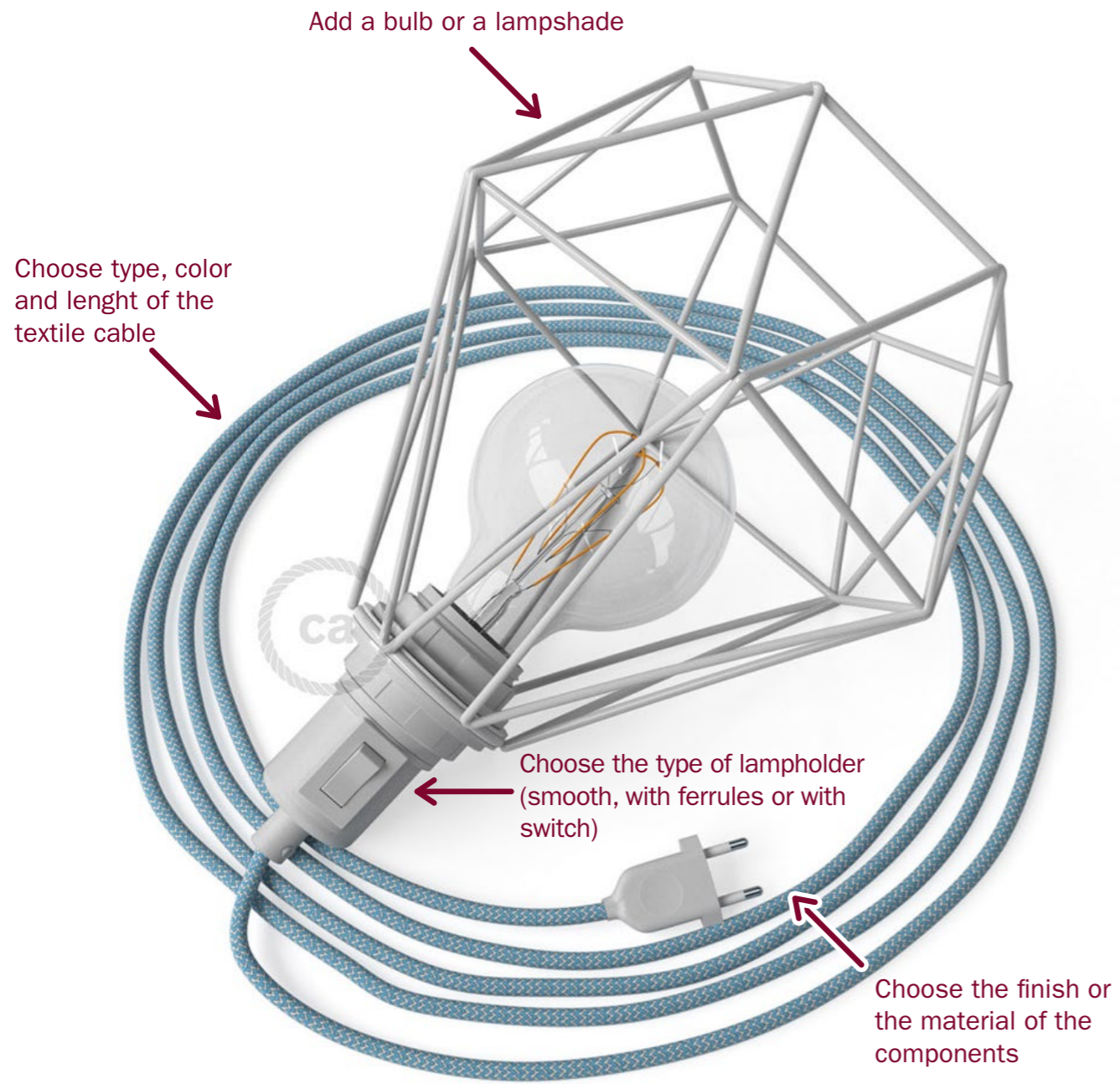

CEILING AND WALL LAMPS



COMPONENTS 108

LAMPS 218

CONFIGURATOR

The lamp just the way you want it

If you have read the catalogue so far you should have noticed, that we are obsessed with CHOICE. Another of our milestones is creativity (after all which is our name?). That's the reason why our **Configurator** gives you the chance to create **YOUR own lamp**, choosing and customising every detail.



Give shape to your fantasy!



OK, let's start! Watch out, we're only explaining to you how the Configurator works... you'll be the one to let your imagination run wild! What can you customise of your lamp? Basically EVERYTHING! The ceiling rose, the cable, the lamp holder, the bulb. And you can also click on the image of the component you're choosing to see more images and technical information about the product.

Choose which lamp do you wish to configure



SINGLE PENDANT LAMPS



MULTIPLE PENDANT LAMPS



OUTDOOR LAMPS



PLUG IN LAMPS



WALL OR CEILING LAMPS



TABLE LAMPS



ELECTRICITY

Ready to go? Go to the configurator!



B2B



B2C

And when you have given shape to your ideas?

Go to the Shopping Cart and complete your lamp order!

B2B SERVICES



Choice

We offer hundreds of IMQ-HAR or UL certified cables made in Italy, complemented by a variety of lighting accessories and high-quality light bulbs that can generate thousands of combinations. Our assortment is regularly reviewed to set or match current lighting trends.



Assembly

We can assemble and certify almost any of our products together to create your desired ready-to-use lamps that only need to be positioned and switched on. Simply nominate the components you need and contact us to receive the best quotes available complete with volume breaks for larger quantities. The more you buy, the more you save.



Customization

Anything can be possible at Creative-Cables. We like to explore your ideas and encourage your creativity: if what you want is feasible, we can make it happen. We are the producer, so ask us if we can create what you need.



Service

Our B2B website is active 24/7: In addition, each B2B customer receives dedicated support from a qualified account manager who can assist you throughout the process before, during and after the sale.



Logistics

B2B orders of any size can be prepared within 5 working days, 80% of our orders are dispatched within 48 hours. We have mastered our efficiency to allow you to receive what you need when you need it. For special customized products or assemblies, we can advise approximate lead times to ensure you have all the information you need to plan accordingly.



Point of sale materials

We have boxed products and sample displays cases. Corners Display Panels are the solution to display a wide selection of products in your store or showroom to maximize sales by properly expressing the idea of possibilities of light installations that can be obtained with Creatives Cables components.

CONFIGURATOR CORNER

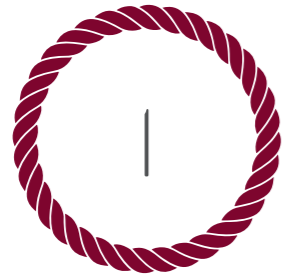

The inspiration

Our architects will design an installation in your shop, with a **few selected products** to intrigue, help and inspire your customers.



Play

A dedicated version of the **Creative-Cables Configurator** for customers to use on wall-mounted touch screens, computers, tablets or smartphones, accompanied by a salesperson or on their own.

Customers create their custom-made lamp, while playing.



Touch

A **material library** (optional) organised in drawers for people to touch, check colour combinations and confirm choices.

The Configurator Corner makes selling custom products a **simple and automated process**.

No IT integration, no catalogues to learn or consult, no codes and prices to remember.

Hundreds of thousands of possible configurations **with no need to stock the product**.

The selection of configurable models can be customised to **match the offer of the point of sale**.

The customer retail price level is also fully configurable.



Who is it dedicated to?

Configurator Corner has been thought for a selected number of Point of sale.

- Lighting shops
- Furniture shops
- Concept Stores
- Home accessory shops
- Garden centres and outdoor furniture

How much space is required?

- From 0,5 to 10 square metres
- At least one free wall

How much investment does it require?

- Little, very little and in any case, it varies according to the individual project depending on the amount of material to be displayed, which device will be used for the configurator and the use of the material library.
- The installation and use of the configurator is completely **free of charge**.
- The design of the space is **handled by Creative-Cables**.



What do we offer?

- **Free of charge and customised design** of the display according to the needs and type of space.
- **Touch screen configurator**: the customer composes the lamp of their desire and receive it in the shop, with no stock commitment for the point of sale.
- **Material library**: a set of customised drawer units (optional) for the customer to “touch” the materials used in the configurator.
- An automatic order system to make the procurement process quick and easy.
- **Extra discounts** on the displayed products.
- Location on www.creative-cables.com as an **official Corner** where you can find Creative-Cables products.



DISPLAY SOLUTIONS

Eiva Mini Creative Box - Counter display unit

A tool that will make it easier for the customer to choose and for the retailer to sell. Despite its small size, the display unit contains all the components of our Eiva outdoor lighting system: the two Pastel or Elegant lines, the 8 silicone finishes available, the selection of Creative Cables cables for outdoor use and the innovative lamp holder patented by Creative Cables. The display unit is shipped pre-assembled, thereby avoiding the hassle of having to follow any assembly instructions. Just open the box to display it and start selling! Contact your local B2B sales team to find out how to get an EIVA Mini Creative Box with your next order.



MCB-EIVA
L 410mm, H 505mm, D 305mm



SCAESPEXP01
L 45cm, H 32cm, D 6cm

Cable Display Case

The eco-friendly leather suitcase for exhibiting the fabric cables samples of Creative-Cables. An elegant and practical way to present our vast range of colours and fabrics to your customers.

Each cable is labeled and can be extracted from the case: making it a useful helper when it comes to sales, but also an attractive piece to exhibit in your shop!

Counter-top or wall cable display

232 Textile cable colours displayed in colour scale in the space of one metre: thanks to this new display you will have a highly effective tool at your fingertips to help your customers find the right cable for their unique projects. Made of expanded pvc for resistance, the new display has a simple and elegant design and can be used as a stand or installed on the wall. Choose between the white or black version, both personalised with the Creative Cables logo. All samples are supplied with clearly legible labels to make it easier to identify the specific cable and place an order. The way the cable is inserted and extracted from its slot is even easier, thus extending the life of the individual samples.



○ KESPPNLBI
● KESPPNLNE

L 50cm, H 40cm, D 9/19cm



ESP8REEL
L 62cm, H 23cm, D 11cm

Reel Display Kit

The Reel Display Kit is a simple and elegant solution for displaying Creative-Cables cables on a wall. Each kit consists of 2 lateral leg loops with logo and 2 bars, to easily exhibit up to 8 reels of cable. The cable reels are not included, but are supplied by default with the purchase of 50 meters of lighting cable and 25 meters of cable for string lighting cables (or relative multiples).

CONTACT INFORMATION

Local contacts for B2C market

Creative-Cables Australia

1 Cairns st, Red Hill,
Brisbane
info.au@creative-cables.com
+61 (0) 733 67 26 64
www.creative-cables.com.au

Creative-Cables Austria

info.de@creative-cables.com
+49 681 95 26 40 34
www.creative-cables.at

Creative-Cables Belgium

Avenue Brugmann, 204
1050 Bruxelles
info.be@creative-cables.com
+32 02 732 82 32
www.creative-cables.be

Creative-Cables Colombia

Carrera 38 #10-57 Of. 203
Medellin 050021
info.co@creative-cables.com
+57/4 322 47 66
www.creative-cables.co

Creative-Cables Croatia

Nova cesta 109,
Zagreb
info.hr@creative-cables.com
+385 958 78 45 54
www.creative-cables.hr

Creative-Cables Czech Republic

Václavská 11/14,
603 00 Brno
info.cz@creative-cables.com
+420 776 39 74 72
www.creativecables.cz

Creative-Cables Denmark

AB Klasavägen 4,
432 95 Varberg
info.dk@creative-cables.com
+46 340 66 25 01
www.creative-cables.dk

Creative-Cables France

51 Rue de la République
13002 Marseille 2e Arrondissement
info.fr@creative-cables.com
+33 372 64 00 41
www.creative-cables.fr

Creative-Cables Germany

info.de@creative-cables.com
+49 681 95 26 40 34
www.creative-cables.de

Creative-Cables Greece

Pasalidi 24,
55134 Kalamaria Thessaloniki
info.gr@creative-cables.com
+30 231 05 31 938
www.creative-cables.gr

Creative-Cables Italy

Lungo Dora P Colletta n.113/9
10153 Torino
info.it@creative-cables.com
+39 800 03 41 80
www.creative-cables.it

Creative-Cables Nederland

Osloweg 1
9723 BE Groningen
info.nl@creative-cables.com
+31 (0)6 - 46 55 57 87
www.creative-cables.nl

Creative-Cables Portugal

Urb. Quinta das Palmeiras,
Lote 3, Loja D, 8400-623 Parchal
info.pt@creative-cables.com
+351 282 41 28 54
www.creative-cables.pt

Creative-Cables Reunion

38 rue Léon Lepervanche
97424 Piton Saint Leu
Reunion Island
info.re@creative-cables.com
+262 (0) 692 76 72 22
www.creative-cables.re

Creative-Cables Slovakia

Václavská 11/14,
603 00 Brno
info.sk@creative-cables.com
+420 776 39 74 72
www.creative-cables.sk

Creative-Cables Slovenia

Celovška cesta 172,
1000 Ljubljana
info.si@creative-cables.com
+386 (0) 516 06 252
www.creative-cables.si

Creative-Cables South Africa

Woodstock Exchange, 66 Albert Road,
Woodstock, Cape Town
info.za@creative-cables.com
+24 064 54 76 054
www.creative-cables.co.za

Creative-Cables Spain

Carrer dels Treballadors 1A,
46909 Torrent Valencia
info.es@creative-cables.com
+34 960 62 77 49
www.creative-cables.es

Creative-Cables Sweden

AB Klasavägen 4,
432 95 Varberg
info.se@creative-cables.com
+46 340 66 25 01
www.creative-cables.se

Creative-Cables Switzerland

Rue de Longschamps 2
2068 Hauterive NE
info.ch@creative-cables.com
+41 793 57 43 56
www.creative-cables.ch

Creative-Cables UK

Unit 57, Hillgrove Business Park,
Nazeing Road, Waltham Abbey,
Essex, EN9 2HB
info.uk@creative-cables.com
+44 (0) 203 94 01 748
www.creative-cables.co.uk

Creative-Cables Hungary

1094 Budapest, Tüzoltó utca 8
info.hu@creative-cables.com
+1 901 35 95 128

Creative-Cables USA

3043 Broad Avenue
TN 38112 Memphis
info.us@creative-cables.com
+1 901 35 95 128
www.creative-cables.us

INTERNATIONAL B2B

website: **b2b.creative-cables.com**
warehouse location: Lungo Dora P Colletta n.113/9
10153, Torino (TO) - Italia
email: info.b2b@creative-cables.com
tel: +39 011 24 78 463

Markets with local B2B operations

BENELUX

website: **b2b-benelux.creative-cables.com**
warehouse location: Belgium, Netherlands, Luxembourg
Nijverheidsstraat, 38
2570 - Duffel - Belgium
email: b2b.benelux@creative-cables.com
tel: +32 (0) 349 24 40

GERMANY

website: **b2b.creative-cables.com**
warehouse location: Lungo Dora P Colletta n.113/9
10153, Torino (TO) - Italia
email: b2b.de@creative-cables.com
tel: +49 681 95 26 40 33

NORDIC SWEDEN & DENMARK

website: **b2bnordic.creative-cables.com**
warehouse location: AB Klasavägen 4,
432 95 Varberg
email: b2bnordic@creative-cables.com
tel: +46 340 66 25 01

UNITED KINGDOM

website: **b2b.creative-cables.co.uk**
warehouse location: Unit 57, Hillgrove Business Park,
Nazeing Road, Waltham Abbey,
Essex, EN9 2HB
email: b2b.uk@creative-cables.com
tel: +44 (0) 203 94 01 748

FRANCE

website: **b2b.creative-cables.com**
warehouse location: Lungo Dora P Colletta n.113/9
10153, Torino (TO) - Italia
email: cristina.mancuso@creative-cables.com
tel: +33 372 64 00 38

ITALY

website: **b2b.creative-cables.it**
warehouse location: Lungo Dora P Colletta n.113/9
10153, Torino (TO) - Italia
email: b2b.it@creative-cables.com
tel: +39 011 24 95 093

SPAIN

website: **b2b.creative-cables.es**
warehouse location: Carrer dels Treballadors, 1 A
46909 Torrent Valencia
email: b2b.es@creative-cables.com
tel: +34 960 62 77 69

USA

website: **www.creative-cables.us**
warehouse location: 3043 Broad Avenue
Memphis, TN 38112
email: info.us@creative-cables.com
tel: +1 901 35 95 128



Creative-Cables Stores

Creative-Cables Store Brescia

Corso Martiri della Libertà 58,
Brescia
storebrescia@creative-cables.com
+39 030-6392917

Creative-Cables Store Milano

Via Edmondo De Amicis 50,
Milano
+39 02-38317349
storemilano@creative-cables.com

Creative-Cables Store Roma

Via Alessandria 100,
Roma
+39 06-92594377
storeroma@creative-cables.com

Creative-Cables Store Torino

Via Giuseppe Mazzini 24D,
Torino
+39 011-8397816
negoziotorino@creative-cables.com

Creative-Cables Store Treviso

Viale Montegrappa 58,
Treviso
+39 0422-1723878
storetreviso@creative-cables.com

Creative-Cables Store Green Pea

Via Nizza 230,
Torino
+39 011-6640107

Creative-Cables Store Parma

Borgo Gian Domenico Romagnosi 8,
Parma
+39 05-211680531
storeparma@creative-cables.com

Creative-Cables Store Bruxelles

Rue de Stalle 288 A, 1180 Uccle,
Belgio
+32-27328232

Creative-Cables Store CapeTown

c/o Woodstock Exchange, 66 Albert
Rd, Woodstock, Cape Town, 7925,
South Africa
+27 64 547 6054

Creative-Cables Store Memphis

3043 Broad Ave, Memphis, TN 38112,
Stati Uniti
+1-901-359-5128

Creative-Cables Store Tenerife

AV. Familia Betancourt Y Molina, 11
38400 Puerto de la Cruz
+34-922195901
storetenerife@creative-cables.com

Creative-Cables Store Zagabria

Nova Cesta 109
10000 Zagabria
+385 95 396 8385
storezagreb@creative-cables.com

CA Store Monaco di Baviera

Viktualienmarkt, 15
storemuenchen@creative-cables.com

Creative-Cables Store Marsiglia

51 Rue de la République
13002 Marseille, Francia
storemarseille@creative-cables.com

COPYRIGHT BY CREATIVE-CABLES S.P.A.
IT IS FORBIDDEN TO COPY THE CATALOGUE, EVEN PARTIALLY.

In the ongoing search for technical and functional improvements,
Creative-Cables reserves the right to make changes, substantial
or not, to its products, which may be put into effect without prior
notice.

The images and the colours are provided for general information
purposes only and are not binding for Creative-Cables.

Creative-Cables
Lungo Dora Pietro Colletta 113/9
10153, Turin (TO) - Italy
VAT number: IT09813270015
www.creative-cables.com
For Enquiries: +39 011-835037
info.b2b@creative-cables.com