

LUXIFER  
LIGHTING SOLUTIONS



KATALOG SVÍTIDEL 2017

## *Luxifer CZ s.r.o.*

adresa: Škrétova 4, Praha 2, 120 00  
telefon: +420 773 592 099  
email: [info@luxifer.cz](mailto:info@luxifer.cz)

[www.luxifer.cz](http://www.luxifer.cz)



LED DEKORATIVNÍ SVĚTLA  
STRANA 19-36



LED NÁSTĚNNÁ SVÍTIDLA  
STRANA 37-69



LED ZÁPUSTNÁ NÁSTĚNNÁ SVÍTIDLA  
STRANA 70-79



LED OSVĚTLENÍ,  
LOŽNIC A KOUPELNY  
STRANA 80-118



LED ZÁVĚSNÁ SVÍTIDLA  
STRANA 119-203



LED STROPNÍ SVÍTIDLA  
STRANA 204-241



LUSTRY  
STRANA 242-261



LED POVRCHOVÁ BODOVÁ SVÍTIDLA  
STRANA 262-281



LED KOLEJNICOVÝ SYSTÉM  
STRANA 282-309



LED PANELY  
STRANA 310-323



LED ZÁPUSTNÁ BODOVÁ SVĚTLA  
STRANA 324-367



MODULÁRNÍ SYSTÉMY  
STRANA 368-383



STROPNÍ SVÍTIDLA  
STRANA 384-399



STOLNÍ A STOJACÍ LAMPY  
STRANA 400-405



LED OSVĚTLENÍ VYTRÍN  
STRANA 406-409



LED EXTERIÉROVÁ SVÍTIDLA  
STRANA 410-447

LED  
DEKORATIVNÍ  
SVÍTIDLA

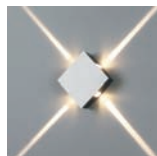

LWA161 P2



LWA158 P3



LWA159 P4



LWA60 P4



LWA156 P5

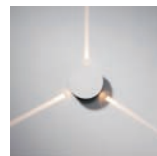

LWA157 P5



LWA166 P6

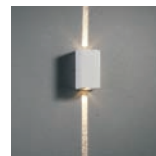

LWA167 P7

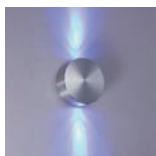

LWA027 P9



LWA028 P9



LWA029 P9



HL025/1 P10

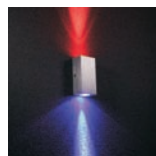

HL025/2 P11

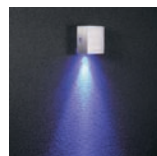

LWA071 P12



LWA072 P12

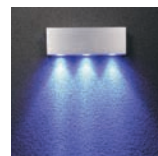

LWA073 P12



LDC909 P14



LDC908 P15

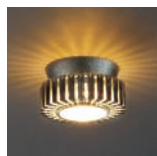

HL8022L P16

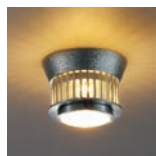

HL8004L P17



LED  
NÁSTĚNNÁ  
SVÍTIDLA

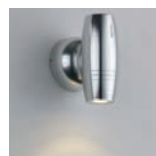

LWA051 P19

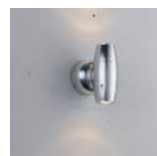

LWA052 P19

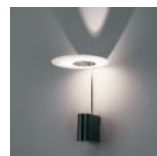

LWA106 P20

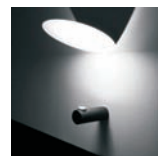

LWA138 P21



LWA183 P22



LWA182 P23



LWA184 P24



LWA185 P25

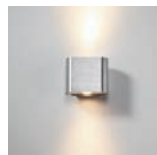

LWA101 P26



LWA103 P26



LWA105 P26

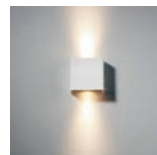

LWA022 P27

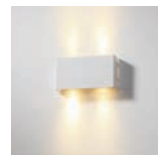

LWA024 P27



LWA026 P27



HL004/1 P28



HL004/2 P31

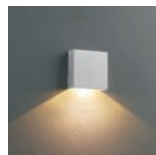

LWA164 P32



LWA165 P33

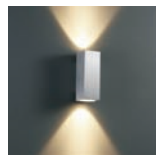

LWA117 P34

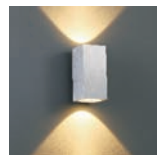

LWA119 P35

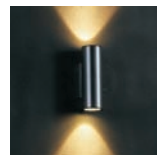

LWA116 P36

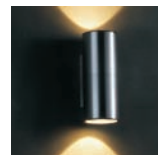

LWA118 P36



LWA115 P38



HL8072/1 P39

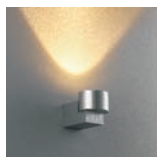

LWA134 P40



LWA149-WT P41



LWA150-WT P41

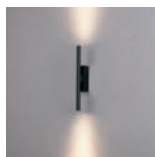

LWA226 P42

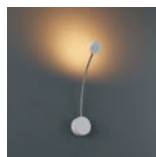

LWA137 P42

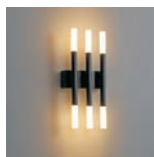

LWA241 P43

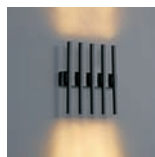

LWA240 P43

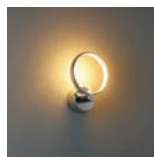

LWA223 P44

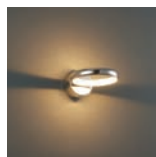

LWA222 P44



LWA141 P45



LWA142 P45

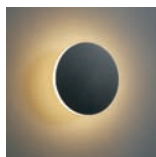

LWA228A-BK P46

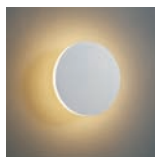

LWA228A-WT P46

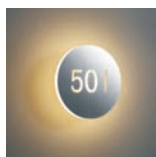

LWA228B P47

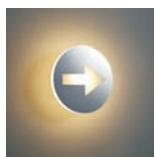

LWA228C P47

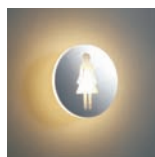

LWA228E P47

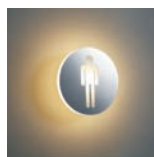

LWA228D P47

LED  
ZÁPUSŤNÁ  
NÁSTĚNNÁ  
SVÍTIDLA

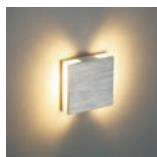

LSL003 P50

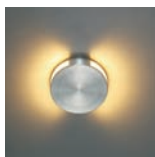

LSL004 P50

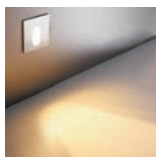

LSL001 P51

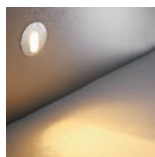

LSL002 P51

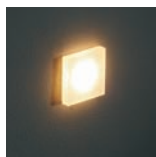

LSL008 P52

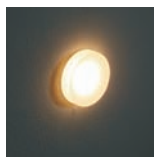

LSL009 P52

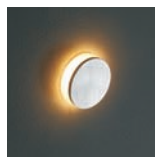

LSL009A P53



LSL008A P53

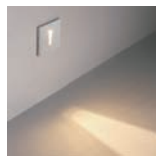

LSL013 P54

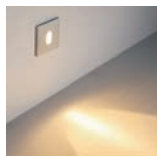

LSL011 P54

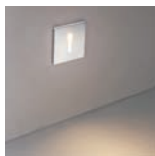

LSL013A P55

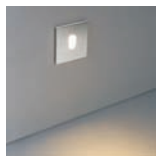

LSL011A P55

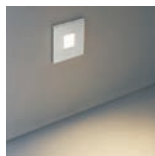

LSL012A P55

LED  
OSVĚTLENÍ  
LOŽNIC A  
KOUPELEN



LWA067 P60



LWA070B P60



LWA070 P61



LWA061 P61



LWA067B P62



LWA187 P62



LWA187 P63

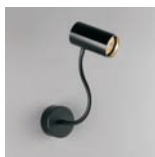

LWA188 P63



HL8019A P64



HL9003/1 P64



HL8019B P64



LWA220A P65



LWA225 P65



LWA219-WT P66



LWA220-WT P66



LWA219-CR P67



LWA220-CR P67



LWA219-SL P68



LWA220-SL P68



LWA219-BK P69



LWA220-BK P69



LWA203 P72



LWA204 P72



LWA205 P73



LWA206 P73



LWA189 P76



LWA190 P76



LWA191 P77



LWA192 P77



LWA192 P78

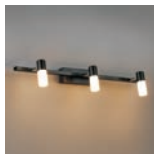

LWA194 P78



LWA195 P79



LWA196 P79



LWA235 P80



LWA236 P80



LWA237 P81



LWA238 P81

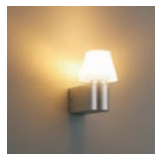

LWA207A P84

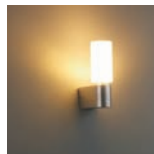

LWA208A P84

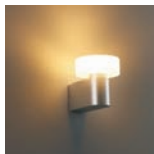

LWA209A P84

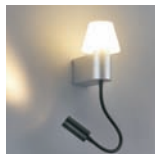

LWA207B P85

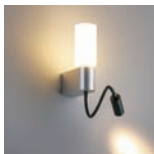

LWA208B P85

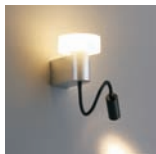

LWA209B P85



LWA149-SL P86



LWA150-SL P86



LWA151-SL P87



LWA200-WT P89



LWA200-BK P89

LED  
ZÁVĚSNÁ  
SVÍTIDLA



HL012-BK P92



HL012-WT P92



LPL045-BK P95



LPL045-WT P95



LPL149 P96



LPL150 P96



LPL151 P96



LPL118 P98



LPL002 P100



LPL043 P102



LPL042 P102



LPL119 P103



LPL120 P103



LPL046SQ P106



LPL011 P107



LPL012 P107



LPL013 P107



LPL147 P109



LPL148 P109



LPL139-BK P110



LPL139-WT P110



LPL140-BK P111



LPL140-WT P111



LPL190 P112



LPL191 P112



LPL185 P113



LPL186 P113



LPL159-SL P114



LPL160-SL P116



LPL161-SL P116



LPL142 P120



LPL211 P122



LPL210 P123



LPL215 P124



LPL216 P124



LPL217 P124



LPL206-BK P125



LPL206-WT P125



LPL206-CR P125



LPL162 P126



LPL163 P126



LPL164 P126



LPL222 P127



LPL223 P127



LPL221 P127



LPL301 P132



LPL302-WT P133



LPL302-BK P133



LPL302-RD P134



LPL302-YW P134



LPL302-GN P134



LPL152-BK P138



LPL152-WT P138



LPL153-BK P138



LPL153-WT P138



LPL155-BK P138



LPL155-WT P138



LPL154-WT P138



LPL176 P140



LPL177 P140



LPL174 P143



LPL175 P143



LPL236 P144



LPL237 P144



LPL238 P144



LPL239 P145



LPL156 P148



LPL157 P148



LPL187 P149



LPL188 P149



LPL202 P150



LPL203 P150



LPL204 P151



LPL205 P151



LPL194 P152



LPL193 P153



LPL195 P153



LPL201-BK P154



LPL201-WT P154

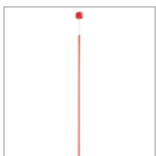

LPL201-RD P154



LPL196 P156



LPL197 P156



LPL251 P157



LPL243 P164



LPL244 P165



LPL214-BK P158

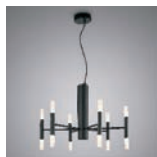

LPL212-BK P161



LPL213-BK P161

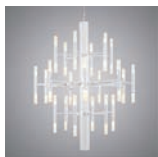

LPL214-WT P162



LPL212-WT P163

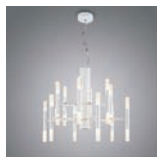

LPL213-WT P163



LPL245 P168



LPL246 P169



LED  
STROPNÍ  
SVÍTIDLA



LBL104 P172



LBL105 P172



LBL106 P172



LBL135 P1174



LBL136 P174



LBL137 P174



LBL207 P175



LBL208 P175



LBL209 P175



LBL201-WT P176



LBL202-WT P176



LBL203-WT P176



LBL204-WT P177



LBL205-WT P177



LBL206-WT P177



LBL204-BK P179



LBL205-BK P179



LBL206-BK P179



LBL202-BK P178



LBL203-BK P178



LBL083 P181



LBL084 P181



LBL048-WT P182



LBL048-BK P182



LBL112 P183



LBL118 P184



LBL119 P184



LBL120 P184

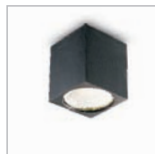

LBL111-BK P186



LBL111-SL P186



LBL110-WT P186



LBL173 P187



LBL174 P187



LBL175 P187



LBL049 P190



LBL054 P190



LDC013 P190



LBL057 P191



LBL050 P191



LBL602 P191



LBL052 P193



LBL053 P193



LBL001 P194



LBL002 P194



LBL003 P194



LBL031 P194



LBL032 P194



LBL033 P194



LBL074-BK P197



LBL074-WT P197



LBL075-BK P197



LBL075-WT P197



LBL108-2 P198



LBL108-3 P198



LBL108-5-SL P199



LBL115-WT P200



LBL115-SL P200



LBL116-WT P201



LBL117 P204



LBL096 P205



LBL095 P205



LBL099 P205



LBL098 P205



LBL162-BK P206



LBL162-WT P206



LBL172-BK P207



LBL172-SL P207

LED  
ZÁVĚSNÁ



LBL143 P210



LBL169 P213



LBL139 P214



LBL140 P214



LBL167 P216



LBL168 P216



LBL171 P217



LBL170 P217



LBL158 P218



LBL159 P218



LBL160 P219



LBL161 P219



LBL151 P220



LBL152 P220



LBL150 P221



LBL153 P221



LBL146 P222



LBL147 P222



LBL148 P223



LBL149 P223



LBL155 P224



LBL156 P224



LBL154 P225



LBL157 P225

LED  
BODOVÁ  
SVÍTIDLA



H8107 P228



LBL134 P228



HLSP001 P229



LSP9011 P229



LBL132 P229



LBL080 P230



LBL081 P230



LBL082 P230



LBL146 P222



LBL146 P222



LBL077 P232



LBL078 P232



LBL079 P232



LSP071 P235



LSP072 P235



LSP073 P235



HL8088-BK P236



HL8088-SL P236



LBL121 P237



LBL122 P237



LBL125 P238



LBL126 P238



LBL128 P238



LBL129 P239



LBL130 P239



LBL123 P240



LBL051 P240



LSP159 P241

LED  
KOLEJNICOVÝ  
SYSTÉM



LSP104 P244



LSP105 P244



LSP103 P244



LSP146 P245



LSP147 P245



LSP151 P246



LSP152 P246



LSP106 P248



LSP108 P248



LSP110 P248



LSP111 P249



LSP112 P249



LSP113 P249



LSP134 P250



LSP135 P250



LSP114 P251



LSP125 P251



LSP115 P254



LSP118 P254

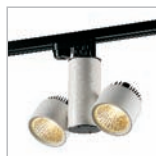

LSP119 P255



LSP120 P254



LSP121 P255



LSP123 P256



LSP124 P256



LSP117 P257



LSP122 P257



LSP202 P260



LSP204 P260



LSP201 P261



LSP203 P261



LSP206 P264



LSP205 P264



LSP208 P265



LSP207 P265



TR-LPL155-WT  
P266



TR-LPL155-BK  
P266



TR-LPL174  
P267



TR-LPL176  
P267



TR-HL012-BK  
P268



TR-HL012-WT  
P268



TR-LPL045-BK  
P268



TR-LPL045-WT  
P268



TR-LPL202  
P269



TR-LPL187  
P269

LED  
PANELY



LQL001-BK P272



LQL001-WT P273



LQL001-SL P273



LQL002-BK P275



LQL002-WT P275



LQL002-SL P275



LQL004-SL P276



LQL003-SL P277

LED  
ZÁPUSTNÁ  
BODOVÁ  
SVĚTLA



LDC880-BK P283



LDC880-WT P283



LDC880-SL P283



LDC880-RD P283



LDC880-CR P283



LDC880-GD P283



LDC880A P290



LDC880B P290

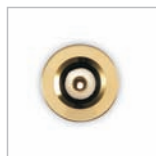

LDC880A-GD P290



LDC880A-BK P290



LDC880A-SL P290

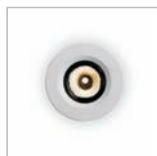

LDC880A-WT P290



LDC880B-GD P290



LDC880B-BK P290



LDC880B-SL P290



LDC880B-WT P290



LDC005A-GD P290



LDC005A-BK P290



LDC005A-SL P290

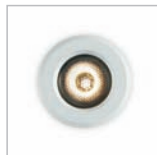

LDC005A-WT P290



LDC006A-GD P290



LDC006A-BK P290



LDC006A-SL P290



LDC006A-WT P290



LDC001A-GD P293



LDC001A-BK P293



LDC001A-SL P293



LDC001A-WT P293



LDC898 P294



LDC899 P294



LDC900 P294



LDC901 P294



LDC902 P294



LDC903 P294



LDC904 P294



LDC905 P294



LDC906 P294



LDC801 P296



LDC301 P296



LDC028 P296



LDC935A P297



LDC936A P297



LDC938A P297



LDC926-WT P298



LDC927-WT P298



LDC928-WT P298



LDC926-SL P299



LDC927-SL P299



LDC928-SL P299



LDC979B P300



LDC978B P300



LDC979A P301



LDC978A P301



LDC969 P302



LDC970 P302



LDC984 P303



LDC985 P303



LDC988-BK P305



LDC989-BK P305



LDC990-BK P305



LDC991-BK P305



LDC988-WT P306



LDC989-WT P306



LDC990-WT P306



LDC991-WT P306



LDC988-GD P307



LDC989-GD P307



LDC990-GD P307



LDC991-GD P307



CSL001 P309



CSL002 P309



CSL003 P309



CSL005-CR P310



CSL005-BK P310



CSL005-RU P310



CSL005-RT P310



CSL009-BK P311



CSL009-RU P311



CSL009-RT P311



CSL007-SM P312



CSL008-SM P312



CSL007-BG P313



CSL008-BG P313



CSL006-SM P314



CSL006-BG P314



CSL011-SM P315



CSL011-BG P315



CDL001 P316



CDL002 P316



CDL003 P316



CDL004 P316

LED  
ZÁPUSTNÁ  
BODOVÁ  
SVĚTLA  
NASTAVITELNÁ



LDC889 P320



LDC890 P320



LDC891 P320



LDC892 P321



LDC893 P321



LDC923 P322



LDC924 P322



LDC925 P322



LDC955 P324



LDC956 P324



LDC957 P324



LDC958 P325



LDC959 P325



LDC960 P325



LDC961 P327



LDC962 P327



LDC963 P327



LDC940 P329



LDC941 P329



LDC942 P329



LDC952 P330



LDC953 P330



LDC954 P330

LED  
ZÁPUSTNÁ  
BODOVÁ  
SVÍTIDLA



LDC858A P337



LDC859A P337



LDC860A P337



LDC861A P337



LDC862A P337



LDC863A P337



LDC858B P337



LDC859B P337



LDC860B P337



LDC861B P337



LDC862B P337



LDC863B P337



LDC931A-SL P338



LDC932A-SL P338



LDC934A-SL P338



LDC931A-GD P339



LDC932A-GD P339



LDC34A-GD P339



LDC931A-WT P340



LDC932A-WT P340



LDC34A-WT P340



LDC964-WT P342



LDC965-WT P342



LDC966-WT P342



LDC967-WT P342



LDC310 P344



LDC311 P344



LDC312 P344



LDC313 P344



LDC967-WT P342



LDC967-WT P342



LDC967-WT P342



LDC858C P347



LDC859C P347



LDC860C P347



LDC861C P347



LDC862C P347



LDC863C P347



STOLNÍ A  
STOJACÍ  
LAMPY



LTL014-BK P349



LTL016-BK P350



LTL016-WT P350



LFL019-WT P353



LFL019-BK P353

LED  
OBCHODNÍ  
OSVĚTLENÍ



LSD016 P355



LSD017 P355



LSD018 P355



LSD013-CR P356



LDC014-CR P356



LDC013-BK P357



LDC014-BK P357

LED  
EXTERIÉROVÉ  
OSVĚTLENÍ

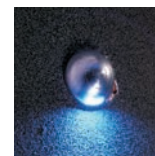

ODL007 P368



ODL008 P368

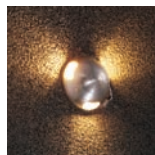

ODL009 P368

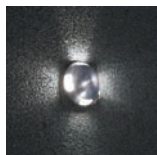

ODL010 P368

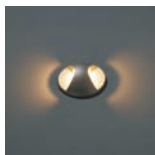

ODL025 P369

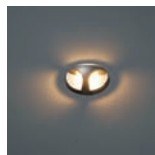

ODL026 P369

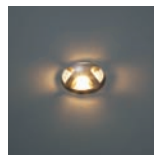

ODL027 P369

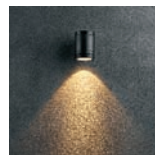

LWA173A P370

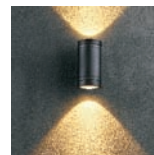

LWA174A P370

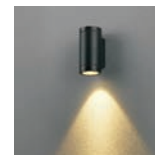

LWA215 P372

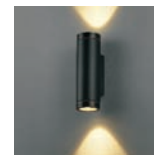

LWA216 P372

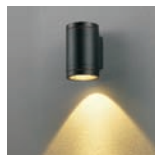

LWA217 P373

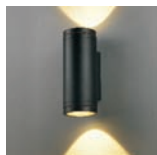

LWA218 P373



LWA135 P374

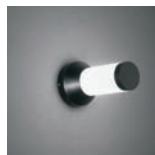

LWA139 P375

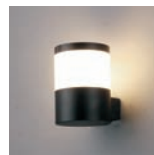

LWA214 P376

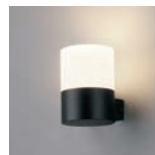

LWA213 P376



LWA210 P377

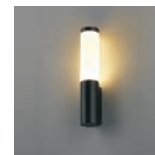

LWA211 P377

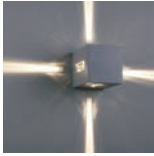

LWA401 P378



LWA402 P378

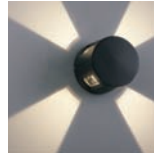

LWA403 P379

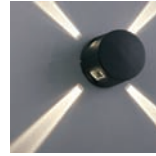

LWA404 P379



ODL020 P382



ODL024 P382



ODL001 P382



ODL031 P384



ODL032 P384



ODL033 P384



ODL028 P385



ODL029 P385



ODL030 P385



ODL035 P386



ODL036 P386



LSP155 P387



LSP156 P387



LSP157 P387



LFL009 P388



LFL010 P388



LFL011 P388



LFL006 P389



LFL007 P389



LFL008 P389



LFL013 P392



LFL014 P392



LFL015 P392



LFL016 P393



LFL017 P393



LFL018 P393

# LED DEKORATIVNÍ OSVĚTLENÍ

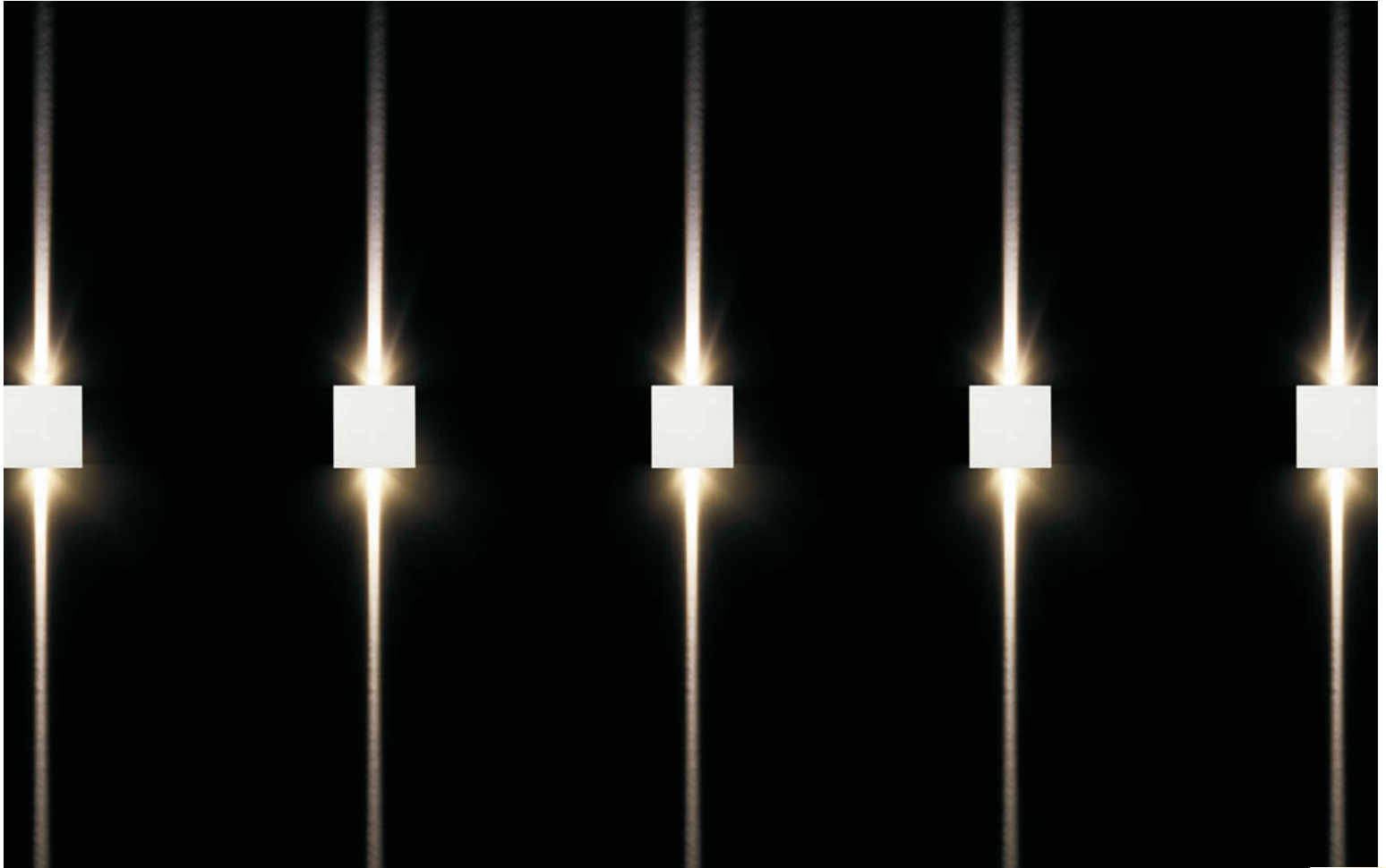

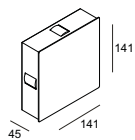
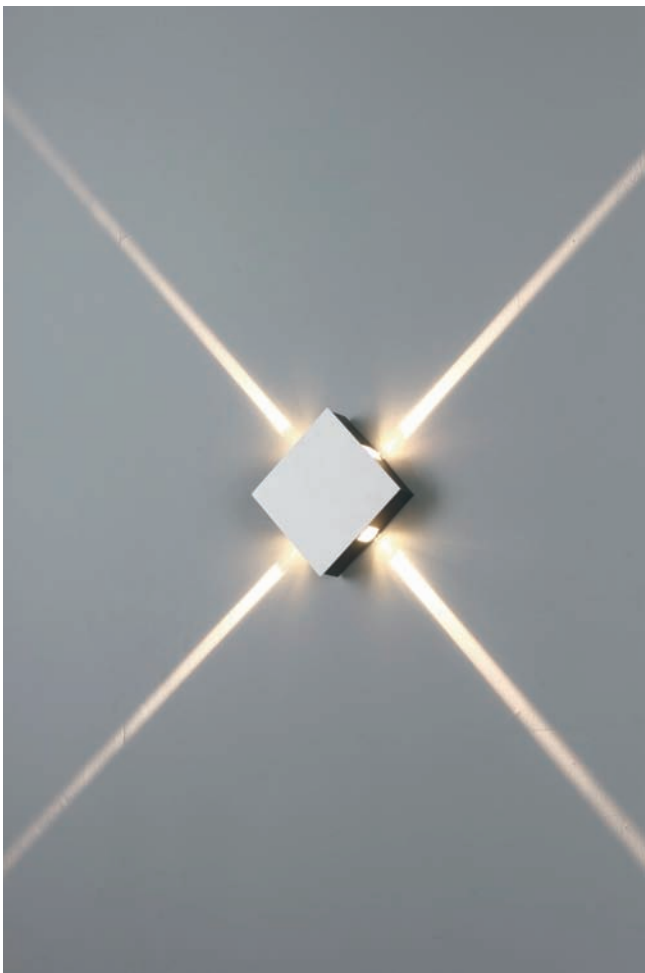

● LWA161

materiál: matná ocel  
CREE LED 4X1W / WW  
Ra85 / 400lm  
obsahuje zdroj  
IP20 / class I / **CE**  
bílá  
3000K/4000K/6000K



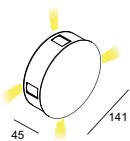



● LWA158

materiál: matná ocel  
CREE LED 4X1W / WW  
Ra85 / 400lm  
obsahuje zdroj  
IP20 / class I / CE  
bílá  
3000K/4000K/6000K

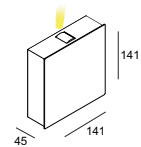



● LWA159

materiál: matná ocel  
 CREE LED 1X1W / WW  
 Ra85 / 100lm  
 obsahuje zdroj  
 IP20 / class I /    
 bílá  
 3000K/4000K/6000K

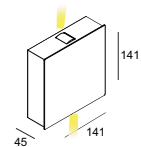

● LWA160

materiál: matná ocel  
 CREE LED 2X1W / WW  
 Ra85 / 200lm  
 obsahuje zdroj  
 IP20 / class I    
 bílá  
 3000K/4000K/6000K /

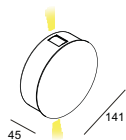
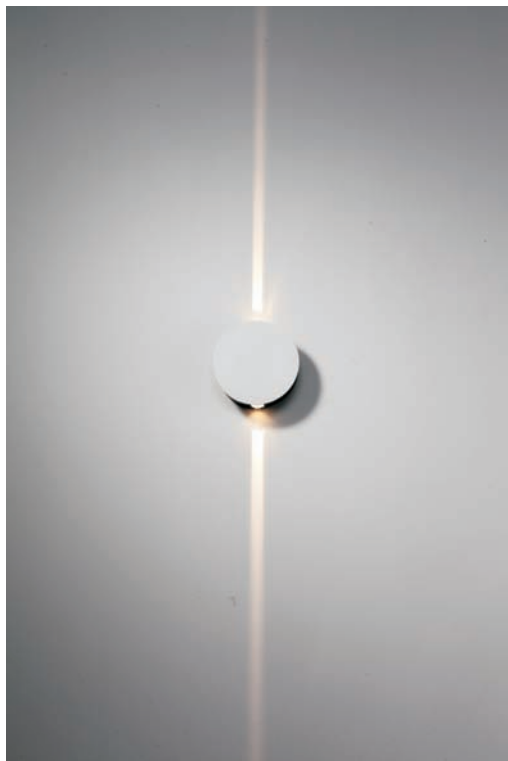

● LWA156

materiál: matná ocel  
CREE LED 2X1W / WW  
Ra85 / 200lm  
obsahuje zdroj  
IP20 / class I /   
bílá  
3000K/4000K/6000K

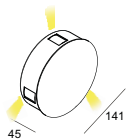

● LWA157

materiál: matná ocel  
CREE LED 3X1W / WW  
Ra85 / 300lm  
obsahuje zdroj  
IP20 / class I /   
bílá  
3000K/4000K/6000K

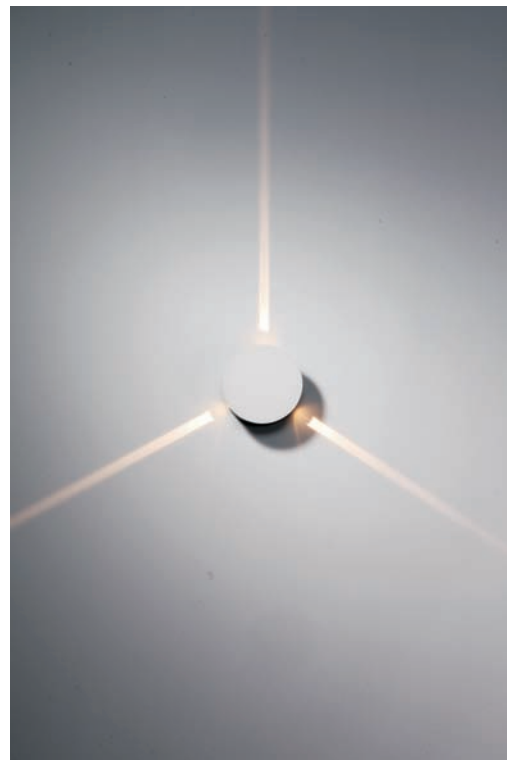



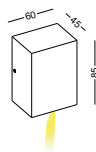

● LWA166

materiál:hliník  
CREE LED 1X1W / WW  
Ra85 / 100lm  
obsahuje zdroj  
IP20 / class I /   
bílá  
3000K/4000K/6000K

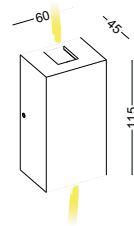
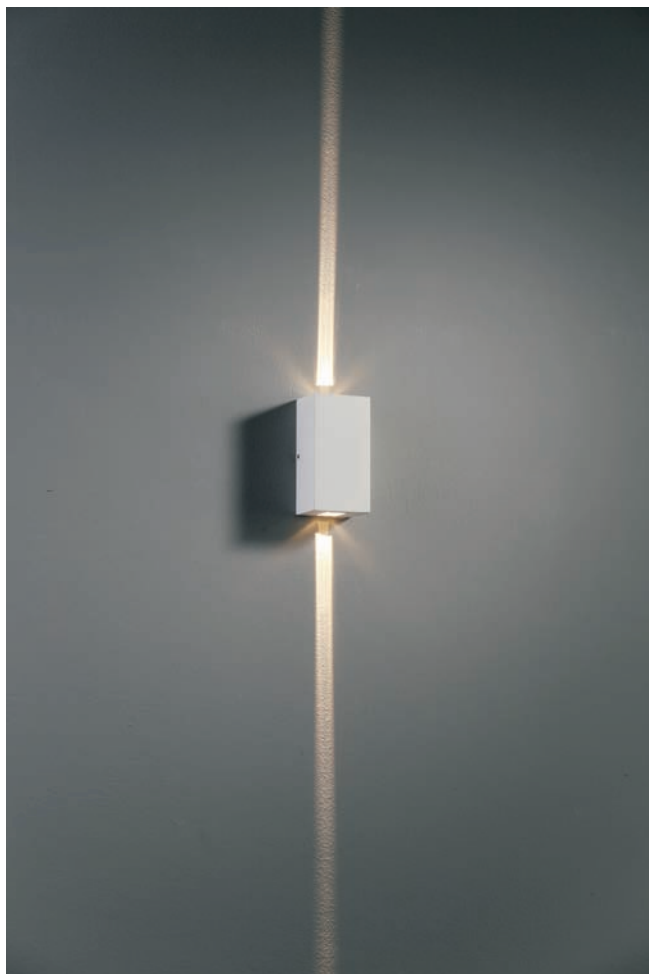

● LWA167

materiál:hlinik  
CREE LED 2X1W / WW  
Ra85 / 200lm  
obsahuje zdroj  
IP20 / class I / **CE**  
bilá  
3000K/4000K/6000K

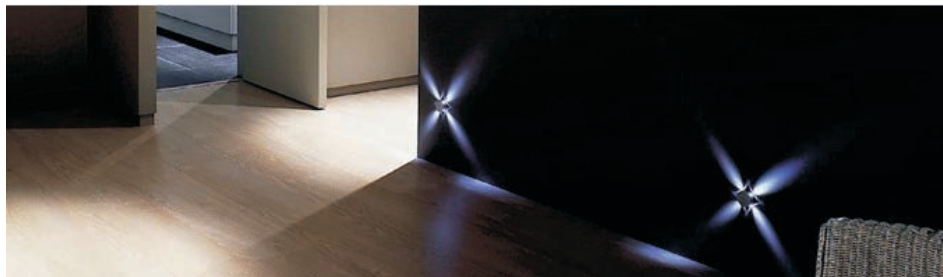
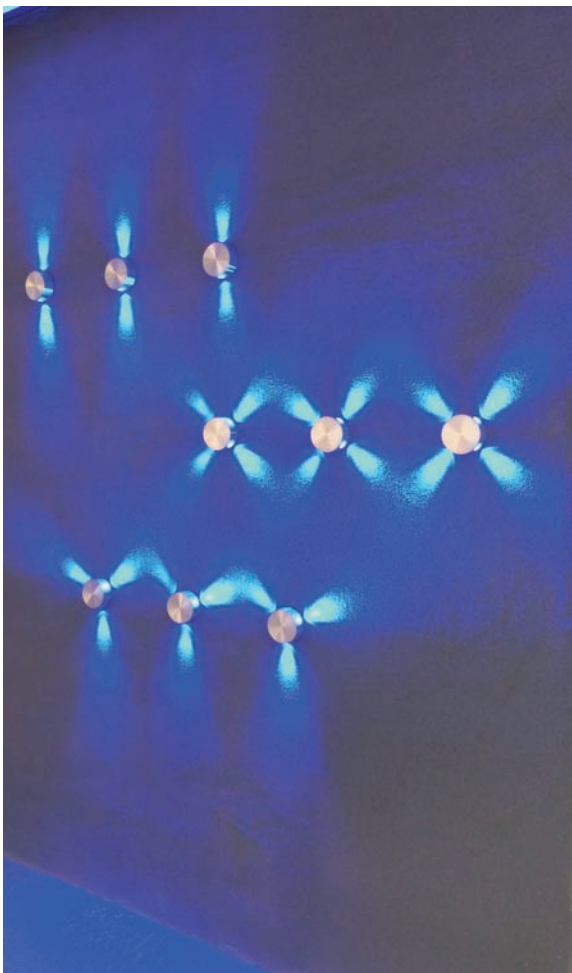

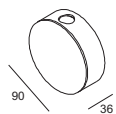

● **LWA027**  
 materiál:hliník  
 LED 2X1W / WW  
 Ra80 / 200lm/10°  
 obsahuje zdroj  
 IP20 / class I / **CE**  
 broušená stříbrná  
 3000K/4000K/6000K

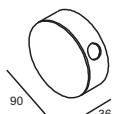

● **LWA028**  
 materiál:hliník  
 LED 3X1W / WW  
 Ra80 / 300lm/10°  
 obsahuje zdroj  
 IP20 / class I / **CE**  
 broušená stříbrná  
 3000K/4000K/6000K

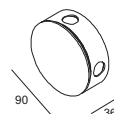

● **LWA029**  
 materiál:hliník  
 LED 4X1W / WW  
 Ra80 / 400lm/10°  
 obsahuje zdroj  
 IP20 / class I / **CE**  
 broušená stříbrná  
 3000K/4000K/6000K



● HL025/1

materiál:hliník  
LED 1W / WW  
Ra80 / 100lm/10°  
obsahuje zdroj  
IP20 / class II /   
broušená stříbrná  
3000K/4000K/6000K

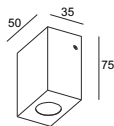



● HL025/2

materiál: hliník  
LED 2X1W / WW  
Ra80 / 200lm/1Ů  
obsahuje zdroj  
IP20 / class II / **CE**  
broušená stříbrná  
3000K/4000K/6000K

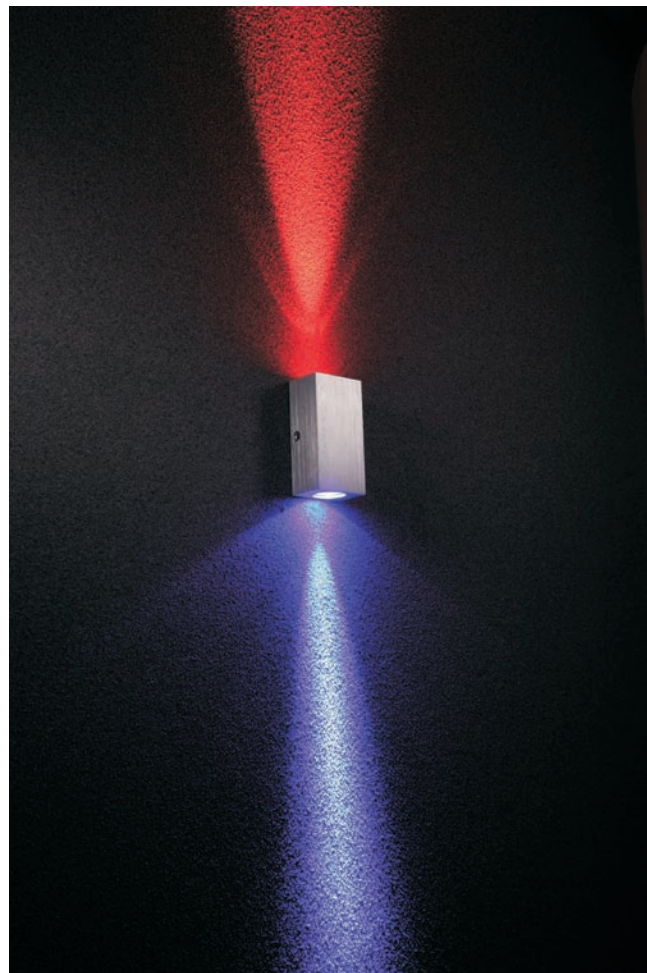
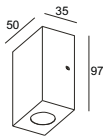

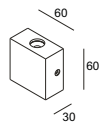
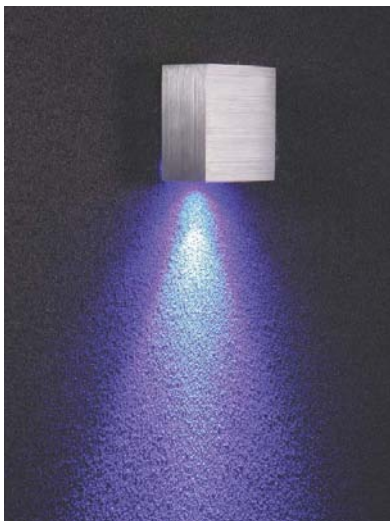

● LWA071

materiál: hliník  
LED 1X1W / WW  
Ra80 / 100lm/30°  
obsahuje zdroj  
IP20 / class II /CE  
broušená stříbrná  
3000K/4000K/6000K

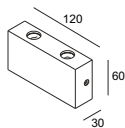

● LWA072

materiál: hliník  
LED 2X1W / WW  
Ra80 / 200lm/30°  
obsahuje zdroj  
IP20 / class II /CE  
broušená stříbrná  
3000K/4000K/6000K

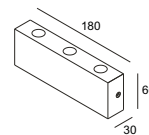

● LWA073

materiál: hliník  
LED 3X1W / WW  
Ra80 / 300lm/30°  
obsahuje zdroj  
IP20 / class II /CE  
broušená stříbrná  
3000K/4000K/6000K





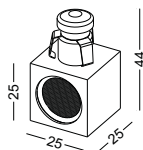

● LDC908

materiál: hliník  
 CREE LED 1X1W / WW  
 Ra85 / 100lm/3đ  
 bez zdroje  
 IP20 / class III / **CE**  
 výřez dia20mm  
 povrchová úprava:  
 bílá/broušená stříbrná  
 3000K/4000K/6000K

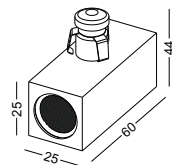

● LDC909

materiál: hliník  
 CREE LED 2X1W / WW  
 Ra85 / 200lm/3đ  
 bez zdroje  
 IP20 / class III / **CE**  
 výřez dia20mm  
 povrchová úprava:  
 bílá/broušená stříbrná  
 3000K/4000K/6000K





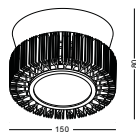

● HL8022L

materiál: hliník  
COB LED 5W / WW  
Ra85 / 500lm  
obsahuje zdroj  
IP20 / class I / **CE**  
stříbrná  
3000K/4000K/6000K  
průměr140mm V75mm

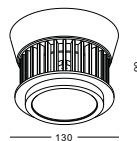

● HL8004L

materiál: hliník  
COB LED 5W / WW  
Ra85 / 500lm  
obsahuje zdroj  
IP20 / class I / **CE**  
stříbrná  
3000K/4000K/6000K  
průměr130mm V90mm





# LED NÁSTĚNNÉ OSVĚTLENÍ

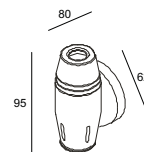
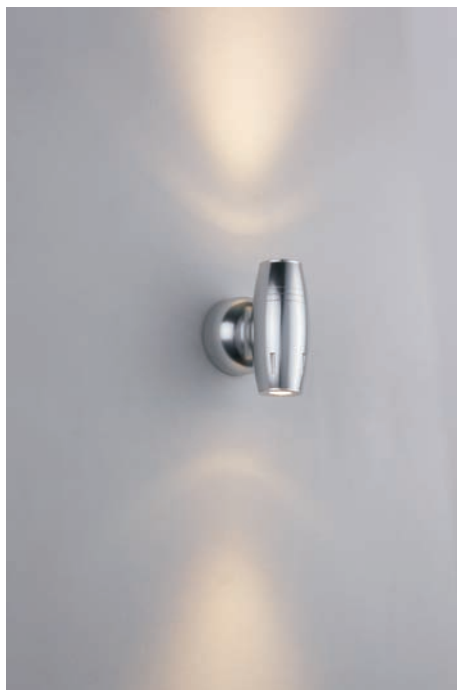

#### ● LWA051

materiál: hliník  
LED 1X1W / WW  
Ra80 / 100lm/30°  
obsahuje zdroj  
IP20 / class I   
stříbrná  
3000K/4000K/6000K

#### ● LWA052

materiál: hliník  
LED 2X1W / WW  
Ra80 / 200lm/30°  
obsahuje zdroj  
IP20 / class I   
stříbrná  
3000K/4000K/6000K

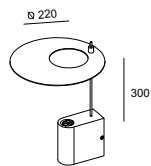

● LWA106

materiál: hliník

CREE LED 3X1W / WW

Ra85 / 366lm

obsahuje zdroj

IP20 / class I / **CE**

broušená černá a bílé stínítko

3000K/4000K/6000K



● LWA138

materiál: hliník  
CREE LED 6X1W / WW  
Ra90 / 732 lm  
obsahuje zdroj  
IP20 / class I / CE  
černá a bílé stínítko  
3000K/4000K/6000K



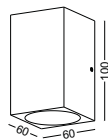

● LWA183

materiál: hliník  
 CREE LED 2X1W / WW  
 Ra85 / 244lm  
 obsahuje zdroj  
 IP20 / class I / **CE**  
 broušená stříbrná  
 3000K/4000K/6000K



● LWA182

materiál: hliník  
CREE LED 1X3W / WW  
Ra85 / 340lm  
obsahuje zdroj  
IP20 / class I /   
broušená stříbrná  
3000K/4000K/6000K

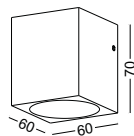

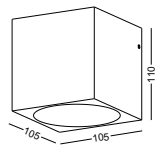

● LWA184

materiál: hliník  
COB LED 5W / WW  
Ra85 / 500lm  
obsahuje zdroj  
IP20 / class I / **CE**  
broušená stříbrná  
3000K/4000K/6000K

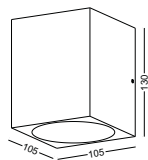

● LWA185

materiál: hliník  
COB LED 2X5W / WW  
Ra85 / 1000lm  
obsahuje zdroj  
IP20 / class I /   
broušená stříbrná  
3000K/4000K/6000K



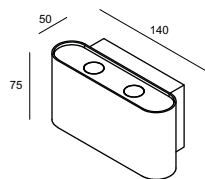

● LWA103

materiál: hliník  
LED 4X1W / WW  
Ra80 / 400lm/30°  
obsahuje zdroj  
IP20 / class I / **CE**  
broušená stříbrná

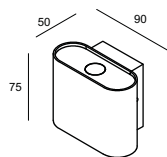

● LWA107

materiál: hliník  
LED 2X1W / WW  
Ra80 / 200lm/30°  
obsahuje zdroj  
IP20 / class I / **CE**  
broušená stříbrná

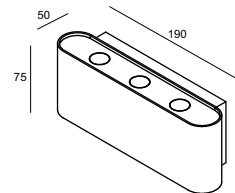

● LWA105

materiál: hliník  
LED 6X1W / WW  
Ra80 / 600lm/30°  
obsahuje zdroj  
IP20 / class I / **CE**  
broušená stříbrná

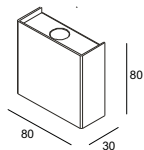

● LWA022

materiál: hliník  
LED 2X1W / WW  
Ra80 / 200lm/30°  
obsahuje zdroj  
IP20 / class I / **CE**  
biela

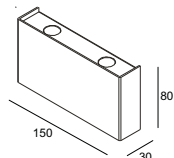

● LWA024

materiál: hliník  
LED 4X1W / WW  
Ra80 / 400lm/30°  
obsahuje zdroj  
IP20 / class I / **CE**  
biela

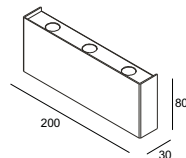

● LWA026

materiál: hliník  
LED 6X1W / WW  
Ra80 / 600lm/30°  
obsahuje zdroj  
IP20 / class I / **CE**  
biela



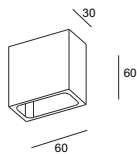
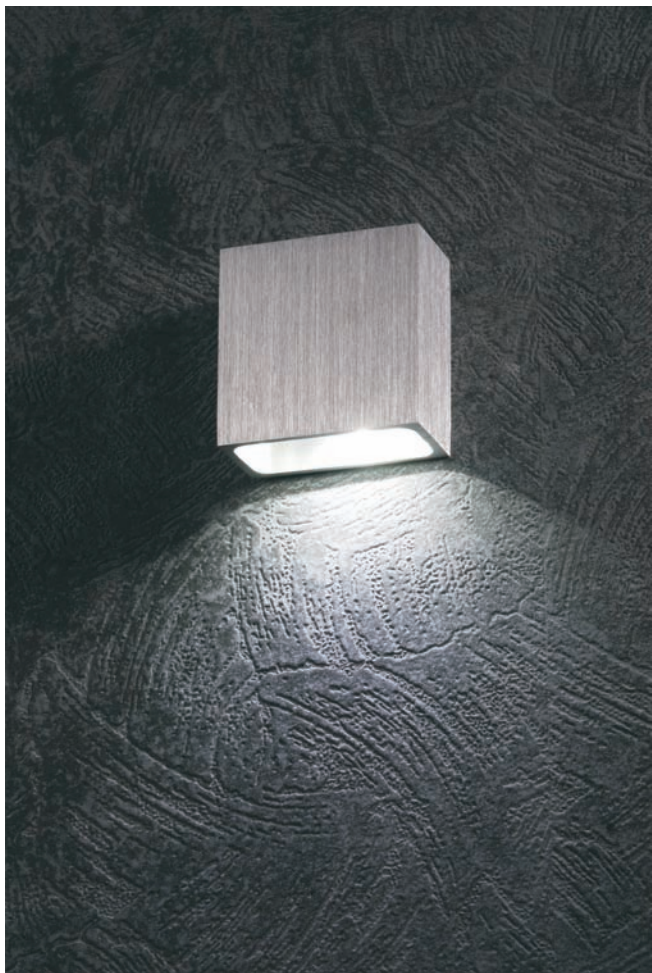

## ● HL004/1

materiál: hliník  
LED 1W / WW  
Ra80 / 100lm  
obsahuje zdroj  
IP20 / class I /   
stříbrná









## ● HL004/2

materiál: hliník  
LED 2X1W / WW  
Ra80 / 100lm  
obsahuje zdroj  
IP20 / class II / **CE**  
stříbrná

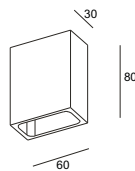



● LWA164

materiál: hliník  
CREE LED 1X3W / WW  
Ra90 / 170lm  
obsahuje zdroj  
IP20 / class II / **CE**  
stříbrná

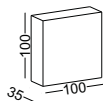

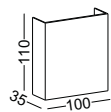

● LWA165

materiál: hliník  
CREE LED 2X3W / WW  
Ra90 / 340lm  
obsahuje zdroj  
IP20 / class II / **CE**  
stříbrná



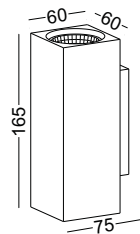

● LWA117

materiál: hliník  
COB LED 2X5W / WW  
Ra80 / 1000lm/38°  
obsahuje zdroj  
IP20 / class I /  $\text{CE}$   
broušená stříbrná  
3000K/4000K/6000K



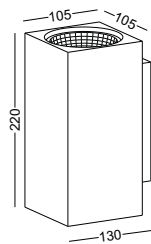

● LWA119

materiál: hliník  
COB LED 2X13W / WW  
Ra80 / 2600lm/38°  
obsahuje zdroj  
IP20 / class I / **CE**  
broušená stříbrná  
3000K/4000K/6000K

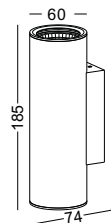

● LWA116

materiál: hliník  
 COB LED 2X5W / WW  
 Ra80 / 1000lm/38°  
 obsahuje zdroj  
 IP20 / class I / **CE**  
 broušená stříbrná  
 3000K/4000K/6000K

● LWA118

materiál: hliník  
 COB LED 2X9W / WW  
 Ra80 / 1800lm/38°  
 obsahuje zdroj  
 IP20 / class I / **CE**  
 broušená stříbrná  
 3000K/4000K/6000K

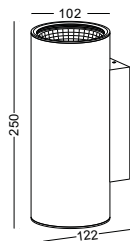





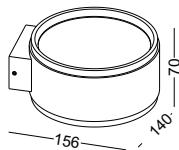

## ● LWA115

materiál: hliník  
SMD LED 2X4.5W / WW  
Ra80 / 900lm  
obsahuje zdroj  
IP20 / class I / **CE**  
bílá  
3000K/4000K/6000K

● HL8072/1

materiál: hliník  
COB LED 5W / WW  
Ra80 / 500lm  
obsahuje zdroj  
IP20 / class I /   
stříbrná  
3000K/4000K/6000K



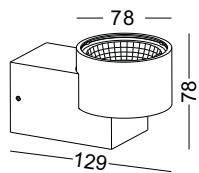

● LWA134

materiál: hliník  
COB LED 5W / WW  
Ra80 / 500lm/38°  
obsahuje zdroj  
IP20 / class I /   
stříbrná  
3000K/4000K/6000K



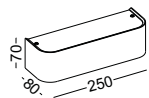
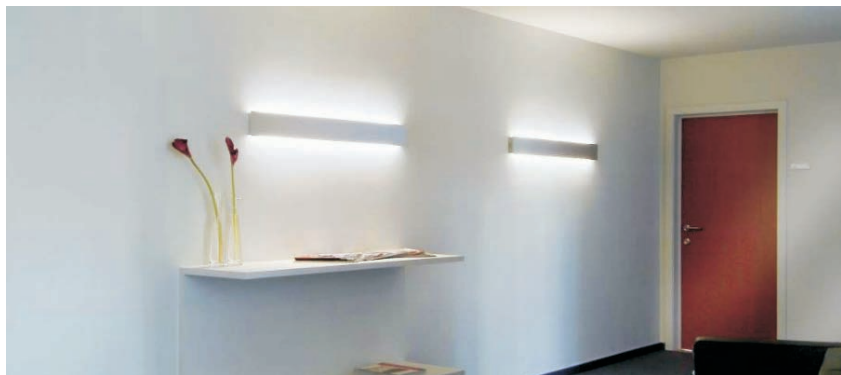

● LWA149-WT

materiál: hliník  
 SMD LED 8W / WW  
 Ra80 / 800lm  
 obsahuje zdroj  
 IP20 / class I /  $\text{CE}$   
 broušená stříbrná/bílá  
 3000K/4000K/6000K

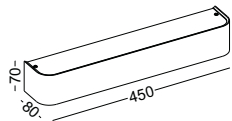

● LWA150-WT

materiál: hliník  
 SMD LED 12W / WW  
 Ra80 / 1200lm  
 obsahuje zdroj  
 IP20 / class I /  $\text{CE}$   
 broušená stříbrná/bílá  
 3000K/4000K/6000K

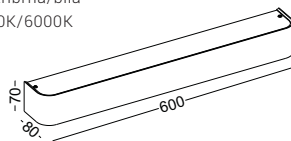

● LWA151-WT

materiál: hliník  
 SMD LED 16W / WW  
 Ra80 / 1600lm  
 obsahuje zdroj  
 IP20 / class I /  $\text{CE}$   
 broušená stříbrná/bílá  
 3000K/4000K/6000K



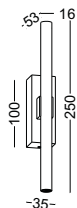
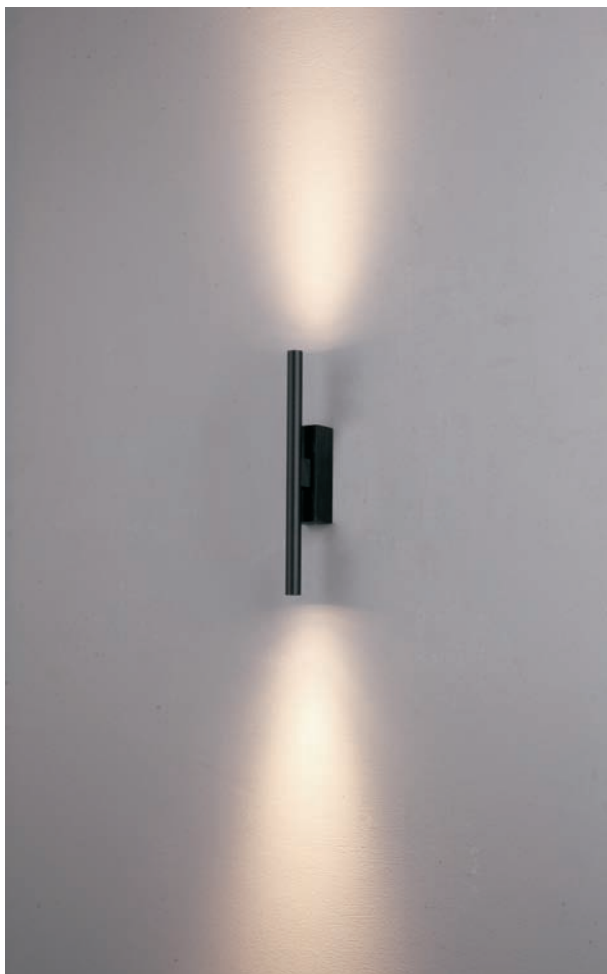

● LWA226

materiál: hliník  
 CREE LED 2W / WW  
 Ra85 / 200lm/3đ  
 obsahuje zdroj  
 IP20 / class I / **CE**  
 černá  
 3000K/4000K/6000K

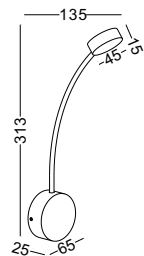

● LWA137

materiál: hliník  
 CREE LED 3W / WW  
 Ra85 / 300lm  
 obsahuje zdroj  
 IP20 / class I / **CE**  
 bílá  
 3000K/4000K/6000K



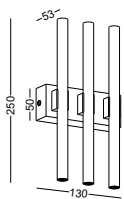

● LWA239

materiál: hliník  
 CREE LED 6W / WW  
 Ra80 /600lm/3Ť  
 obsahuje zdroj  
 IP20 / class I / **CE**  
 Černá  
 3000K/4000K/6000K

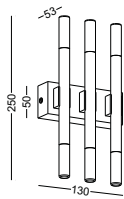

● LWA241

materiál: hliník  
 Akrylový difuzor  
 CREE LED 6W / WW  
 Ra80 /600lm  
 obsahuje zdroj  
 IP20 / class I / **CE**  
 Černá  
 3000K/4000K/6000K

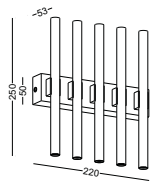

● LWA240

materiál: hliník  
 CREE LED 10W / WW  
 Ra80 /1000lm/3Ť  
 obsahuje zdroj  
 IP20 / class I / **CE**  
 Černá  
 3000K/4000K/6000K

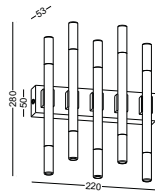

● LWA242

materiál: hliník  
 Akrylový difuzor  
 CREE LED 10W / WW  
 Ra80 /1000lm  
 obsahuje zdroj  
 IP20 / class I / **CE**  
 Černá  
 3000K/4000K/6000K

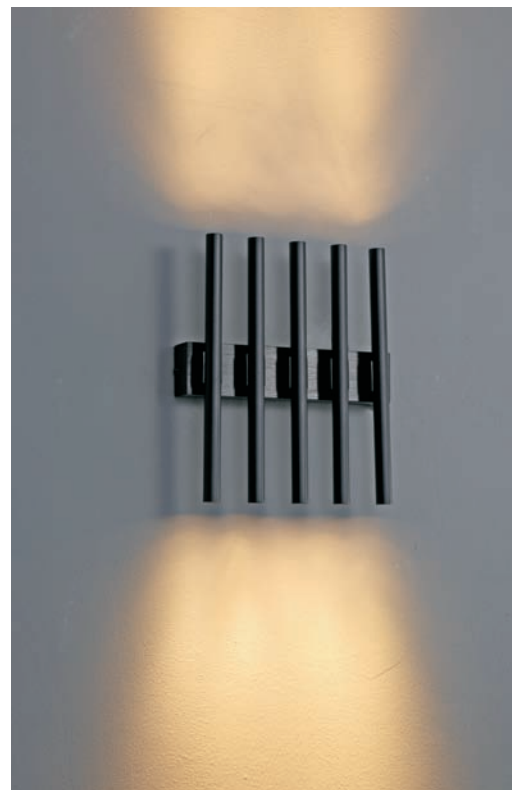

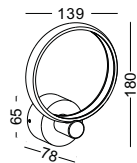

● LWA223

materiál: hliník  
 SMD LED 6W / WW  
 Ra80 / 600lm/  
 obsahuje zdroj  
 IP20 / class I /   
 Chrom  
 3000K/4000K/6000K

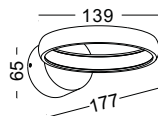

● LWA222

materiál: hliník  
 SMD LED 6W / WW  
 Ra80 / 600lm/  
 obsahuje zdroj  
 IP20 / class I /   
 Chrom  
 3000K/4000K/6000K

● LWA141

materiál: hliník  
SMD LED 4W / WW  
Ra80 / 400lm  
obsahuje zdroj  
IP20 / class II / CE  
bilá

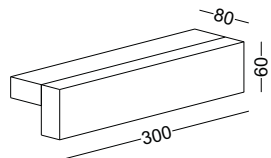

● LWA142

materiál: hliník  
SMD LED 8W / WW  
Ra80 / 800lm  
obsahuje zdroj  
IP20 / class II / CE  
bilá  
3000K/4000K/6000K

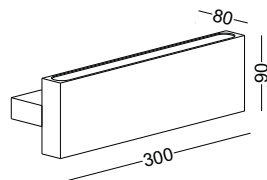



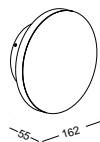

- LWA228A-BK
- Material: Hliník
- Akrylové stínitko
- SMD LED 4W / WW
- Ra80 / 400lm
- obsahuje zdroj
- IP20 / class I / **CE**
- Černý kryt
- 3000K/4000K/ 6000K

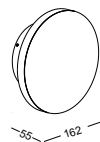

- LWA228A-WT
- Material: Hliník
- Akrylové stínitko
- SMD LED 4W / WW
- Ra80 / 400lm
- obsahuje zdroj
- IP20 / class I / **CE**
- Bílý kryt
- 3000K/4000K/ 6000K

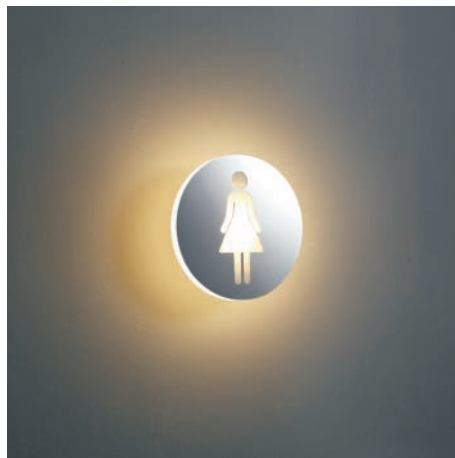
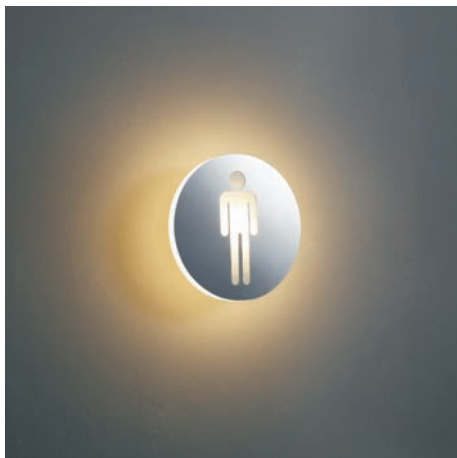
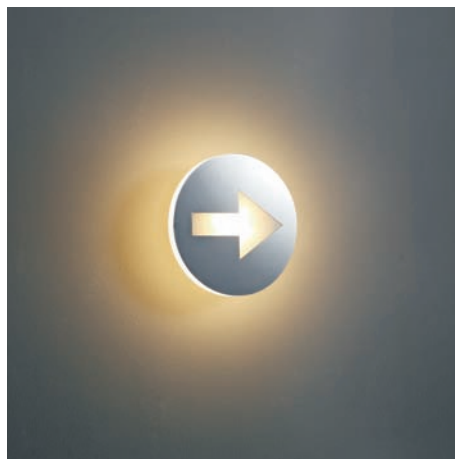
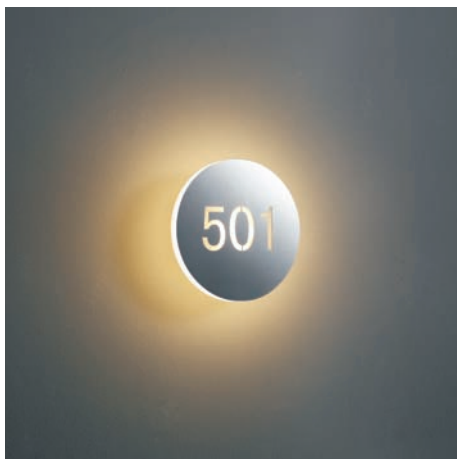

● LWA228B

Material: Hliník  
Akrylové stínítko  
SMD LED 4W / WW  
Ra80 / 400lm  
obsahuje zdroj  
IP20 / class I / **CE**  
Barva ocel  
3000K/4000K/6000K



● LWA228C

Material: Hliník  
Akrylové stínítko  
SMD LED 4W / WW  
Ra80 / 400lm  
obsahuje zdroj  
IP20 / class I / **CE**  
Barva ocel  
3000K/4000K/6000K



● LWA228D

Material: Hliník  
Akrylové stínítko  
SMD LED 4W / WW  
Ra80 / 400lm  
obsahuje zdroj  
IP20 / class I / **CE**  
Barva ocel  
3000K/4000K/6000K



● LWA228E

Material: Hliník  
Akrylové stínítko  
SMD LED 4W / WW  
Ra80 / 400lm  
obsahuje zdroj  
IP20 / class I / **CE**  
Barva ocel  
3000K/4000K/6000K

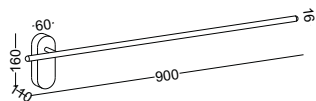

● LWA243

Material: Hliník  
SMD LED 10W / WW  
Ra80 / 1000lm  
obsahuje zdroj  
IP20 / class I / **CE**  
černá  
3000K/4000K/6000K



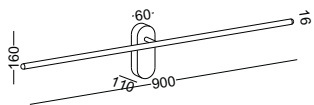

● LWA244

Material: Hliník  
SMD LED 10W / WW  
Ra80 / 1000lm  
obsahuje zdroj  
IP20 / class I /   
černá  
3000K/4000K/6000K

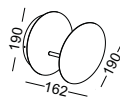

● LWA221

Material: Matná ocel  
SMD LED 6W / WW  
Ra80 / 600lm  
obsahuje zdroj  
IP20 / class I / **CE**  
bílá  
3000K/4000K/6000K



# LED NÁSTĚNNÉ OSVĚTLENÍ ZAPUŠTĚNÉ

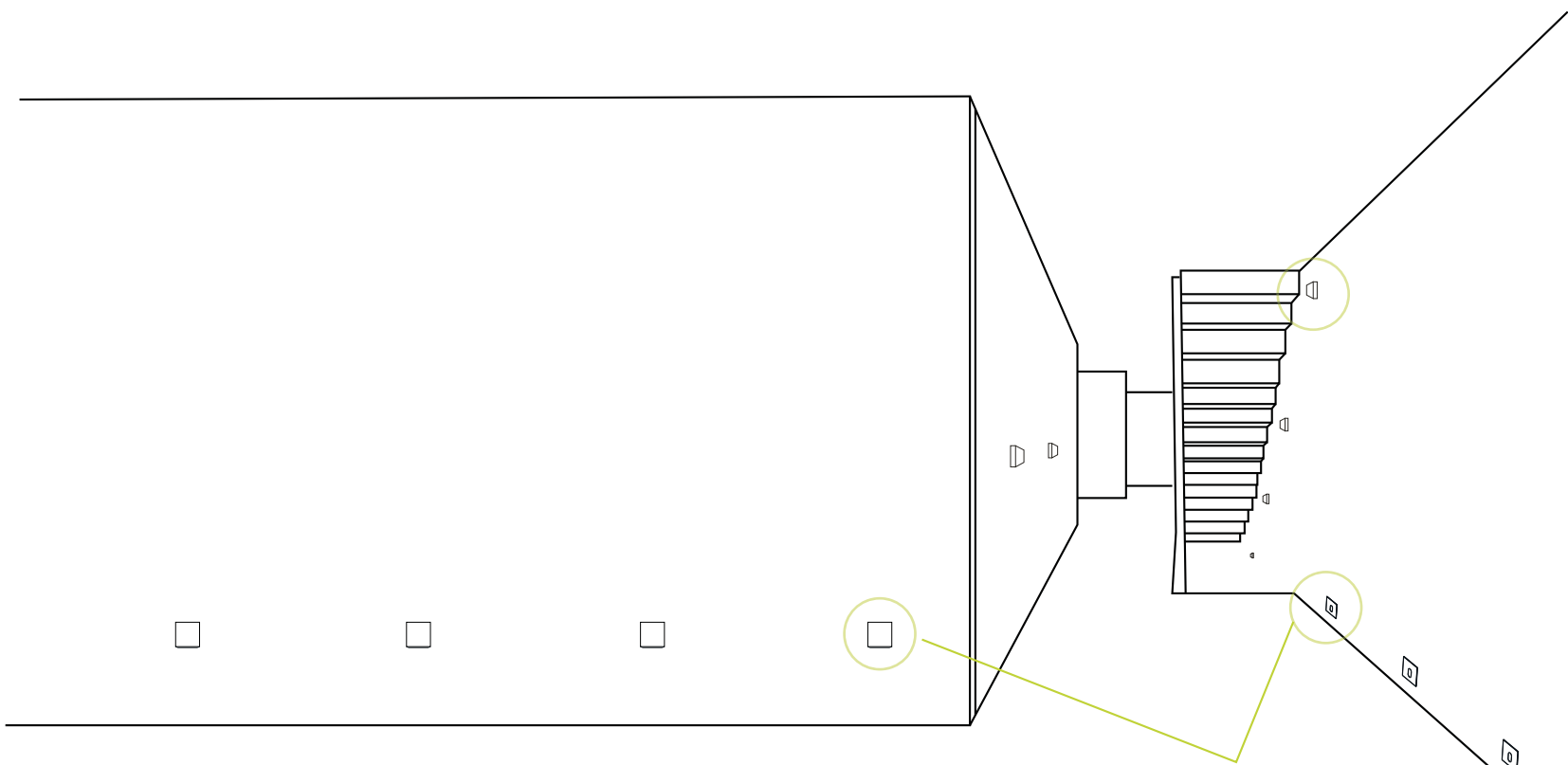

## led podsvícení

Serie LSL001 využívá 1W CREE čipy, se svítivostí 100lm na 1 Watt. Ochrana IP20. Různé modely pro zdi, rohy a schodiště

Využití: šatny, obchody, hotely, kluby, byty, kanceláře, restaurace, lázně, studia, rezidenční budovy, chodby a jiné.

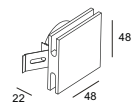

## ● LSL003

materiál: hliník  
 LED 1W / WW  
 Ra90 / 122lm  
 bez zdroje  
 IP20 / class III /   
 stříbrná  
 průměr výřezu 4cm

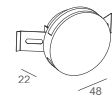

## ● LSL004

materiál: hliník  
 LED 1W / WW  
 Ra90 / 122lm  
 bez zdroje  
 IP20 / class III /   
 stříbrná  
 průměr výřezu 4cm



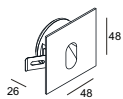

● LSL001

materiál: hliník  
LED 1W / WW  
Ra90 / 122lm  
bez zdroje  
IP20 / class III / **CE**  
stříbrná  
průměr výřezu 4cm



● LSL002

materiál: hliník  
LED 1W / WW  
Ra90 / 122lm  
bez zdroje  
IP20 / class III / **CE**  
stříbrná  
průměr výřezu 4cm

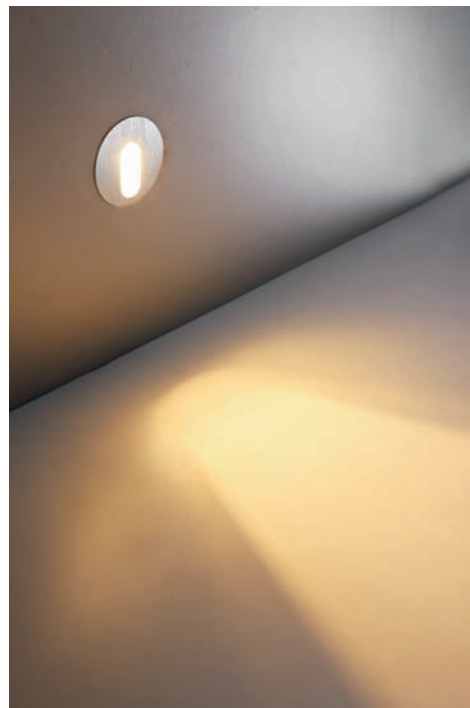
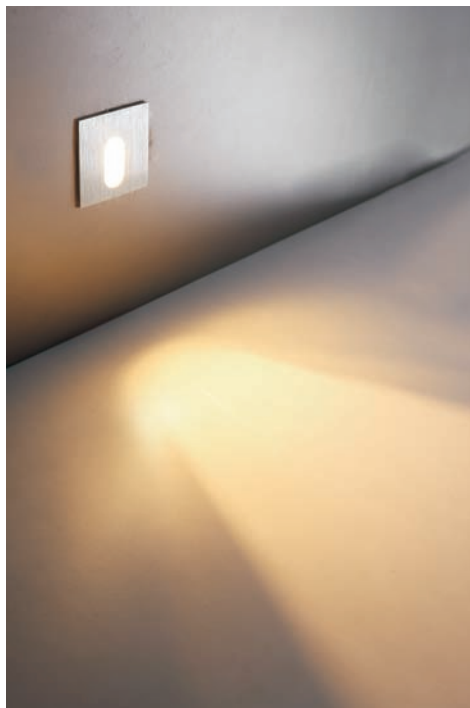

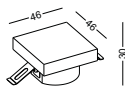

● LSL008

materiál: hliník  
 a akrylové stínítko  
 CREE LED 1W / WW  
 Ra90 / 122lm  
 bez zdroje  
 IP20 / class III /  $\text{CE}$   
 stříbrná  
 průměr výřezu 4cm

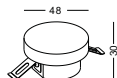

● LSL009

materiál: hliník  
 a akrylové stínítko  
 CREE LED 1W / WW  
 Ra90 / 122lm  
 bez zdroje  
 IP20 / class III /  $\text{CE}$   
 stříbrná  
 průměr výřezu 4cm

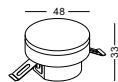
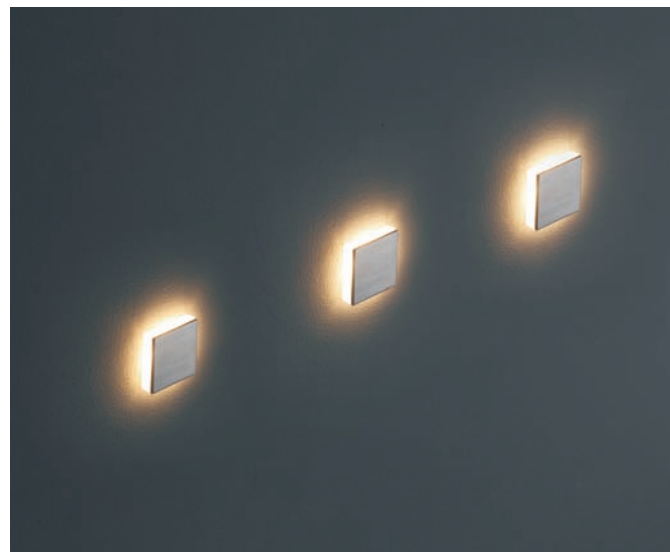

● LSL009A

materiál: hliník  
a akrylové stínítko  
barva ocel  
CREE LED 1W / WW  
Ra90 / 122lm  
bez zdroje  
IP20 / class III / **CE**  
stříbrná  
průměr výřezu 4cm

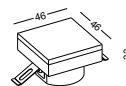

● LSL008A

materiál: hliník  
a akrylové stínítko  
barva ocel  
CREE LED 1W / WW  
Ra90 / 122lm  
bez zdroje  
IP20 / class III / **CE**  
stříbrná  
průměr výřezu 4cm

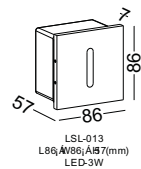
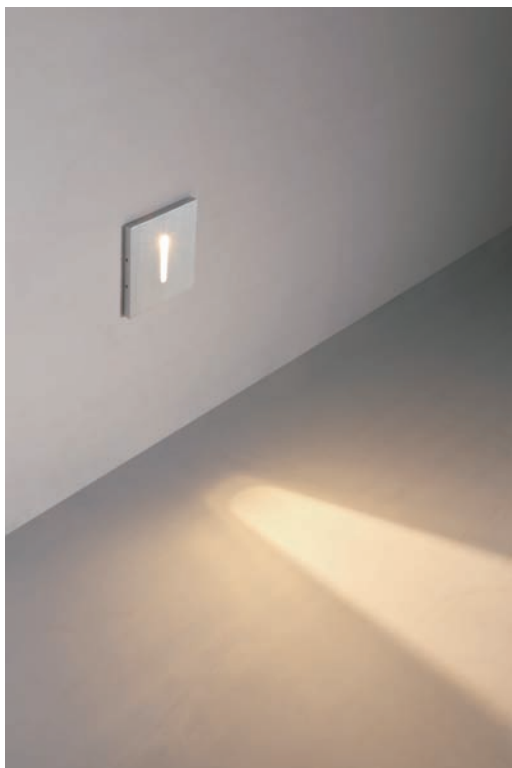

● **LSL013**

materiál: hliník  
 CREE LED 1W / WW  
 Ra90 / 122lm  
 bez zdroje  
 IP20 / class III /  $\text{CE}$   
 stříbrná  
 průměr výřezu 5cm  
 lze instalovat na  
 standardní 86mm zásuvkový box

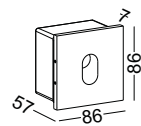

● **LSL011**

materiál: hliník  
 CREE LED 1W / WW  
 Ra90 / 122lm  
 bez zdroje  
 IP20 / class III /  $\text{CE}$   
 stříbrná  
 průměr výřezu 5cm  
 lze instalovat na standardní  
 86mm zásuvkový box

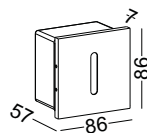
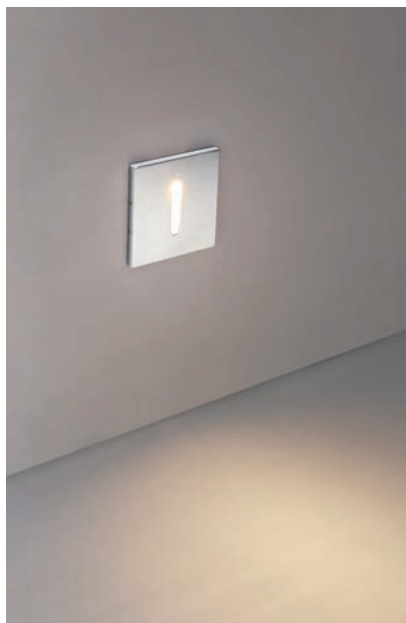

● LSL013A

materiál: hliník  
 CREE LED 1W / WW  
 Ra90 / 122lm  
 difuzor "zamrzlé sklo"  
 bez zdroje  
 IP20 / class III / CE  
 Chrom  
 průměr výřezu 5cm  
 lze instalovat na standardní  
 86mm zásuvkový box

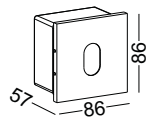
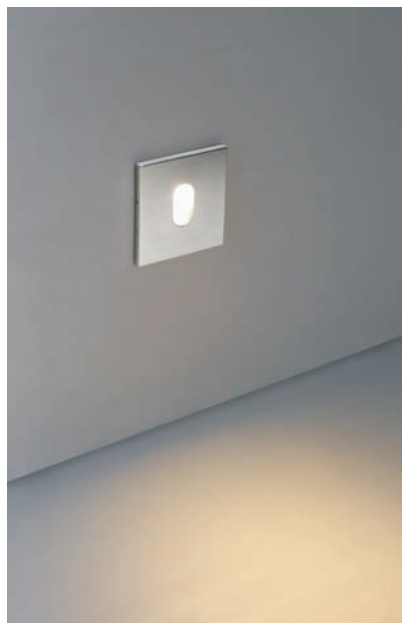

● LSL011A

materiál: hliník  
 CREE LED 1W / WW  
 Ra90 / 122lm  
 difuzor "zamrzlé sklo"  
 bez zdroje  
 IP20 / class III / CE  
 Chrom  
 průměr výřezu 5cm  
 lze instalovat na standardní  
 86mm zásuvkový box

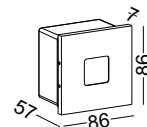

● LSL012A

materiál: hliník  
 CREE LED 1W / WW  
 Ra90 / 122lm  
 difuzor "zamrzlé sklo"  
 bez zdroje  
 IP20 / class III / CE  
 Chrom  
 průměr výřezu 5cm  
 lze instalovat na standardní  
 86mm zásuvkový box





# LED OSVĚTLENÍ KOUPELEN LOŽNIC A ZRCADEL





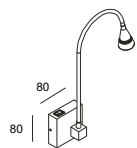

● LWA067

materiál: hliník  
 LED 1X3W / WW  
 Ra90 / 170lm/30°  
 obsahuje zdroj  
 IP20 / class I / CE  
 stříbrná  
 3000K/4000K/ 6000K  
 vypínač na základně

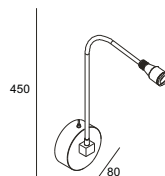

● LWA070B

materiál: hliník  
 LED 1X3W / WW  
 Ra90 / 170lm/30°  
 obsahuje zdroj  
 IP20 / class I / CE  
 stříbrná  
 3000K/4000K/ 6000K  
 vypínač na základně

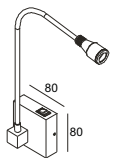

● LWA070

materiál: hliník  
LED 1X3W / WW  
Ra90 / 170lm/30°  
obsahuje zdroj  
IP20 / class I / CE  
stříbrná  
3000K/4000K/ 6000K  
vypínač na základně

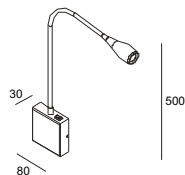

● LWA061

materiál: hliník  
LED 1X3W / WW  
Ra90 / 170lm/30°  
obsahuje zdroj  
IP20 / class I / CE  
stříbrná  
3000K/4000K/ 6000K  
vypínač na základně

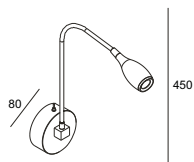

● **LWA067B**

materiál: hliník  
LED 1X3W / WW  
Ra90 / 170lm/30°  
obsahuje zdroj  
IP20 / class I /  $\text{CE}$   
stříbrná  
3000K/4000K/ 6000K  
vypínač na základně

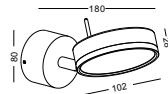

● **LWA186**

materiál: hliník  
COB LED 5W / WW  
Ra85 / 500lm  
obsahuje zdroj  
IP20 / class I /  $\text{CE}$   
stříbrná  
3000K/4000K/ 6000K  
vypínač na základně

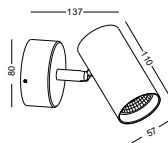

● LWA187

materiál: hliník  
 COB LED 5W / WW  
 Ra85 / 500lm/38°  
 obsahuje zdroj  
 IP20 / class I / CE  
 černá  
 3000K/4000K/ 6000K  
 vypínač na základně

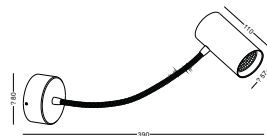

● LWA188

materiál: hliník  
 COB LED 5W / WW  
 Ra85 / 500lm/38°  
 obsahuje zdroj  
 IP20 / class I / CE  
 černá  
 3000K/4000K/ 6000K  
 vypínač na základně



● HL8019A

materiál: hliník  
 CREE LED 3W / WW  
 Ra85 / 170lm/30°  
 obsahuje zdroj  
 IP20 / class I / CE  
 stříbrná  
 3000K/4000K/6000K



● HL9003/1

materiál: hliník  
 CREE LED 3W / WW  
 Ra85 / 170lm/30°  
 obsahuje zdroj  
 IP20 / class I / CE  
 stříbrná  
 3000K/4000K/6000K



● HL8019B

materiál: hliník  
 CREE LED 3W / WW  
 Ra85 / 170lm/30°  
 obsahuje zdroj  
 IP20 / class I / CE  
 stříbrná  
 3000K/4000K/6000K

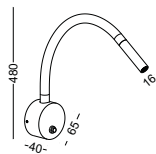

● LWA224

materiál: hliník  
 CREE LED 1W / WW  
 Ra85 / 100lm/30 stupňů  
 obsahuje zdroj  
 IP20 / class I / CE  
 Chrom  
 3000K/4000K/6000K

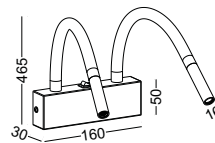

● LWA225

materiál: hliník  
 CREE LED 2x1W / WW  
 Ra85 / 200lm/30 stupňů  
 obsahuje zdroj  
 IP20 / class I / CE  
 Chrom  
 3000K/4000K/6000K

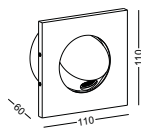

● LWA220-WT

materiál: hliník  
 CREE LED 3W / WW  
 Ra85 / 170lm/30°  
 bez zdroje  
 IP20 / class III /CE  
 bílá  
 3000K/4000K/6000K  
 hlava s 350 stupňovou rotací  
 vypnutí při zavření  
 průměr výřezu 82mmx60mm

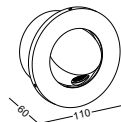

● LWA219-WT

materiál: hliník  
 CREE LED 3W / WW  
 Ra85 / 170lm/30°  
 obsahuje zdroj  
 IP20 / class III /CE  
 bílá 3000K/4000K/6000K  
 hlava s 350 stupňovou rotací  
 vypnutí při zavření  
 průměr výřezu 82mmx60mm

*Tato série je speciálně navržena pro luxusní hotely a majitele domů s dobrým vkusem. Jednoduchý design skrývá promyšlený systém. Lampu lze otáčet o 350 stupňů a pokud hlavu zavřete, automaticky se vypne. Svítidlo je z hliníku, ovšem kryt je vyroben z jednoho kusu oceli a chromován pro ušlechtilý vzhled a větší odolnost. Usazení lampy je zapuštěno v loži s průměrem 81mm a hloubkou 6-8mm. Zdroj je umístěn mimo svítidlo.*



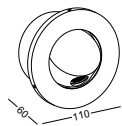

● LWA219-CR

materiál: hliník  
 CREE LED 3W / WW  
 Ra85 / 170lm/30°  
 obsahuje zdroj  
 IP20 / class III  $\text{KE}$   
 leštěný chrom  
 3000K/ 4000K/ 6000K  
 hlava s 350 stupňovou rotací  
 vypnutí při zavření  
 průměr výřezu 82mmx60mm

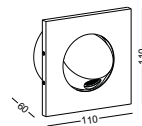

● LWA220-CR

materiál: hliník  
 CREE LED 3W / WW  
 Ra85 / 170lm/30°  
 bez zdroje  
 IP20 / class III  $\text{KE}$   
 leštěný chrom  
 3000K/ 4000K/ 6000K  
 hlava s 350 stupňovou rotací  
 vypnutí při zavření  
 průměr výřezu 82mmx60mm

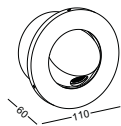

● LWA219-SL

materiál: hliník  
 CREE LED 3W / WW  
 Ra85 / 170lm/30°  
 obsahuje zdroj  
 IP20 / class III **CE**  
 stříbrná  
 3000K/4000K/ 6000K  
 hlava s 350 stupňovou rotací  
 vypnutí při zavření  
 průměr výřezu 82mmx60mm

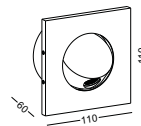

● LWA220-SL

materiál: hliník  
 CREE LED 3W / WW  
 Ra85 / 170lm/30°  
 bez zdroje  
 IP20 / class III **CE**  
 stříbrná  
 3000K/4000K/ 6000K  
 hlava s 350 stupňovou rotací  
 vypnutí při zavření  
 průměr výřezu 82mmx60mm

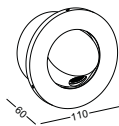

● LWA219-BK

materiál: hliník  
CREE LED 3W / WW  
Ra85 / 170lm/3đ  
obsahuje zdroj  
IP20 / class III **CE**  
černá  
3000K/4000K/ 6000K  
hlava s 350 stupňovou rotací  
vypnutí při zavření  
průměr výřezu 82mmx60mm

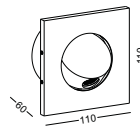

● LWA220-BK

materiál: hliník  
CREE LED 3W / WW  
Ra85 / 170lm/3đ  
bez zdroje  
IP20 / class III **CE**  
černá  
3000K/4000K/ 6000K  
hlava s 350 stupňovou rotací  
vypnutí při zavření  
průměr výřezu 82mmx60mm

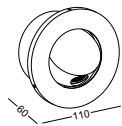

● LWA219-RD

materiál: hliník  
 CREE LED 3W / WW  
 Ra85 / 170lm/30°  
 obsahuje zdroj  
 IP20 / class III **CE**  
 růžové zlato  
 3000K/4000K/ 6000K  
 hlava s 350 stupňovou rotací  
 vypnutí při zavření  
 průměr výřezu 82mmx60mm





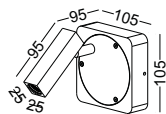

● LWA203

materiál: hliník CREE  
 LED 3W / WW Ra85 /  
 170lm/30°  
 obsahuje zdroj  
 IP20 / class I / CE  
 černá  
 3000K/4000K/ 6000K  
 vypínač na základně

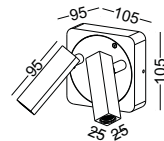

● LWA204

materiál: hliník  
 CREE LED 2X3W / WW  
 Ra85 / 340lm/30°  
 obsahuje zdroj  
 IP20 / class I / CE  
 černá  
 3000K/4000K/ 6000K  
 vypínač na základně

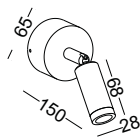

● LWA205

materiál: hliník  
 CREE LED 3W / WW  
 Ra85 / 170lm/30°  
 obsahuje zdroj  
 IP20 / class I / CE  
 černá  
 3000K/4000K/ 6000K  
 vypínač na základni

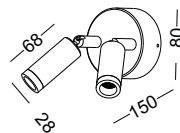

● LWA206

materiál: hliník  
 CREE LED 2X3W / WW  
 Ra85 / 340lm/30°  
 obsahuje zdroj  
 IP20 / class I / CE  
 černá  
 3000K/4000K/ 6000K  
 vypínač na základni







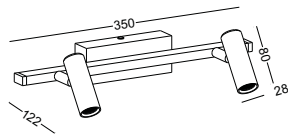

● LWA189

materiál: hliník  
 CREE LED 2X3W / WW  
 Ra85 / 340lm/30°  
 obsahuje zdroj  
 IP20 / class I / **CE**  
 černá  
 3000K/ 4000K/ 6000K

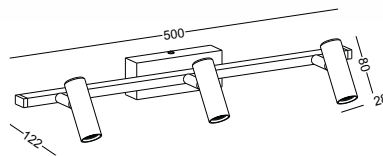

● LWA190

materiál: hliník  
 CREE LED 3X3W / WW  
 Ra85 / 510lm/30°  
 obsahuje zdroj  
 IP20 / class I / **CE**  
 černá  
 3000K/ 4000K/ 6000K

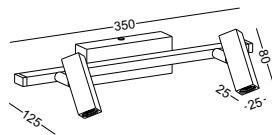

● LWA191

materiál: hliník  
 CREE LED 2X3W / WW  
 Ra85 / 340lm/3Ŕ  
 obsahuje zdroj  
 IP20 / class I / **CE**  
 ěrná  
 3000K/ 4000K/ 6000K

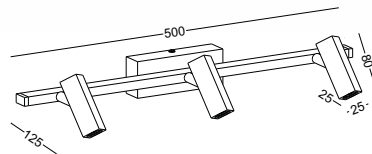

● LWA192

materiál: hliník  
 CREE LED 3X3W / WW  
 Ra85 / 510lm/3Ŕ  
 obsahuje zdroj  
 IP20 / class I / **CE**  
 ěrná  
 3000K/ 4000K/ 6000K

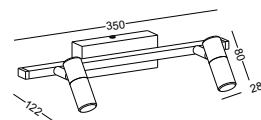

● LWA193

materiál: hliník  
 CREE LED 2X3W / WW  
 Ra85 / 340lm  
 obsahuje zdroj  
 IP20 / class I **CE**  
 černá  
 3000K/ 4000K/ 6000K  
 akrylový difuzor

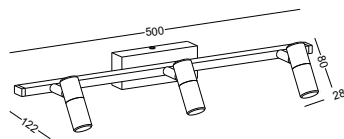

● LWA194

materiál: hliník  
 CREE LED 3X3W / WW  
 Ra85 / 510lm  
 obsahuje zdroj  
 IP20 / class I **CE**  
 černá  
 3000K/ 4000K/ 6000K  
 akrylový difuzor

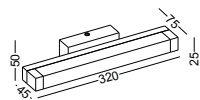

● LWA195

materiál: hliník  
akrylový difuzor  
CREE LED 6W / WW  
Ra85 / 600lm  
obsahuje zdroj  
IP20 / class I / **CE**  
černá  
3000K/4000K/6000K

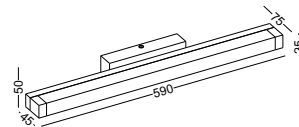

● LWA196

materiál: hliník  
akrylový difuzor  
CREE LED 12W / WW  
Ra85 / 1200lm  
obsahuje zdroj  
IP20 / class I / **CE**  
černá  
3000K/4000K/6000K

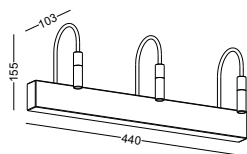

● LWA235

materiál : hliník  
akrylový difuzor  
CREE LED 3W / WW  
Ra85 / 366lm  
obsahuje zdroj  
IP20 / class I / **CE**  
chrom  
3000K/ 4000K/6000K

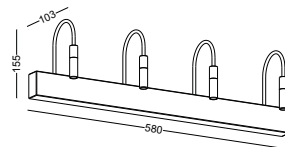

● LWA236

materiál : hliník  
akrylový difuzor  
CREE LED 4W / WW  
Ra85 / 488lm  
obsahuje zdroj  
IP20 / class I / **CE**  
chrom  
3000K/ 4000K/6000K

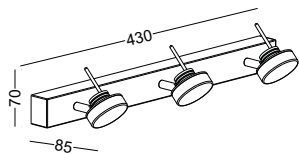
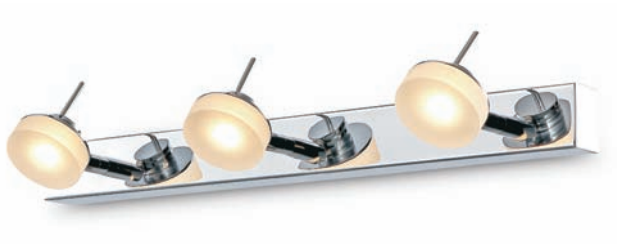

● LWA237

materiál: hliník  
akrylový difuzor  
CREE LED 9W / WW  
Ra85 / 510lm  
obsahuje zdroj  
IP20 / class I /  $\text{CE}$   
chrom  
3000K/ 4000K/6000K

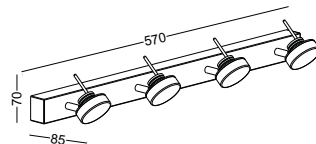
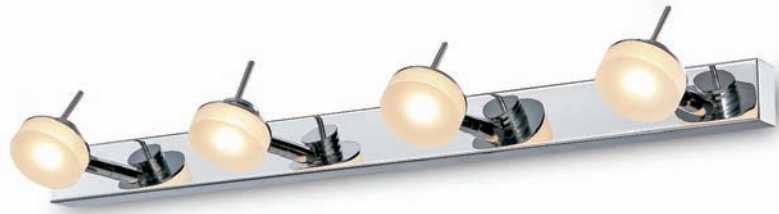

● LWA238

materiál: hliník  
akrylový difuzor  
CREE LED 12W / WW  
Ra85 / 680lm  
obsahuje zdroj  
IP20 / class I /  $\text{CE}$   
chrom  
3000K/ 4000K/6000K







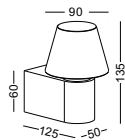

#### ● LWA207A

materiál: hliník  
 COB LED 5W / WW  
 Ra85 / 500lm  
 obsahuje zdroj  
 IP20 / class I / **CE**  
 stříbrná  
 3000K/4000K/6000K  
 akrylový difuzor

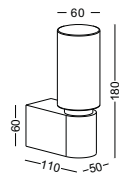

#### ● LWA208A

materiál: hliník  
 COB LED 5W / WW  
 Ra85 / 500lm  
 obsahuje zdroj  
 IP20 / class I / **CE**  
 stříbrná  
 3000K/4000K/6000K  
 akrylový difuzor

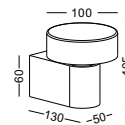
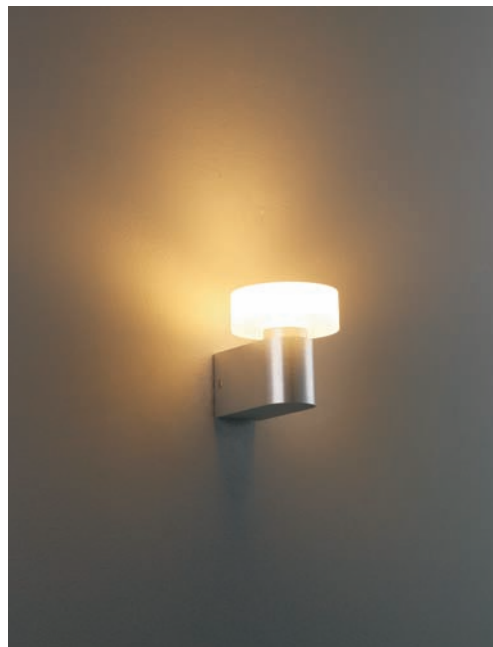

#### ● LWA209A

materiál: hliník  
 COB LED 5W / WW  
 Ra85 / 500lm  
 obsahuje zdroj  
 IP20 / class I / **CE**  
 stříbrná  
 3000K/4000K/6000K  
 akrylový difuzor

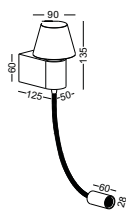

● **LWA207B**

materiál: hliník  
akrylový difuzor  
COB LED 5W  
+ CREE 3W / WW  
Ra85 / 670lm  
obsahuje zdroj  
IP20 / class I / **CE**  
stříbrná a černá  
3000K/ 4000K/  
6000K

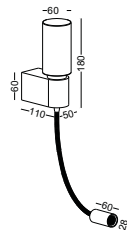

● **LWA208B**

materiál: hliník  
akrylový difuzor  
COB LED 5W  
+ CREE 3W / WW  
Ra85 / 670lm  
obsahuje zdroj  
IP20 / class I / **CE**  
stříbrná a černá  
3000K/ 4000K/6000K

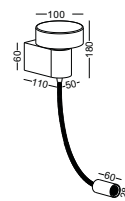

● **LWA209B**

materiál: hliník  
akrylový difuzor  
COB LED 5W  
+ CREE 3W / WW  
Ra85 / 670lm  
obsahuje zdroj  
IP20 / class I / **CE**  
stříbrná a černá  
3000K/ 4000K/6000K

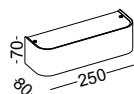

● LWA149-SL

materiál: hliník  
 SMD LED 2X4W / WW  
 Ra85 / 800lm  
 obsahuje zdroj IP20 /  
 class I / **CE**  
 stříbrná  
 3000K/ 4000K/ 6000K

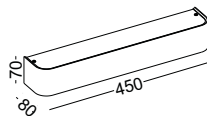

● LWA150-SL

materiál: hliník  
 SMD LED 2X6W / WW  
 Ra85 / 1200lm  
 obsahuje zdroj  
 IP20 / class I / **CE**  
 stříbrná  
 3000K/ 4000K/ 6000K

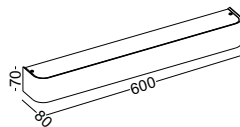

● LWA151-SL

materiál: hliník  
SMD LED 2X8W / WW  
Ra85 / 1600lm  
obsahuje zdroj  
IP20 / class I / **CE**  
stříbrná  
3000K/ 4000K/ 6000K





● LWA200-BK

materiál: hliník CREE  
LED 3W / WW Ra85 /  
170lm/30 stupňů  
obsahuje zdroj  
IP20 / class II/CE  
černá  
3000K/ 4000K/ 6000K  
měkký pogumovný krk



● LWA200-BK

materiál: hliník CREE  
LED 3W / WW Ra85 /  
170lm/30 stupňů  
obsahuje zdroj  
IP20 / class II/CE  
černá  
3000K/ 4000K/ 6000K  
měkký pogumovný krk

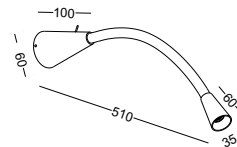

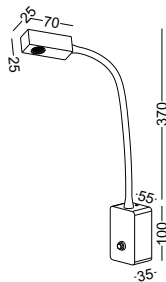

● LWA231A-WT

materiál: hliník  
 CREE LED 3W / WW  
 Ra85 / 170lm/30 stupňů  
 obsahuje zdroj  
 IP20 / class I / CE  
 bílá 3000K/ 4000K/  
 6000K  
 ohebný pogumovaný krk  
 dotykový vypínač

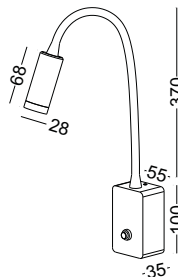

● LWA232A-BK

materiál: hliník  
 CREE LED 3W / WW  
 Ra85 / 170lm/30 stupňů  
 obsahuje zdroj  
 IP20 / class I / CE  
 bílá  
 3000K/ 4000K/6000K  
 ohebný pogumovaný krk  
 dotykový vypínač



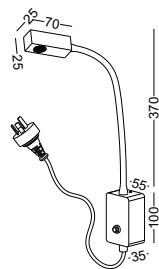

● LWA231B-WT

materiál: hliník  
 CREE LED 3W / WW  
 Ra85 / 170lm/30 stupňů  
 obsahuje zdroj  
 IP20 / class I / CE  
 bílá  
 3000K/ 4000K/6000K  
 ohebný pogumovaný krk  
 dotykový vypínač  
 s kabelem do zásuvky

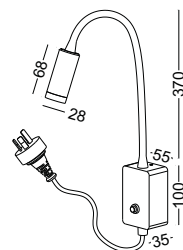

● LWA232B-BK

materiál: hliník  
 CREE LED 3W / WW  
 Ra85 / 170lm/30 stupňů  
 obsahuje zdroj  
 IP20 / class I / CE  
 Černá  
 3000K/4000K/ 6000K  
 ohebný pogumovaný krk  
 dotykový vypínač  
 s kabelem do zásuvky





● LWA230-CR

materiál: hliník  
 CREE LED 3W / WW  
 Ra85 / 170lm/30 stupňů  
 obsahuje zdroj  
 IP20 / class I / CE  
 chrom  
 3000K/ 4000K/6000K  
 ohebný krk  
 dotykový vypínač  
 zápustný - průměr výřezu  
 82mmx60mm

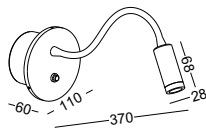

● LWA230A-CR

materiál: hliník  
 CREE LED 3W / WW  
 Ra85 / 170lm/30 stupňů  
 obsahuje zdroj  
 IP20 / class I / CE  
 chrom  
 3000K/ 4000K/6000K  
 ohebný krk  
 dotykový vypínač  
 zápustný - průměr výřezu  
 82mmx60mm

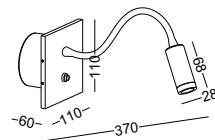



● LWA230A-WT

materiál: hliník  
 CREE LED 3W / WW  
 Ra85 / 170lm/30 stupňů  
 obsahuje zdroj  
 IP20 / class I / CE  
 bílá  
 3000K/ 4000K/6000K  
 dotykový vypínač  
 zápustný - průměr výřezu  
 82mmx60mm

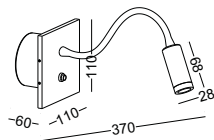

● LWA230A-BK

materiál: hliník  
 CREE LED 3W / WW  
 Ra85 / 170lm/30 stupňů  
 obsahuje zdroj  
 IP20 / class I / CE  
 černá  
 3000K/ 4000K/6000K  
 dotykový vypínač  
 zápustný - průměr výřezu  
 82mmx60mm

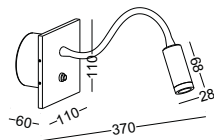

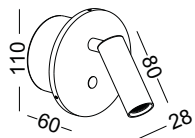

● LWA260-CR

materiál: hliník  
 CREE LED 3W / WW  
 Ra85 / 170lm/30 stupňů  
 obsahuje zdroj  
 IP20 / class I / CE  
 chrom  
 3000K/ 4000K/6000K  
 dotykový vypínač  
 zápusťný - průměr  
 výřezu 82mmx60mm  
 přesně

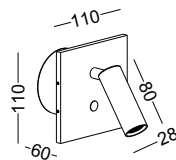

● LWA259-CR

materiál: hliník  
 CREE LED 3W / WW  
 Ra85 / 170lm/30 stupňů  
 obsahuje zdroj  
 IP20 / class I / CE  
 chrom  
 3000K/ 4000K/6000K  
 dotykový vypínač  
 zápusťný - průměr  
 výřezu 82mmx60mm  
 přesně

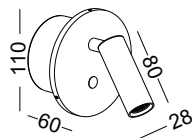

● LWA260-BK

materiál: hliník  
 CREE LED 3W / WW  
 Ra85 / 170lm/30 stupňů  
 obsahuje zdroj  
 IP20 / class I / **CE**  
 černá  
 3000K/ 4000K/6000K  
 dotykový vypínač  
 zápusťný - průměrvýřezu  
 82mmx60mm

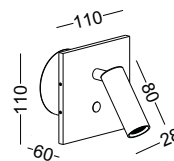

● LWA259-BK

materiál: hliník  
 CREE LED 3W / WW  
 Ra85 / 170lm/30 stupňů  
 obsahuje zdroj  
 IP20 / class I / **CE**  
 černá  
 3000K/ 4000K/6000K  
 dotykový vypínač  
 zápusťný - průměrvýřezu  
 82mmx60mmprecisely



● LWA259-WT

materiál: hliník  
 CREE LED 3W / WW  
 Ra85 / 170lm/30 stupňů  
 obsahuje zdroj  
 IP20 / class I / CE  
 bílá  
 3000K/ 4000K/6000K  
 dotykový vypínač  
 zápustný - průměr výřezu  
 82mmx60mm

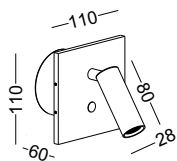

● LWA260-WT

materiál: hliník  
 CREE LED 3W / WW  
 Ra85 / 170lm/30 stupňů  
 obsahuje zdroj  
 IP20 / class I / CE  
 bílá  
 3000K/ 4000K/6000K  
 dotykový vypínač  
 zápustný - průměr výřezu  
 82mmx60mm

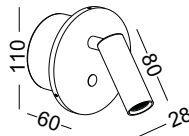

# LED ZÁVĚSNÁ SVÍTIDLA

ZÁVĚSNÁ



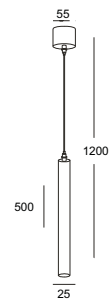

● **HL012-WT**

materiál: hliník  
 CREE LED 3W / WW  
 Ra90 / 170lm / 30°  
 obsahuje zdroj  
 IP20 / class I / **CE**  
 bílá  
 3000K/4000K/6000K

● **HL012-BK**

Černá







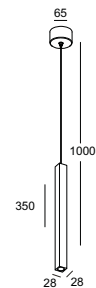

● *LPL045-WT*

materiál: hliník  
LED 3W / WW  
Ra90 / 170lm / 30°  
obsahuje zdroj  
IP20 / class I / CE  
bílá  
3000K / 4000K / 6000K

● *LPL045-BK*

Černá

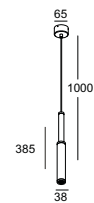

● **LPL149**

materiál: hliník LED  
 3W / WW  
 Ra90 / 366lm / 30°  
 obsahuje zdroj  
 IP20 / class I / **CE**  
 černá  
 3000K/ 4000K/ 6000K

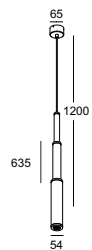

● **LPL150**

materiál: hliník  
 LED 6W / WW  
 Ra90 / 732lm / 30°  
 obsahuje zdroj  
 IP20 / class I / **CE**  
 černá  
 3000K/ 4000K/ 6000K

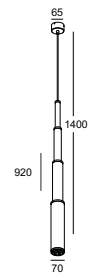

● **LPL151**

materiál: hliník LED  
 9W / WW  
 Ra90 / 1098lm / 30°  
 obsahuje zdroj  
 IP20 / class I / **CE**  
 černá  
 3000K/ 4000K/ 6000K



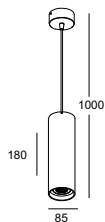

● LPL118

materiál: hliník  
LED 3W / WW  
Ra90 / 366lm / 30°  
obsahuje zdroj  
IP20 / class I /   
bilá 3000K/4000K/6000K



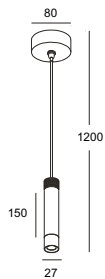

● LPL002

materiál: hliník  
CREE LED 3W / WW  
Ra90 / 170lm / 30 °  
obsahuje zdroj  
IP20 / class I / **CE**  
stříbrná  
3000K/4000K/6000K





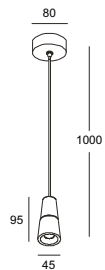

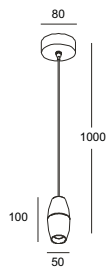

● **LPL042**

materiál: hliník  
LED 3W / WW  
Ra90 / 170lm / 30°  
obsahuje zdroj  
IP20 / class I /   
stříbrná  
3000K / 4000K / 6000K



● **LPL043**

materiál: hliník  
LED 3W / WW  
Ra90 / 170lm / 30°  
obsahuje zdroj  
IP20 / class I /   
stříbrná  
3000K / 4000K / 6000K





● **LPL119**

materiál: hliník  
COB LED 5W / WW  
Ra85 / 500lm / 38°  
obsahuje zdroj  
IP20 / class I / **CE**  
bílá  
3000K/4000K/6000K

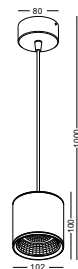

● **LPL120**

materiál: hliník  
COB LED 13W / WW  
Ra85 / 1300lm / 38°  
obsahuje zdroj  
IP20 / class I / **CE**  
bílá  
3000K/4000K/6000K





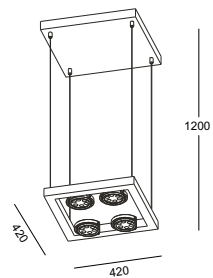

● **LPL046SQ**

materiál : hliník  
LED 24W / WW  
Ra90 / 2400lm / 30°  
obsahuje zdroj  
IP20 / class I / **CE**  
bilá  
3000K/4000K/6000K

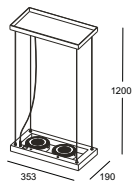

#### ● LPL011

materiál: hliník  
LED 12W / WW  
Ra85 / 1200lm / 30 °  
obsahuje zdroj  
IP20 / class I / CE  
bílá  
3000K/4000K/6000K

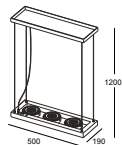

#### ● LPL012

materiál: hliník  
LED 18W / WW  
Ra85 / 1800lm / 30 °  
obsahuje zdroj  
IP20 / class I / CE  
bílá  
3000K/4000K/6000K

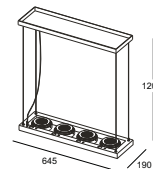

#### ● LPL013

materiál: hliník  
LED 24W / WW  
Ra85 / 2400lm / 30 °  
obsahuje zdroj  
IP20 / class I / CE  
bílá  
3000K/4000K/6000K





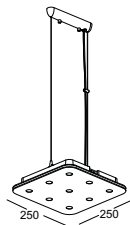

● LPL148

materiál: hliník  
CREE LED 27W / WW  
Ra90 / 1530lm / 6ď  
obsahuje zdroj  
IP20 / class I / CE  
biľa  
3000K/4000K/6000K

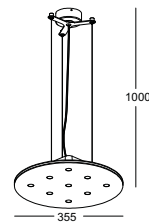

● LPL147

materiál: hliník  
CREE LED 27W / WW  
Ra90 / 1530lm / 6ď  
obsahuje zdroj  
IP20 / class I / CE  
biľa  
3000K/4000K/6000K

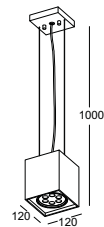

● **LPL139-WT**

materiál: hliník  
CREE LED 12W / WW  
Ra90 / 840lm / 30°  
obsahuje zdroj  
IP20 / class I / **CE**  
bilá  
3000K/4000K/6000K

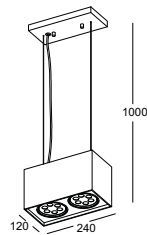

● **LPL140-BK**

materiál: hliník  
CREE LED 24W / WW  
Ra90 / 1680lm / 30°  
obsahuje zdroj  
IP20 / class I / **CE**  
černá  
3000K/ 4000K/6000K

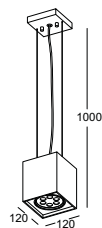

● **LPL139-BK**

materiál: hliník  
CREE LED 12W / WW  
Ra90 / 840lm / 30°  
obsahuje zdroj  
IP20 / class I / **CE**  
černá  
3000K/ 4000K/6000K

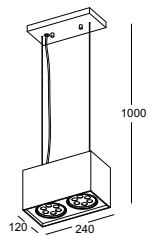

● **LPL140-WT**

materiál: hliník  
CREE LED 24W / WW  
Ra90 / 1680lm / 30°  
obsahuje zdroj  
IP20 / class I / **CE**  
bilá  
3000K/4000K/6000K





#### ● LPL190

materiál: hliník  
 COB LED 5W / WW  
 Ra85 / 500lm / 38°  
 obsahuje zdroj  
 IP20 / class I / **CE**  
 broušená stříbrná  
 3000K/ 4000K/6000K  
 Černý kryt může být vysunut  
 pro tvarování světla



#### ● LPL191

materiál: hliník  
 COB LED 13W / WW  
 Ra85 / 1300lm / 38°  
 obsahuje zdroj  
 IP20 / class I / **CE**  
 broušená stříbrná  
 3000K/ 4000K/6000K  
 Černý kryt může být vysunut  
 pro tvarování světla



● **LPL185**

materiál: hliník  
COB LED 5W / WW  
Ra85 / 500lm / 38°  
obsahuje zdroj  
IP20 / class I / **CE**  
broušená stříbrná  
3000K/4000K/6000K

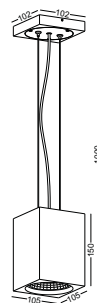

● **LPL186**

materiál: hliník  
COB LED 13W / WW  
Ra85 / 1300lm / 38°  
obsahuje zdroj  
IP20 / class I / **CE**  
broušená stříbrná  
3000K/4000K/6000K

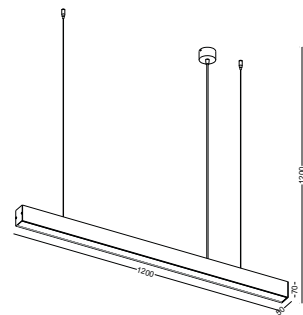

● **LPL159-SL**

materiál : hliník  
SMD LED 20W / WW  
Ra85 / 2000lm /  
obsahuje zdroj  
IP20 / class I / **CE**  
broušená stříbrná  
3000K/4000K/6000K

● **LPL159-WT**

bílá



Jednoduchá řada světel LPL 159 může působit stejná jako mnoho jiných. Stejný hliník, stejný styl, štíhlé tělo lampy. Nicméně, 16W SMD LED dává více než 1600 lumenů, což je stejně jako 32 W zářivka, zatímco spotřeba je poloviční.

LED technologie není jediná úspora těchto světel. V Luxiferu promýšlíme svou konstrukční filozofii v každém aspektu. Naše lampy nešetří jen spotřebou energie, ale i ve spotřebě materiálu při výrobě. Vždy se ujistujeme, že navržené svítidlo je pro svůj účel dostatečné, ale bez nadměrného plýtvání.



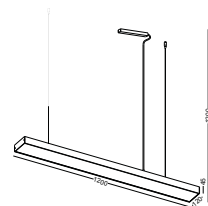

● **LPL160-SL**

materiál: hliník  
 SMD LED 40W / WW  
 Ra85 / 4000lm /  
 obsahuje zdroj  
 IP20 / class I / **CE**  
 broušená stříbrná  
 3000K/4000K/6000K

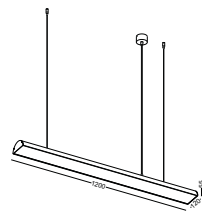

● **LPL161-SL**

materiál: hliník  
 SMD LED 40W / WW  
 Ra85 / 4000lm /  
 obsahuje zdroj  
 IP20 / class I / **CE**  
 broušená stříbrná  
 3000K/4000K/6000K



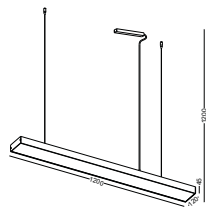

- **LPL160-WT**  
materiál: hliník  
SMD LED 40W / WW  
Ra85 / 4000lm /  
obsahuje zdroj  
IP20 / class I /  $\text{CE}$   
bilá  
3000K / 4000K /  
6000K

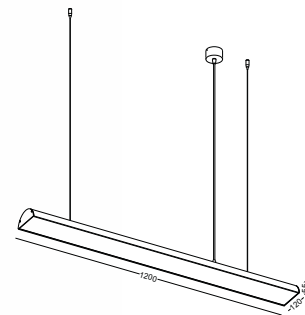

● **LPL161-WT**

materiál: hliník  
SMD LED 40W / WW  
Ra85 / 4000lm /  
obsahuje zdroj  
IP20 / class I / **CE**  
bílá  
3000K/4000K/6000K

● **LPL161-SL**

materiál: hliník  
SMD LED 40W / WW  
Ra85 / 4000lm /  
obsahuje zdroj  
IP20 / class I / **CE**  
broušená stříbrná  
3000K/4000K/6000K





17X27MM, the size defines the lamp is a stylish ZÁVĚSNÁ, the lamp body is extremely compressed to fit a LED dot lamp. A fluorescent lamp will not fit in this size.

However, emaciated body gives astonishing light power, as much as 2400 lumens output, which can light up any application field without any difficulty. For some circumstances like right pictures showing, it is best choice.

- LPL 142  
materiál: hliník LED  
24W / WW  
Ra85 / 2400lm / 30 °  
obsahuje zdroj  
IP20 / class I / CE  
černá  
3000K / 4000K / 6000K

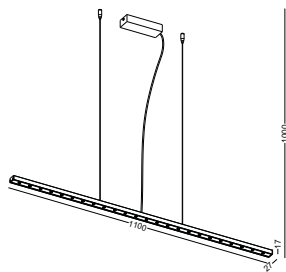



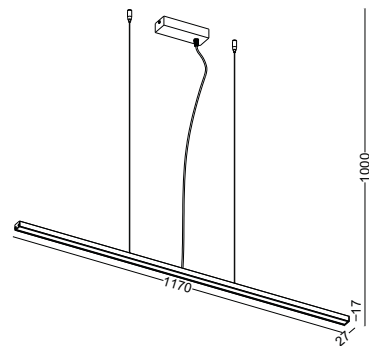

- LPL142A  
materiál: hliník  
LED 24W / WW  
Ra85 / 2400lm  
obsahuje zdroj  
IP20 / class I / **CE**  
černá  
3000K/4000K/6000K  
bez akrylového krytu

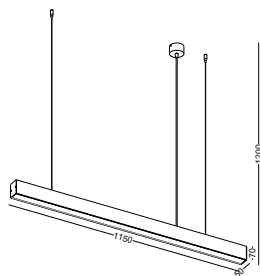

- **LPL159-BK**  
 materiál: hliník  
 SMD 20W / WW  
 Ra80 / 2000lm  
 obsahuje zdroj  
 IP20 / class I / **CE**  
 černá 3000K/ 4000K/  
 6000K  
 akrylový kryt

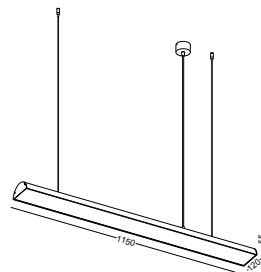

- **LPL161-BK**  
 materiál: hliník  
 SMD 40W / WW  
 Ra80 / 4000lm  
 obsahuje zdroj  
 IP20 / class I / **CE**  
 anodized brushed černá  
 3000K/ 4000K/6000K  
 akrylový kryt

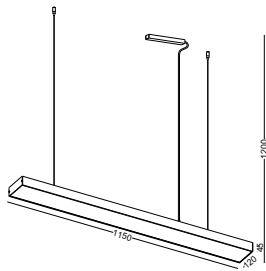

- **LPL160-BK**  
materiál: hliník  
SMD 40W / WW  
Ra80 / 4000lm  
obsahuje zdroj  
IP20 / class I / **CE**  
černá  
3000K/ 4000K/6000K  
akrylový kryt

- **LQL004-BK**  
materiál: hliník  
SMD 40W / WW  
Ra80 / 4000lm  
obsahuje zdroj  
IP20 / class I / **CE**  
černá  
3000K/ 4000K/6000K  
závěsný led panel  
1200x300mm  
kabel 1.2m





● LQL004-SL

materiál: hliník  
SMD 40W / WW  
Ra80 / 4000lm  
obsahuje zdroj  
IP20 / class I / **CE**  
stříbrná  
3000K/ 4000K/6000K  
závěsný led panel  
1200x300mm  
kabel 1.2m



● LQL004-WT

materiál: hliník  
SMD 40W / WW  
Ra80 / 4000lm  
obsahuje zdroj  
IP20 / class I / **CE**  
bílá  
3000K/ 4000K/6000K  
závěsný led panel  
1200x300mm  
kabel 1.2m



- **LPL211**  
materiál: hliník  
ocelové stínitko  
LED 6X6X1W / WW  
Ra85 / 3600lm / 30°  
obsahuje zdroj  
IP20 / class I /   
černá  
3000K/ 4000K/6000K

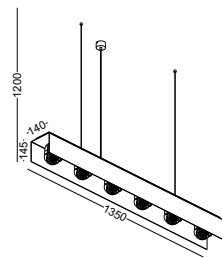

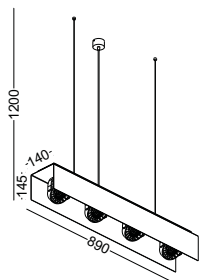

- **LPL210**  
materiál: hliník  
head a steel shade  
LED 4X6X1W / WW  
Ra85 / 2400lm / 30°  
obsahuje zdroj  
IP20 / class I / **CE**  
černá painting 3000K/  
4000K/6000K





CERAMIC SHADE  
LED PEDENTS  
CREE COB 5W  
500LM DIRECT LIGHT  
SPECIAL EDITIONS  
CONSULT WITH SALES  
BEFORE MAKE A ORDER



● **LPL215**  
materiál: keramické  
stínítko s hliníkovým  
chlazením  
COB LED 5W / WW  
Ra85 / 500lm  
obsahuje zdroj  
IP20 / class I / **CE**  
3000K/ 4000K/6000K



● **LPL216**  
materiál: keramické  
stínítko s hliníkovým  
chlazením  
COB LED 5W / WW  
Ra85 / 500lm  
obsahuje zdroj  
IP20 / class I / **CE**  
3000K/ 4000K/6000K



● **LPL217**  
materiál: keramické  
stínítko s hliníkovým  
chlazením  
COB LED 5W / WW  
Ra85 / 500lm  
obsahuje zdroj  
IP20 / class I / **CE**  
3000K/ 4000K/6000K

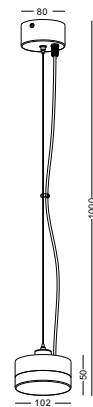

● **LPL206-BK**

materiál: hliník  
Akrylový difuzor  
SMD LED 4W / WW  
Ra80 / 400lm  
obsahuje zdroj  
IP20 / class I / **CE**  
Černá 3000K/ 4000K/  
6000K

● **LPL206-WT**

bílá

● **LPL206-CR**

Chrom

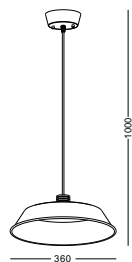

- **LPL162**  
materiál: keramické stínítko s hliníkovým chlazením  
COB LED 9W / WW  
Ra85 / 900lm / obsahuje zdroj  
IP20 / class I / **CE**  
černá  
3000K/ 4000K/6000K

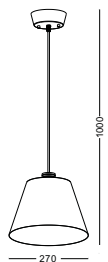

- **LPL164**  
materiál: keramické stínítko s hliníkovým chlazením  
COB LED 9W / WW  
Ra85 / 900lm / obsahuje zdroj  
IP20 / class I / **CE**  
černá  
3000K/ 4000K/6000K



- **LPL163**  
materiál: keramické stínítko s hliníkovým chlazením  
COB LED 9W / WW  
Ra85 / 900lm / obsahuje zdroj  
IP20 / class I / **CE**  
černá  
3000K/ 4000K/6000K

We adopt CREE COB led 9W, which can give 900lm direct light, a Ra85 color rendering index. The difference between this series a competing products is we put the light directly downward without any diffuser, so that it has got the minium light lost a best efficiency. The performance of this light is obviously better than the ones using fluorescent tube or energy-saving lamp.

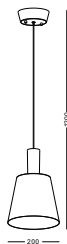

● **LPL222**

materiál: keramické stínítko  
s hliníkovým chlazením  
COB LED 9W / WW  
Ra85 / 900lm /  
obsahuje zdroj  
IP20 / class I / **CE**  
černá  
3000K/ 4000K/6000K

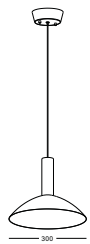

● **LPL223**

materiál: keramické stínítko  
s hliníkovým chlazením  
COB LED 9W / WW  
Ra85 / 900lm /  
obsahuje zdroj  
IP20 / class I / **CE**  
černá  
3000K/ 4000K/6000K



● **LPL221**

materiál: keramické stínítko  
s hliníkovým chlazením  
COB LED 9W / WW  
Ra85 / 900lm /  
obsahuje zdroj  
IP20 / class I / **CE**  
černá  
3000K/ 4000K/6000K













## COB LED HIGHBAY 20/30W SVÍTIVOST 2000/3000 LM CRYSTAL SHADE

Používáme CREE COB 1512 20W,  
se svitem 2000 lm přímého světla s  
indexem podání barev Ra85.

Rozdíl mezi tímto a jinými svítidly je v  
přímém svitu, bez použití  
difuzoru, tedy s minimální ztrátou  
světla. Výkon je výrazně lepší, než u  
zářivek či úsporných žárovek.

Zákazník se může zvolit vyšší výkon  
až 30W, kde použijeme CREE COB  
2520, s 3000 lm na výstupu.

Možné jsou dvě varianty stínítek -  
krystalické a ocelové v mnoha  
barvách, s možností úprav barev dle  
přání zákazníka.

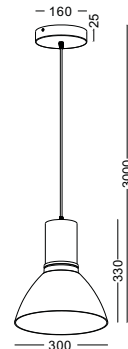

- **LPL301**  
materiál: hliník  
krystalické stínítko  
CREE COB 20W / WW  
Ra85 / 1800lm / 38°  
obsahuje zdroj  
IP40 / class I / **CE**  
stříbrná  
3000K/4000K/6000K

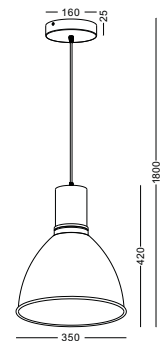

- **LPL302 OCEL**  
ocelové stínítko



COB LED HIGHBAY  
AŽ 20/30W  
2000/3000LM  
OCELOVÉ STÍNÍTKO

● LPL302-BK

materiál: hliník  
Ocelové stínítko  
CREE COB 20W / WW  
Ra85 / 1800lm /38°  
obsahuje zdroj  
IP40 / class I / **CE**  
Černá  
3000K/4000K/6000K



● LPL302-BK

materiál: hliník  
Ocelové stínítko  
CREE COB 20W / WW  
Ra85 / 1800lm /38°  
obsahuje zdroj  
IP40 / class I / **CE**  
bílá  
3000K/4000K/6000K



*COB LED HIGHBAY  
AŽ 20/30W  
2000/3000LM  
OCELOVÉ STÍNÍTKO  
V BARVÁCH*

● LPL302-RD  
červená



● LPL302-YW  
žlutá



● LPL302-GN  
zelená









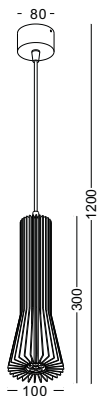

- **LPL152-BK**  
materiál: hliník  
CREE LED 6W / WW  
Ra90 / 732lm / 30stupňů  
obsahuje zdroj  
IP20 / class I / **CE**  
černá  
3000K/ 4000K/ 6000K

- **LPL152-WT**

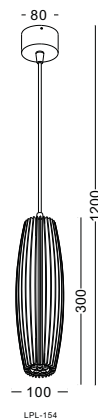

- **LPL154-BK**  
materiál: hliník  
CREE LED 6W / WW  
Ra90 / 732lm / 30stupňů  
obsahuje zdroj  
IP20 / class I / **CE**  
černá  
3000K/ 4000K/ 6000K

- **LPL154-WT**  
bílá

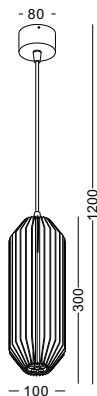

- **LPL153-BK**  
materiál: hliník  
CREE LED 6W / WW  
Ra90 / 732lm / 30stupňů  
obsahuje zdroj  
IP20 / class I / **CE**  
černá  
3000K/ 4000K/ 6000K

- **LPL153-WT coated**  
white

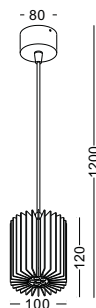

- **LPL155-BK**  
materiál: hliník  
CREE LED 6W / WW  
Ra90 / 732lm / 30stupňů  
obsahuje zdroj  
IP20 / class I / **CE**  
černá  
3000K/ 4000K/ 6000K

- **LPL155-WT**  
coated white



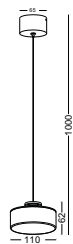

- **LPL176**
- materiál: hliník
- COB LED 5W / WW
- Ra85 / 500lm /
- obsahuje zdroj
- IP20 / class I / **CE**
- akrylové stínítko
- stříbrná
- 3000K/4000K/6000K

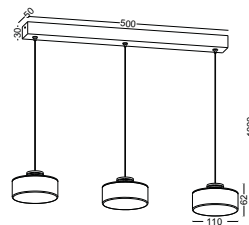

- **LPL177**
- materiál: hliník
- COB LED 3x5W / WW
- Ra85 / 1500lm /
- obsahuje zdroj
- IP20 / class I / **CE**
- akrylové stínítko
- stříbrná
- 3000K/4000K/6000K







● **LPL174**

materiál: hliník  
COB LED 5W / WW  
Ra85 / 500lm /  
obsahuje zdroj  
IP20 / class I / **CE**  
akrylové stínítko  
stříbrná  
3000K/4000K/6000K

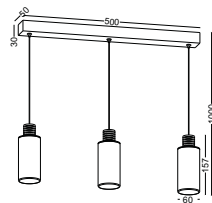

● **LPL175**

materiál: hliník  
COB LED 3x5W / WW  
Ra85 / 1500lm /  
obsahuje zdroj  
IP20 / class I / **CE**  
akrylové stínítko  
stříbrná  
3000K/4000K/6000K



- **LPL236**  
materiál: hliník  
COB LED 5W / WW  
Ra85 / 500lm /  
obsahuje zdroj  
IP20 / class I / **CE**  
akrylové stínítko  
černá  
3000K/4000K/6000K



- **LPL237**  
materiál: hliník  
COB LED 5W / WW  
Ra85 / 500lm /  
obsahuje zdroj  
IP20 / class I / **CE**  
akrylové stínítko  
černá  
3000K/4000K/6000K



- **LPL238**  
materiál: hliník  
COB LED 5W / WW  
Ra85 / 500lm /  
obsahuje zdroj  
IP20 / class I / **CE**  
akrylové stínítko  
černá  
3000K/4000K/6000K



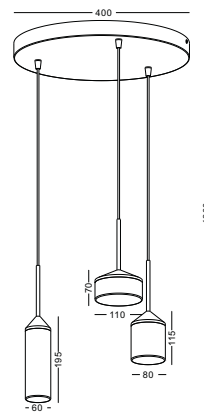

● **LPL239**

materiál: hliník  
COB LED 3x5W / WW  
Ra85 / 1500lm /  
obsahuje zdroj  
IP20 / class I /  $\text{CE}$   
akrylové stínítko  
černá  
3000K/4000K/6000K





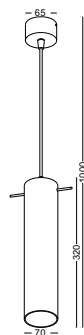

- **LPL156**  
 materiál: hliník  
 COB LED 5W / WW  
 Ra85 / 500lm / 38stupňů  
 obsahuje zdroj  
 IP20 / class I / **CE**  
 skleněné stínítko  
 stříbrná  
 3000K/4000K/6000K

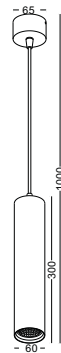

- **LPL157**  
 materiál: hliník  
 COB LED 5W / WW  
 Ra85 / 500lm / 38stupňů  
 obsahuje zdroj  
 IP20 / class I / **CE**  
 stříbrná  
 3000K/4000K/ 6000K



- **LPL187**  
materiál: hliník  
CREE LED 3W / WW  
Ra90 / 170lm /  
obsahuje zdroj  
IP20 / class I / **CE**  
akrylové stínitko  
černá  
3000K/4000K/6000K

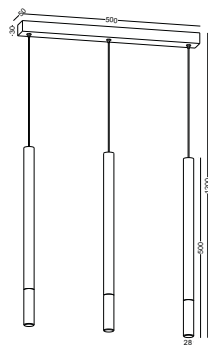

- **LPL188**  
materiál: hliník  
CREE LED 3x3W / WW  
Ra90 / 510lm /  
obsahuje zdroj  
IP20 / class I / **CE**  
akrylové stínitko černá  
3000K/4000K/6000K



- **LPL202**  
materiál: hliník  
SMD LED 4.5W / WW  
Ra80 / 450lm /  
obsahuje zdroj  
IP20 / class I / **CE**  
akrylové stínítko  
stříbrná  
3000K/4000K/6000K

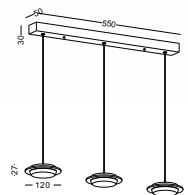

- **LPL203**  
materiál: hliník  
SMD LED 3x4.5W / WW  
Ra80 / 1350lm /  
obsahuje zdroj  
IP20 / class I / **CE**  
akrylové stínítko  
stříbrná  
3000K/ 4000K/6000K

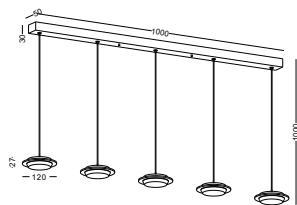

- **LPL204**  
materiál: hliník  
SMD LED 5x4.5W / WW  
Ra80 / 2250lm /  
obsahuje zdroj  
IP20 / class I / **CE**  
akrylové stínítko  
stříbrná  
3000K/ 4000K/6000K

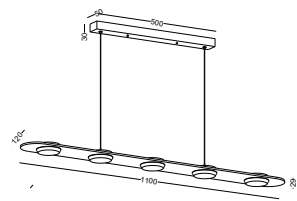

- **LPL205**  
materiál: hliník  
SMD LED 5x4.5W / WW  
Ra80 / 2250lm /  
obsahuje zdroj  
IP20 / class I / **CE**  
akrylové stínítko  
stříbrná  
3000K/ 4000K/6000K

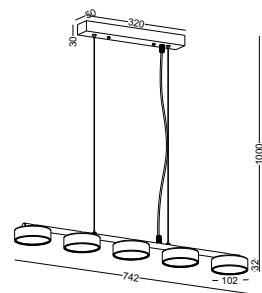

- LPL194
- materiál: hliník
- SMD LED 5x4.5W / WW
- Ra80 / 2250lm /
- obsahuje zdroj
- IP20 / class I /  $\text{CE}$
- akrylové stínitko
- Chrom
- 3000K/ 4000K/6000K



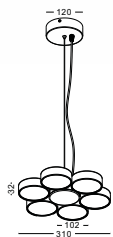

- **LPL193**  
materiál: hliník  
SMD LED 27W / WW  
Ra80 / 2700lm /  
obsahuje zdroj  
IP20 / class I / **CE**  
akrylové stínitko  
Chrom  
3000K/ 4000K/

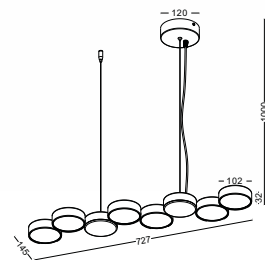

- **LPL195**  
materiál: hliník  
SMD LED 27W / WW  
Ra80 / 2700lm /  
obsahuje zdroj  
IP20 / class I / **CE**  
akrylové stínitko  
Chrom  
3000K/ 4000K/

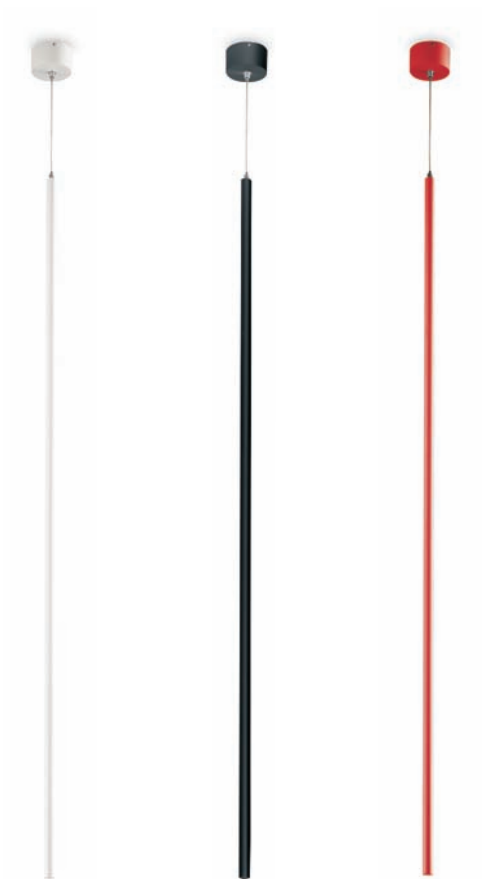

● *LPL201-WT*

materiál: hliník  
CREE LED 1W / WW  
Ra80 / 122lm /30 stupňů  
obsahuje zdroj  
IP20 / class I / **CE**  
bílá  
3000K/ 4000K/ 6000K

● *LPL201-BK*

černá

● *LPL201-RD*

červená



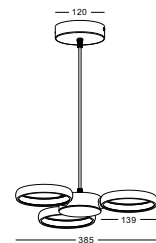

- **LPL196**  
 materiál: hliník  
 CREE LED 18W / WW  
 Ra80 / 1800lm  
 obsahuje zdroj  
 IP20 / class I / **CE**  
 chrom  
 3000K/ 4000K/6000K

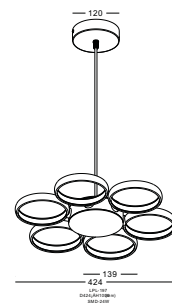

- **LPL197**  
 materiál: hliník  
 LED 18W / WW  
 Ra80 / 1800lm  
 obsahuje zdroj  
 IP20 / class I / **CE**  
 chrom  
 3000K/4000K/6000K

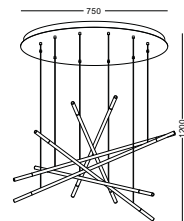

● **LPL251**

materiál: hliník  
CREE LED 12W / WW  
Ra85 / 1464lm  
obsahuje zdroj  
IP20 / class I / CE  
Akrylový difuzor  
ocelová základna  
3000K/4000K/6000K

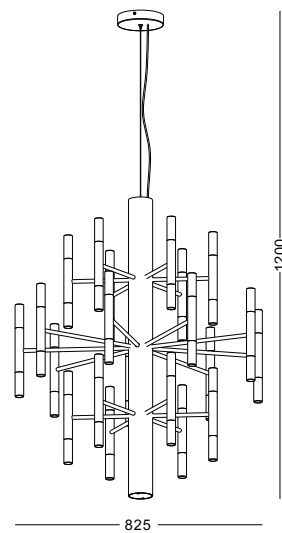

- **LPL214-BK**  
materiál: hliník  
Akrylový difuzor  
LED 42X3W / WW  
Ra85 / 7140lm  
obsahuje zdroj  
IP20 / class I / **CE**  
Černá  
3000K/ 4000K/ 6000K







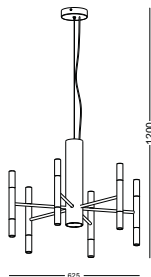

● **LPL212-BK**  
 materiál : hliník  
 Akrylový difuzor  
 LED 12X3W / WW  
 Ra85/2040lm  
 obsahuje zdroj  
 IP20 / class I / **CE**  
 Černá  
 3000K/ 4000K/ 6000K

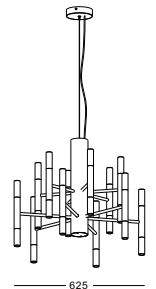

● **LPL213-BK**  
 materiál : hliník  
 Akrylový difuzor  
 LED 24X3W / WW  
 Ra85/4080lm  
 obsahuje zdroj  
 IP20 / class I / **CE**  
 Černá  
 3000K/ 4000K/ 6000K

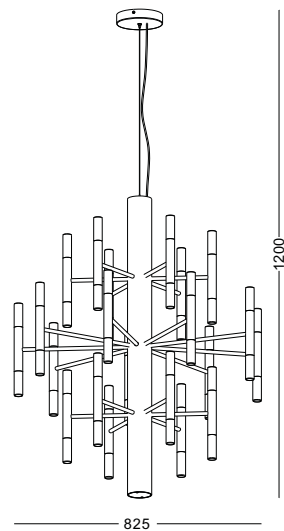

- **LPL214-WT**  
materiál: hliník  
Akrylový difuzor  
LED 42X3W / WW  
Ra85 / 7140lm  
obsahuje zdroj  
IP20 / class I / **CE**  
bílá 3000K/4000K/6000K

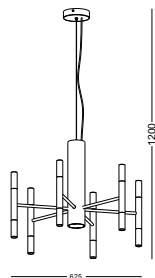

- **LPL212-WT**
- materiál: hliník
- Akrylový difuzor
- LED 12X3W / WW
- Ra85 / 2040lm
- obsahuje zdroj
- IP20 / class I / **CE**
- bílá
- 3000K/4000K/6000K

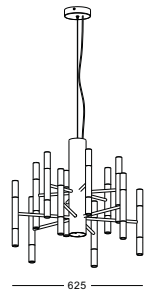

- **LPL213-BK**
- materiál: hliník
- Akrylový difuzor
- LED 24X3W / WW
- Ra85 / 4080lm
- obsahuje zdroj
- IP20 / class I / **CE**
- bílá
- 3000K/4000K/6000K

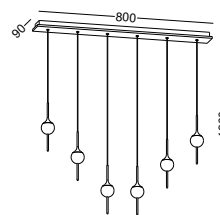
**LPL243**

materiál: hliník  
CREE LED 6x3W / WW  
Ra85 / 1020lm  
obsahuje zdroj  
IP20 / class I / CE  
Akrylový difuzor  
Ocelová základna  
3000K/4000K/6000K

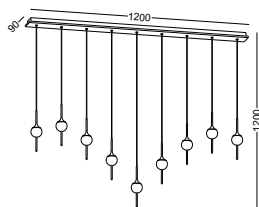

● LPL244

materiál: hliník  
CREE LED 9x3W / WW  
Ra85 / 1530lm  
obsahuje zdroj  
IP20 / class I / **CE**  
Akrylový difuzor  
Ocelová základna  
3000K/4000K/6000K







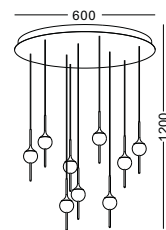

● **LPL245**

materiál: hliník  
CREE LED 9x3W / WW  
Ra85 / 1530lm  
obsahuje zdroj  
IP20 / class I / **CE**  
Akrylový difuzor  
Ocelová základna  
3000K/4000K/6000K



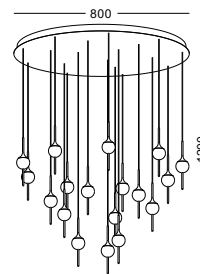

● LPL246

materiál: hliník  
CREE LED 18x3W / WW  
Ra85 / 3060lm  
obsahuje zdroj  
IP20 / class I / CE  
Akrylový difúzor  
Ocelová základna  
3000K/4000K/6000K



● **LPL252**

materiál: hliník  
SMD 24W / WW  
Ra80 / 2000lm  
obsahuje zdroj  
IP20 / class I / **CE**  
černá 3000K/4000K/  
6000K

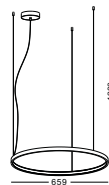

● **LPL253**

materiál: hliník  
SMD 30W / WW  
Ra80 / 3000lm  
obsahuje zdroj  
IP20 / class I / **CE**  
černá  
3000K/4000K/ 6000K

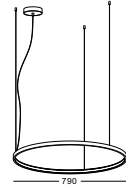

● **LPL254**

materiál: hliník  
SMD 36W / WW  
Ra80 / 3600lm  
obsahuje zdroj  
IP20 / class I / **CE**  
černá  
3000K/4000K/ 6000K

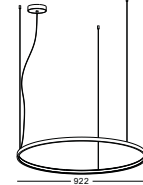

● **LPL255**

materiál: hliník  
SMD 42W / WW  
Ra80 / 4200lm  
obsahuje zdroj  
IP20 / class I / **CE**  
černá  
3000K/4000K/ 6000K

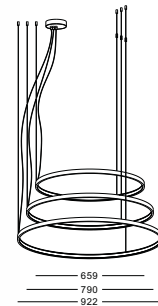

- **LPL256**  
materiál: hliník  
SMD 42+36+30W / WW  
Ra80 / 10800lm  
obsahuje zdroj  
IP20 / class I / CE  
černá  
3000K/ 4000K/6000K

# LED STROPNÍ SVÍTIDLA





● LBL104

materiál: hliník  
 LED 4.5W / WW  
 Ra90 / 450lm / 120°  
 obsahuje zdroj  
 IP20 / class I / CE  
 bílá

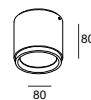

● LBL105

materiál: hliník  
 LED 9W / WW  
 Ra90 / 900lm / 120°  
 obsahuje zdroj  
 IP20 / class I / CE  
 bílá

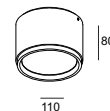

● LBL106

materiál: hliník  
 LED 20W / WW  
 Ra90 / 2000lm / 120°  
 obsahuje zdroj  
 IP20 / class I / CE

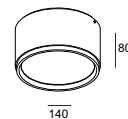

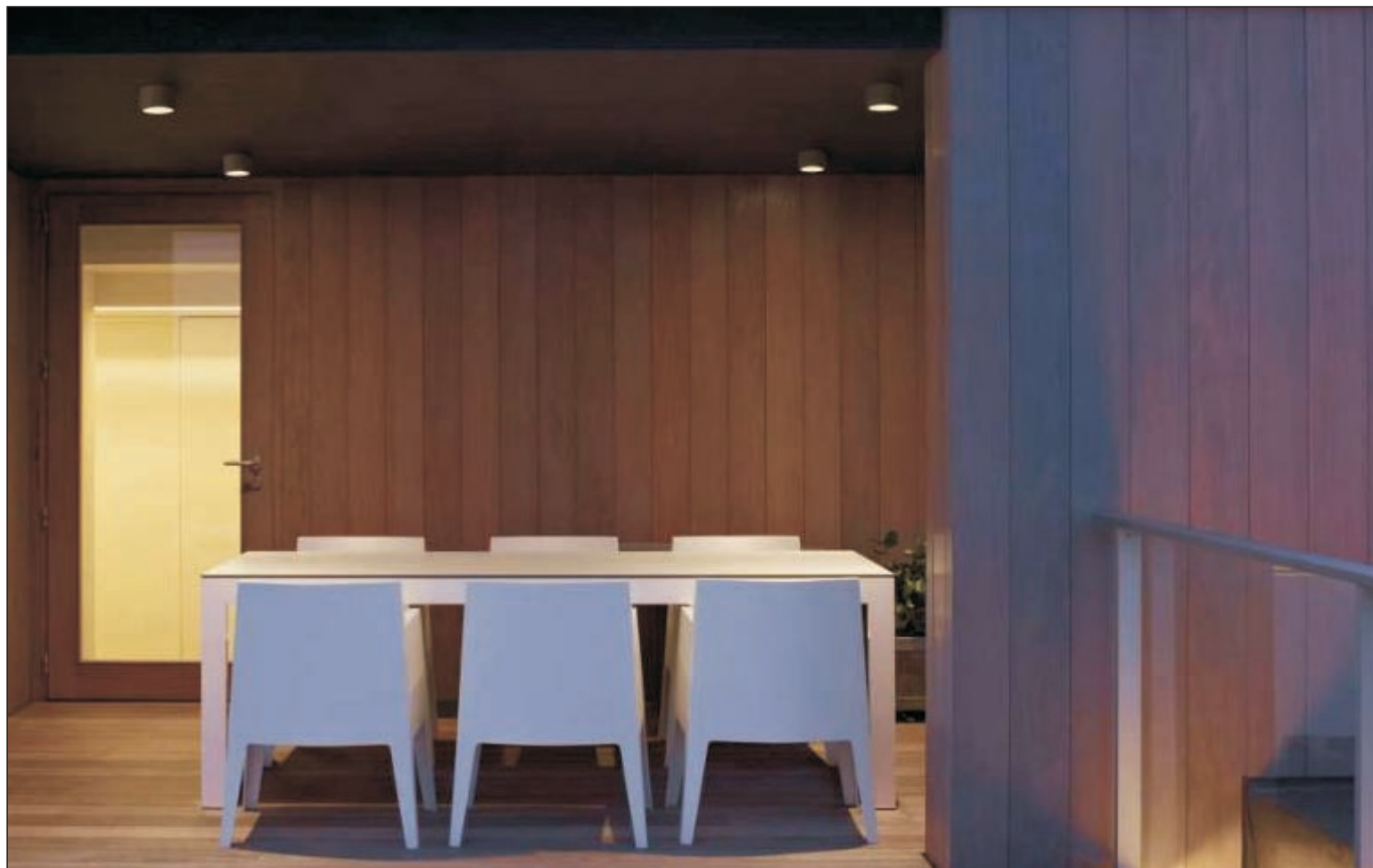

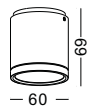

- **LBL135**  
materiál: hliník  
COB LED 5W / WW  
Ra85 / 500lm / 38°  
obsahuje zdroj  
IP20 / class I / **CE**  
černá  
3000k/4000k/6000k

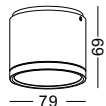

- **LBL136**  
materiál: hliník  
COB LED 9W / WW  
Ra85 / 900lm / 38°  
obsahuje zdroj  
IP20 / class I / **CE**  
černá  
3000k/4000k/6000k

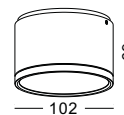

- **LBL137**  
materiál: hliník  
COB LED 13W / WW  
Ra85 / 1300lm / 38°  
obsahuje zdroj  
IP20 / class I / **CE**  
černá  
3000k/4000k/6000k





- **LBL207**  
materiál: hliník  
COB LED 5W / WW  
Ra85 / 500lm  
obsahuje zdroj  
IP40 / class I / CE  
stříbrná  
3000k/4000k/6000k

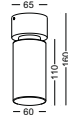

- **LBL208**  
materiál: hliník  
COB LED 5W / WW  
Ra85 / 500lm  
obsahuje zdroj  
IP40 / class I / CE  
stříbrná  
3000k/4000k/6000k



- **LBL209**  
materiál: hliník  
COB LED 5W / WW  
Ra85 / 500lm  
obsahuje zdroj  
IP40 / class I / CE  
stříbrná  
3000k/4000k/6000k

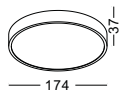

- **LBL201-WT**  
materiál: hliník  
SMD LED 12W / WW  
Ra85 / 1200lm /  
obsahuje zdroj  
IP40 / class II / **CE**  
bílá  
3000k/4000k/6000k

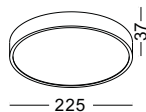

- **LBL202-WT**  
materiál: hliník  
SMD LED 18W / WW  
Ra85 / 1800lm /  
obsahuje zdroj  
IP40 / class II / **CE**  
bílá  
3000k/4000k/6000k

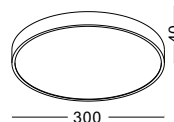

- **LBL203-WT**  
materiál: hliník  
SMD LED 24W / WW  
Ra85 / 2400lm /  
obsahuje zdroj  
IP40 / class II / **CE**  
bílá  
3000k/4000k/6000k

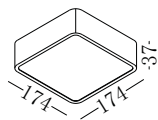

- **LBL204-WT**  
materiál: hliník  
SMD LED 12W / WW  
Ra85 / 1200lm /  
obsahuje zdroj  
IP40 / class II / **CE**  
bílá  
3000k/4000k/6000k

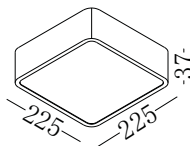

- **LBL205-WT**  
materiál: hliník  
SMD LED 18W / WW  
Ra85 / 1800lm /  
obsahuje zdroj  
IP40 / class II / **CE**  
bílá  
3000k/4000k/6000k

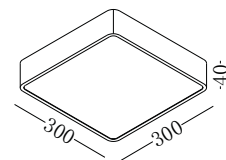

- **LBL206-WT**  
materiál: hliník  
SMD LED 24W / WW  
Ra85 / 2400lm /  
obsahuje zdroj  
IP40 / class II / **CE**  
bílá  
3000k/4000k/6000k

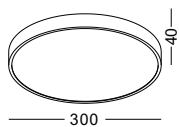

- **LBL203-BK**  
materiál: hliník  
SMD LED 24W / WW  
Ra85 / 2400lm /  
obsahuje zdroj  
IP40 / class II / **CE**  
černá  
3000k/4000k/6000k

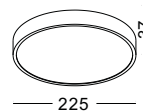

- **LBL202-BK**  
materiál: hliník  
SMD LED 18W / WW  
Ra85 / 1800lm /  
obsahuje zdroj  
IP40 / class II / **CE**  
černá  
3000k/4000k/6000k

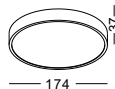

- **LBL201-BK**  
materiál: hliník  
SMD LED 12W / WW  
Ra85 / 1200lm /  
obsahuje zdroj  
IP40 / class II / **CE**  
černá  
3000k/4000k/6000k

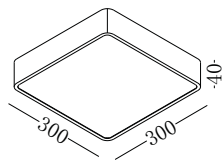

- **LBL206-BK**  
materiál: hliník  
SMD LED 24W / WW  
Ra85 / 2400lm /  
obsahuje zdroj  
IP40 / class II / **CE**  
černá  
3000k/4000k/6000k

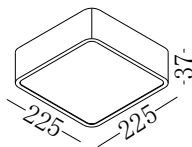

- **LBL205-BK**  
materiál: hliník  
SMD LED 18W / WW  
Ra85 / 1800lm /  
obsahuje zdroj  
IP40 / class II / **CE**  
černá  
3000k/4000k/6000k

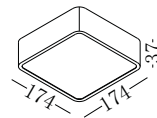

- **LBL204-BK**  
materiál: hliník  
SMD LED 12W / WW  
Ra85 / 1200lm /  
obsahuje zdroj  
P40 / class II / **CE**  
černá  
3000k/4000k/6000k



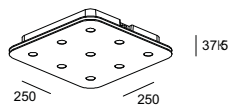

● **LBL083**

materiál: hliník LED  
27W / WW  
Ra90 / 1530lm / 120°  
obsahuje zdroj  
IP20 / class I / CE  
bilá

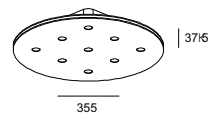

● **LBL084**

materiál: hliník LED  
27W / WW  
Ra90 / 1530lm / 120°  
obsahuje zdroj  
IP20 / class I / CE  
bilá



- **LBL048-BK**  
materiál: hliník  
CREE LED 6W / WW  
Ra90 / 732lm / 30°  
obsahuje zdroj  
IP20 / class I / **CE**  
černá  
3000k/4000k/6000k

- **LBL048-WT**  
materiál: hliník  
CREE LED 6W / WW  
Ra90 / 732lm / 30°  
obsahuje zdroj  
IP20 / class I / **CE**  
bílá  
3000k/ 4000k/6000k



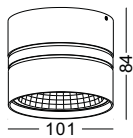

- **LBL112**  
materiál: hliník  
COB LED 9W / WW  
Ra85 / 900lm / 38°  
obsahuje zdroj  
IP20 / class I / **CE**  
broušená stříbrná  
3000k/4000k/6000k

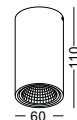

- **LBL 118**  
materiál: hliník  
COB LED 5W / WW  
Ra85 / 500lm / 38°  
obsahuje zdroj  
IP20 / class I / **CE**  
stříbrná  
3000k/4000k/6000k



- **LBL 119**  
materiál: hliník  
COB LED 9W / WW  
Ra85 / 500lm / 38°  
obsahuje zdroj  
IP20 / class I / **CE**  
stříbrná  
3000k/4000k/6000k

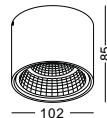

- **LBL 120**  
materiál: hliník  
COB LED 13W / WW  
Ra85 / 1300lm / 38°  
obsahuje zdroj  
IP20 / class I / **CE**  
stříbrná  
3000k/4000k/6000k



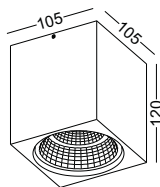

- **LBL111-SL**  
materiál: hliník  
COB LED 13W / WW  
Ra85 / 1300lm / 38°  
obsahuje zdroj  
IP20 / class I / **CE**  
broušená stříbrná  
3000k/4000k/6000k
- **LBL111-WT**  
bílá
- **LBL111-BK**  
broušená černá

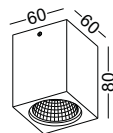

- **LBL110-SL**  
materiál: hliník  
COB LED 5W / WW  
Ra85 / 500lm / 38°  
obsahuje zdroj  
IP20 / class I / **CE**  
broušená stříbrná  
3000k/4000k/6000k
- **LBL110-WT**  
bílá
- **LBL110-BK**  
broušená černá

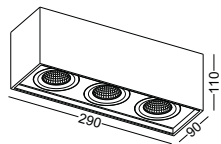

- **LBL175**  
materiál: hliník  
COB LED 15W / WW  
Ra85 / 1500lm / 38°  
obsahuje zdroj  
IP20 / class I / **CE**  
bilá  
3000k/4000k/6000k

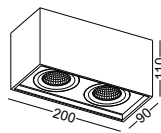

- **LBL174**  
materiál: hliník  
COB LED 10W / WW  
Ra85 / 1000lm / 38°  
obsahuje zdroj  
IP20 / class I / **CE**  
bilá  
3000k/4000k/6000k

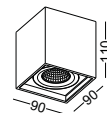

- **LBL173**  
materiál: hliník  
COB LED 5W / WW  
Ra85 / 500lm / 38°  
obsahuje zdroj  
IP20 / class I / **CE**  
bilá  
3000k/ 4000k/6000k





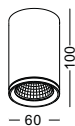

- **LBL049**  
materiál: hliník  
COB LED 5W / WW  
Ra85 / 500lm / 38°  
obsahuje zdroj  
IP20 / class I / **CE**  
bílá  
3000k/ 4000k/6000k

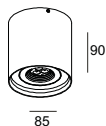

- **LBL054**  
materiál: hliník  
CREE LED 3W / WW  
Ra90 / 366lm / 30°  
obsahuje zdroj  
IP20 / class I / **CE**  
bílá  
3000k/ 4000k/6000k



- **LDC013**  
materiál: hliník  
LED 3W / WW  
Ra85 / 300lm / 30°  
obsahuje zdroj  
IP20 / class I / **CE**  
černá  
3000k/ 4000k/ 6000k



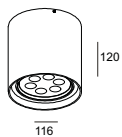

- **LBL057**  
materiál: hliník  
CREE LED 6W / WW  
Ra90 / 732lm / 30°  
obsahuje zdroj  
IP20 / class I / **CE**  
bilá  
3000k/ 4000k/6000k

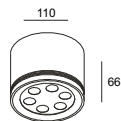

- **LBL602**  
materiál: hliník  
LED 6W / WW  
Ra85 / 600lm / 30°  
obsahuje zdroj  
IP20 / class I / **CE**  
stříbrná  
3000k/ 4000k/ 6000k

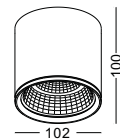

- **LBL050**  
materiál: hliník  
COB LED 9W / WW  
Ra85 / 900lm / 38°  
obsahuje zdroj  
IP20 / class I / **CE**  
bilá  
3000k/ 4000k/6000k



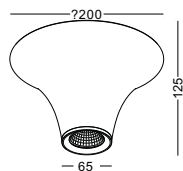

● **LBL052**  
 materiál: hliník  
 COB LED 5W / WW  
 Ra85 / 500lm / 38°  
 obsahuje zdroj  
 IP20 / class I / **CE**  
 bilá  
 3000k/4000k/6000k

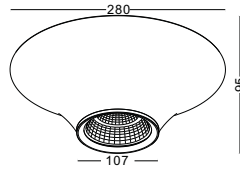

● **LBL052**  
 materiál: hliník  
 COB LED 13W / WW  
 Ra85 / 1300lm / 38°  
 obsahuje zdroj  
 IP20 / class I / **CE**  
 bilá  
 3000k/4000k/6000k

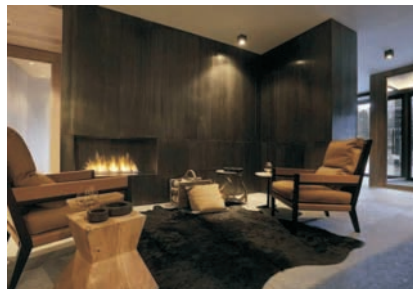

● <i>LBL001</i>	materiál: hliník	LED 1X3W / WW	Ra90 / 170lm / 30	obsahuje zdroj	IP20 / class I / D90 Š90 H100
● <i>LBL002</i>	materiál: hliník	LED 2X3W / WW	Ra90 / 732lm / 30	obsahuje zdroj	IP20 / class I / D200 Š90 H100
● <i>LBL003</i>	materiál: hliník	LED 3X3W / WW	Ra90 / 732lm / 30	obsahuje zdroj	IP20 / class I / D290 Š90 H100
● <i>LBL031</i>	materiál: hliník	LED 3X1W / WW	Ra80 / 732lm / 30	obsahuje zdroj	IP20 / class I / D90 Š90 H100
● <i>LBL032</i>	materiál: hliník	LED 6X1W / WW	Ra80 / 732lm / 30	obsahuje zdroj	IP20 / class I / D200 Š90 H100
● <i>LBL033</i>	materiál: hliník	LED 12X1W / WW	Ra80 / 732lm / 30	obsahuje zdroj	IP20 / class I / D290 Š90 H100





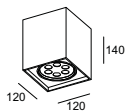

- **LBL074-WT**  
materiál: hliník  
LED 12W / WW  
Ra90 / 840lm / 30 °  
obsahuje zdroj  
IP20 / class I /   
bílá

- **LBL074-BK**  
černá

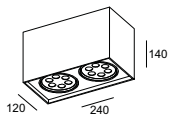

- **LBL075-WT**  
materiál: hliník  
LED 24W / WW  
Ra90 / 1680lm / 30 °  
obsahuje zdroj  
IP20 / class I /   
bílá

- **LBL075-BK**  
černá



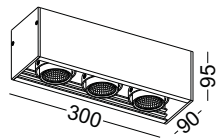

- **LBL108-3-SL**  
materiál: hliník  
COB LED 3X5W / WW  
Ra85 / 1500lm / 38°  
obsahuje zdroj  
IP20 / class I / CE  
broušená stříbrná  
a černé boky  
3000k/ 4000k/6000k

- **LBL108-3-WT**  
kompletně bílá

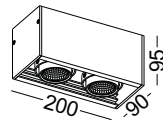

- **LBL108-2-SL**  
materiál: hliník  
COB LED 2X5W / WW  
Ra85 / 1000lm / 38°  
obsahuje zdroj  
IP20 / class I / CE  
broušená stříbrná  
a černé boky  
3000k/ 4000k/6000k

- **LBL108-2-WT**  
kompletně bílá



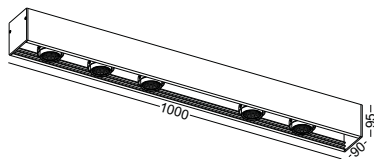

- **LBL 108-5-SL**  
 materiál: hliník  
 COB LED 5X5W / WW  
 Ra85 / 2500lm / 38°  
 obsahuje zdroj  
 IP20 / class I / **CE**  
 broušená stříbrná  
 a černé boky  
 3000k/ 4000k/6000k
- **LBL 108-3-WT**  
 kompletně bílá

*There is big difference between this series a other surface mounted spot lights, that is the lighting head could be moved freely along the hliník extrusion. The light could be turned a moved ,it helps to light objects in unfixed position. It shows like a surface mounted downlight, but it functions like a track a several track lights.*

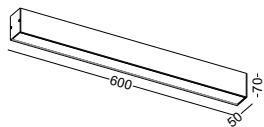

● **LBL115-SL**  
materiál: hliník  
SMD LED 10W / WW  
Ra85 / 1000lm  
obsahuje zdroj  
IP20 / class I / **CE**  
broušená stříbrná  
3000k/ 4000k/6000k

● **LBL115-WT**  
materiál: hliník  
SMD LED 10W / WW  
Ra85 / 1000lm  
obsahuje zdroj  
IP20 / class I / **CE**  
bílá  
3000k/ 4000k/6000k

● **LBL115-BK**  
materiál: hliník  
SMD LED 10W / WW  
Ra85 / 1000lm  
obsahuje zdroj  
IP20 / class I / **CE**  
broušená černá  
3000k/4000k/6000k

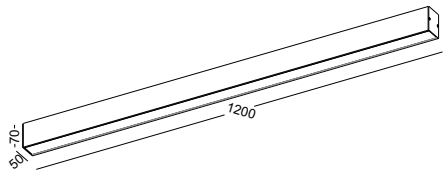

● **LBL116-WT**

materiál: hliník  
SMD LED 20W / WW  
Ra85 / 2000lm  
obsahuje zdroj  
IP20 / class I / **CE**  
bílá  
3000k/ 4000k/6000k

● **LBL116-SL**

broušená stříbrná

● **LBL116-BK**

broušená černá





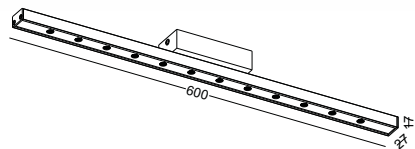

● **LBL117**

materiál: hliník  
 CREE LED 12W / WW  
 Ra90 / 1464lm / 30°  
 obsahuje zdroj  
 IP20 / class I / **CE**  
 černá  
 3000k/4000k/6000k

*17X27MM, the size defines the lamp is a stylish ZÁVĚSNÁ, the lamp body is extremely compressed to fit a LED dot lamp. A flulrescent lamp will not fitin this size.*



NEJNIŽŠÍ POVRCHOVĚ MONTOVANÉ STROPNÍ SVÍTIDLO.  
UŽÍVANÉ PRO KUCHYŇĚ, NÁBYTEK A JINÉ PROSTORY  
S MALÝM PROSTOREM



- **LBL095**  
materiál: hliník  
LED 3W / WW  
Ra90 / 366lm / 30°  
obsahuje zdroj  
IP20 / class I / **CE**  
černé sklo, chrom

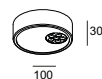

- **LBL098**  
materiál: hliník  
LED 6W / WW  
Ra90 / 732lm / 30°  
obsahuje zdroj  
IP20 / class I / **CE**  
bílé sklo, chrom

- **LBL096**  
materiál: hliník  
LED 3W / WW  
Ra90 / 366lm / 30°  
obsahuje zdroj  
IP20 / class I / **CE**  
bílé sklo, chrom

- **LBL099**  
materiál: hliník  
LED 6W / WW  
Ra90 / 732lm / 30°  
obsahuje zdroj  
IP20 / class I / **CE**  
bílé sklo, chrom





STYLOVÉ POVRCHOVÉ  
MONTOVANÉ SVÍTIDLO.  
OTOČNÁ HLAVA,  
ČOČKY LZE VYUŽÍT  
JAKO BODOVÁ SVÍTIDLA

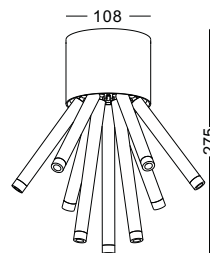

● LBL162-WT

materiál: hliník  
CREE LED 9W / WW  
Ra90 / 1098lm / 30°  
obsahuje zdroj  
IP20 / class I / CE  
bílá  
3000K/4000K/6000K

● LBL162-BK

● černá  
3000K/4000K/6000K



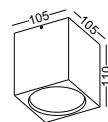

- **LBL172-BK**  
materiál: hliník  
SMD LED 10W / WW  
Ra80 / 1000lm / 30°  
obsahuje zdroj  
IP20 / class I / **CE**  
akrylový kryt  
broušená černá  
3000K/4000K/6000K
- **LBL172-SL**  
broušená stříbrná  
3000K/4000K/6000K

# LED LUSTRY



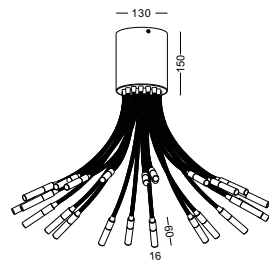

- LBL143
- materiál: hliník
- CREE LED 24X1W / WW
- Ra80 / 2400lm /
- obsahuje zdroj
- IP20 / class I / CE
- chromová hlava
- akrylový difuzor
- 3000k/ 4000k/6000k





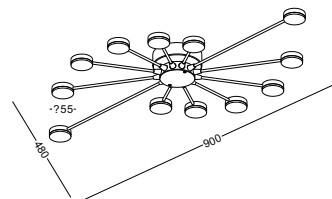

- **LBL169**  
materiál: hliník  
CREE LED 12X3W / WW  
Ra85 / 2040lm /  
obsahuje zdroj  
IP20 / class I / **CE**  
černá  
akrylový difuzor  
3000k/ 4000k/6000k

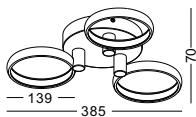

● **LBL 139**

materiál: hliník  
SMD LED 3X6W / WW  
Ra80 / 1800lm /  
obsahuje zdroj  
IP20 / class I /  $\text{C}\text{E}$   
chrom  
akrylový difuzor  
3000k/ 4000k/6000k

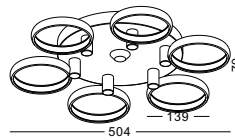

● **LBL 140**

materiál: hliník  
SMD LED 6X6W / WW  
Ra80 / 3600lm /  
obsahuje zdroj  
IP20 / class I /  $\text{C}\text{E}$   
chrom  
akrylový difuzor  
3000k/ 4000k/6000k





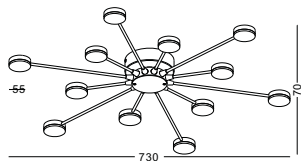

● **LBL168**

materiál: hliník  
 CREE LED 12X3W / WW  
 Ra85 / 2040lm /  
 obsahuje zdroj  
 IP20 / class I / CE  
 černá

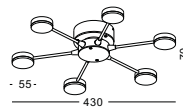

● **LBL167**

materiál: hliník  
 CREE LED 6X3W / WW  
 Ra85 / 1020lm /  
 obsahuje zdroj  
 IP20 / class I / CE  
 černá

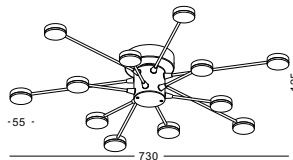

- **LBL170**  
materiál: hliník  
CREE LED 12X3W / WW  
Ra85 / 2040lm /  
obsahuje zdroj  
IP20 / class I / CE  
černá

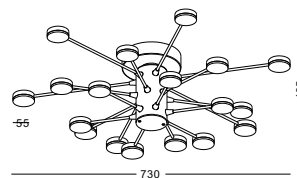

- **LBL171**  
materiál: hliník  
CREE LED 18X3W / WW  
Ra85 / 3060lm  
obsahuje zdroj  
IP20 / class I / CE  
černá

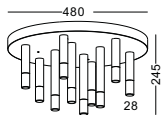

● **LBL158**

materiál: hliník  
 Akrylový difuzor  
 CREE LED 10X3W / WW  
 Ra90 / 1700lm /  
 obsahuje zdroj  
 IP20 / class I / **CE**  
 černá hlava  
 a ocelová základna  
 3000k/4000k/ 6000k

*It will be the beginning of  
 passun's series of chaelier.  
 We will got many more in the  
 next season a this lamp will  
 be a symbol.  
 This series has got the same  
 design philosophy,simple a  
 round lamp,the base mirrors the  
 light back into the ground a  
 45W cree lamp give lots of light  
 but the arcylic shade looks soft  
 a elegant.*

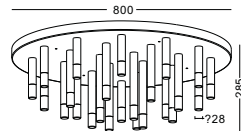

● **LBL159**

materiál: hliník  
 Akrylový difuzor  
 CREE LED 24X3W / WW  
 Ra90 / 4080lm /  
 obsahuje zdroj  
 IP20 / class I / **CE**  
 černá hlava  
 a ocelová základna  
 3000k/4000k/ 6000k

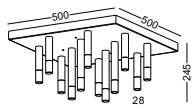

● **LBL160**

materiál: hliník  
 Akrylový difuzor  
 CREE LED 12X3W / WW  
 Ra90 / 2040lm /  
 obsahuje zdroj  
 IP20 / class I / **CE**  
 černá hlava  
 a ocelová základna  
 3000k/4000k/ 6000k

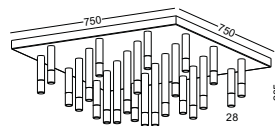

● **LBL161**

materiál: hliník  
 Akrylový difuzor  
 CREE LED 24X3W / WW  
 Ra90 / 4080lm /  
 obsahuje zdroj  
 IP20 / class I / **CE**  
 černá hlava  
 a ocelová základna  
 3000k/4000k/ 6000k

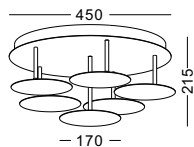

- **LBL 165**  
materiál: matná ocel  
nepřímé osvětlení  
SMD 6X6W / WW  
Ra80 / 3600lm /  
obsahuje zdroj  
IP20 / class I /  $\text{CE}$   
bílá  
3000k/4000k/6000k

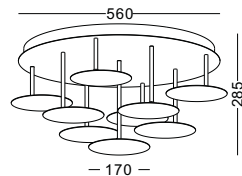

- **LBL 166**  
materiál: matná ocel  
nepřímé osvětlení  
SMD 9X6W / WW  
Ra80 / 5400lm /  
obsahuje zdroj  
IP20 / class I /  $\text{CE}$   
bílá  
3000k/4000k/6000k

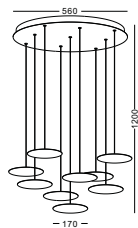

● **LPL241**

materiál: matná ocel  
 nepřímé osvětlení  
 SMD 9X6W / WW  
 Ra80 / 5400lm /  
 obsahuje zdroj  
 IP20 / class I / **CE**  
 bílá, transparentní kabely  
 3000k/ 4000k/6000k

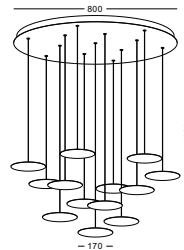

● **LPL242**

materiál: matná ocel  
 nepřímé osvětlení  
 SMD 13X6W / WW  
 Ra80 / 7800lm /  
 obsahuje zdroj  
 IP20 / class I / **CE**  
 bílá, transparentní kabely  
 3000k/ 4000k/6000k

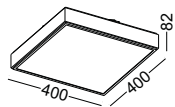
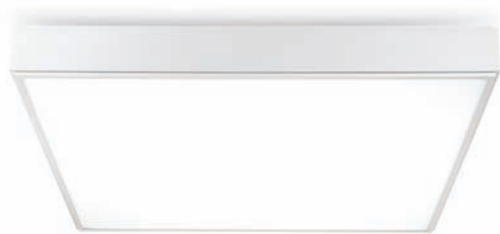

● **LBL151**

materiál: hliník  
 SMD LED 24W / WW  
 Ra80 / 2400lm /  
 obsahuje zdroj  
 IP20 / class I / CE  
 bílá, akrylový difuzor  
 3000k/ 4000k/6000k

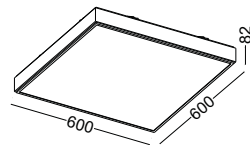
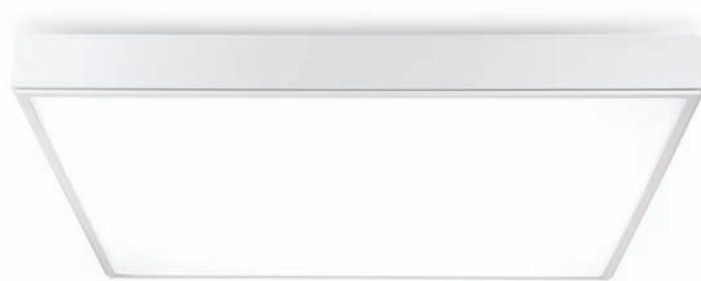

● **LBL152**

materiál: hliník  
 SMD LED 42W / WW  
 Ra80 / 4200lm /  
 obsahuje zdroj  
 IP20 / class I / CE  
 bílá, akrylový difuzor  
 3000k/ 4000k/6000k



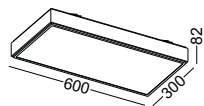
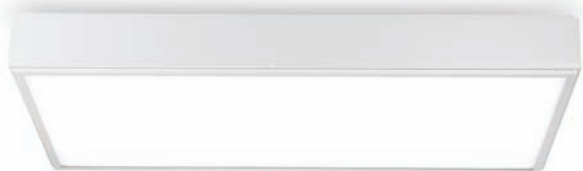

- **LBL150**  
materiál: hliník  
SMD LED 24W / WW  
Ra80 / 2400lm /  
obsahuje zdroj  
IP20 / class I / CE  
bílá, akrylový difuzor  
3000k/ 4000k/6000k

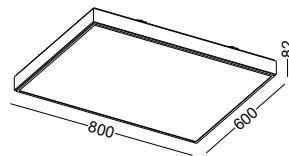
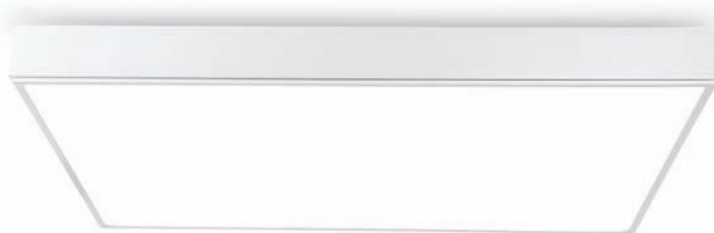

- **LBL153**  
materiál: hliník  
SMD LED 54W / WW  
Ra80 / 5400lm /  
obsahuje zdroj  
IP20 / class I / CE  
bílá, akrylový difuzor  
3000k/ 4000k/6000k

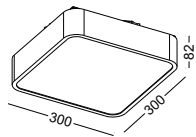

- **LBL146**  
materiál: hliník  
SMD LED 12W / WW  
Ra80 / 1200lm /  
obsahuje zdroj  
IP20 / class I /  $\text{CE}$   
broušená stříbrná,  
akrylový difuzor  
3000k/4000k/ 6000k

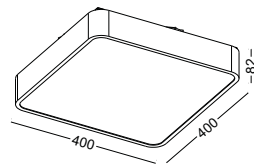

- **LBL147**  
materiál: hliník  
SMD LED 24W / WW  
Ra80 / 2400lm /  
obsahuje zdroj  
IP20 / class I /  $\text{CE}$   
broušená stříbrná,  
akrylový difuzor  
3000k/4000k/ 6000k

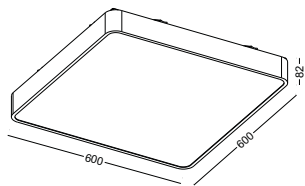

- **LBL148**  
materiál: hliník  
SMD LED 42W / WW  
Ra80 / 4200lm /  
obsahuje zdroj  
IP20 / class I / **CE**  
broušená stříbrná,  
akrylový difuzor  
3000k/4000k/ 6000k

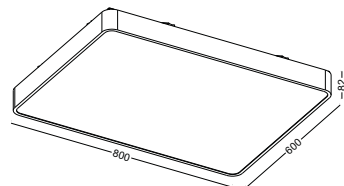

- **LBL149**  
materiál: hliník  
SMD LED 54W / WW  
Ra80 / 5400lm /  
obsahuje zdroj  
IP20 / class I / **CE**  
broušená stříbrná,  
akrylový difuzor  
3000k/4000k/ 6000k

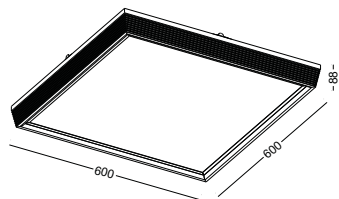

● **LBL156**  
materiál: hliník  
SMD LED 42W / WW  
Ra80 / 4200lm /  
obsahuje zdroj  
IP20 / class I / **CE**  
broušená černá,  
akrylový difuzor  
3000k/4000k/ 6000k

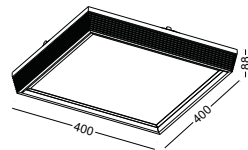

● **LBL155**  
materiál: hliník  
SMD LED 21W / WW  
Ra80 / 2100lm /  
obsahuje zdroj  
IP20 / class I / **CE**  
broušená černá,  
akrylový difuzor  
3000k/4000k/ 6000k

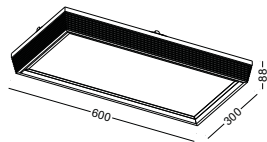

- **LBL154**  
materiál: hliník  
SMD LED 24W / WW  
Ra80 / 2400lm /  
obsahuje zdroj  
IP20 / class I /  $\text{CE}$   
broušená černá,  
akrylový difuzor  
3000k/4000k/ 6000k

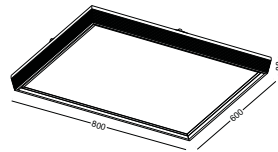

- **LBL157**  
materiál: hliník  
SMD LED 54W / WW  
Ra80 / 5400lm /  
obsahuje zdroj  
IP20 / class I /  $\text{CE}$   
broušená černá,  
akrylový difuzor  
3000k/4000k/ 6000k

# LED POVRCHOVÁ BODOVÁ SVÍTIDLA





- **HI8107**  
materiál: hliník  
LED 3W / WW  
Ra85 / 300lm / 30°  
obsahuje zdroj  
IP20 / class I / **CE**  
stříbrná  
3000k/ 4000k/ 6000K

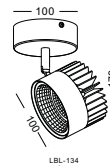

- **LBL134**  
materiál: hliník  
COB LED 13W / WW  
Ra85 / 1300lm / 38°  
obsahuje zdroj  
IP20 / class I / **CE**  
stříbrná  
a chromová  
základna  
3000k/4000k/6000k





- **HLSP001**  
materiál: hliník  
LED 3W / WW  
Ra85 / 300lm / 30°  
obsahuje zdroj  
IP20 / class I / **CE**  
stříbrná  
3000k/4000k/6000k



- **LSP9011**  
materiál: hliník  
CREE LED 3W / WW  
Ra90 / 366lm / 30°  
obsahuje zdroj  
IP20 / class I / **CE**  
stříbrná a černá  
3000k/4000k/6000k

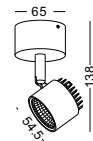

- **LBL132**  
materiál: hliník  
COB LED 5W / WW  
Ra85 / 500lm / 38°  
obsahuje zdroj  
IP20 / class I / **CE**  
stříbrná  
3000k/4000k/6000k



● **LBL080**

materiál: hliník  
 LED 18W / WW  
 Ra90 / 1020lm / 30°  
 bez zdroje 18W  
 IP20 / class III/ **CE**  
 černá  
 průměr výřezu - 55MM  
 3000k/4000k/ 6000k

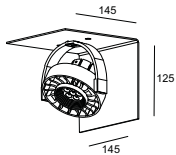

● **LBL081**

materiál: hliník  
 LED 36W / WW  
 Ra90 / 2040lm / 30°  
 bez zdroje 2X18W  
 IP20 / class III/ **CE**  
 černá  
 průměr výřezu - 180X50MM  
 3000k/4000k/ 6000k

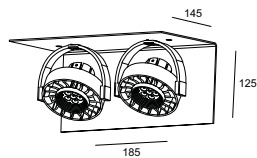

● **LBL082**

materiál: hliník  
 LED 54W / WW  
 Ra90 / 3060lm / 30°  
 bez zdroje 3X18W  
 IP20 / class III/ **CE**  
 černá  
 průměr výřezu - 320X50MM  
 3000k/4000k/ 6000k

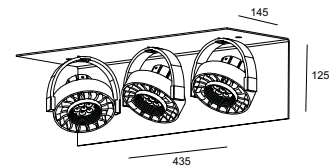

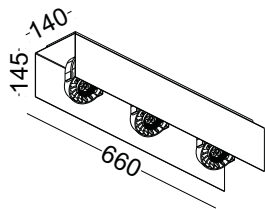
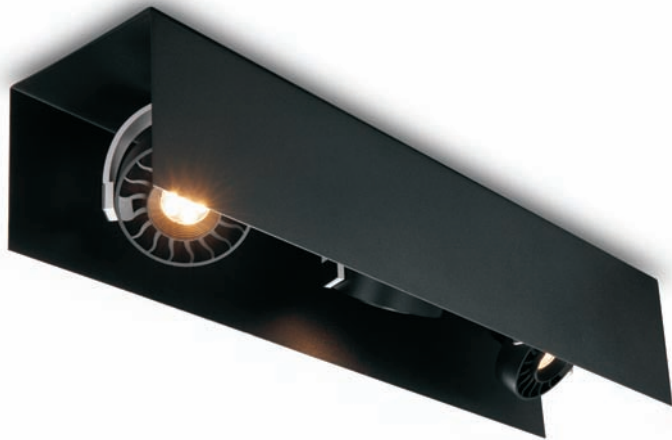

- LSP162  
materiál: hliník,  
ocelové stínítko  
LED 18W / WW  
Ra80 / 1800lm / 30°  
obsahuje zdroj  
IP20 / class I / CE  
černá  
3000k/4000k/6000k

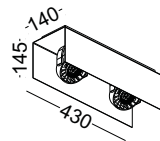

- LSP161  
materiál: hliník  
ocelové stínítko  
LED 12W / WW  
Ra80 / 1200lm / 30°  
obsahuje zdroj  
IP20 / class I / CE  
černá  
3000k/4000k/6000k



- **LBL079**  
materiál: hliník  
LED 54W / WW  
Ra90 / 3060lm / 30°  
obsahuje zdroj 3X18W  
IP20 / class I / **CE**  
bílá a černá  
3000k/4000k/6000k

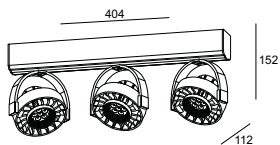

- **LBL078**  
materiál: hliník  
LED 36W / WW  
Ra90 / 2040lm / 30°  
obsahuje zdroj 2X18W  
IP20 / class I / **CE**  
bílá a černá  
3000k/4000k/6000k

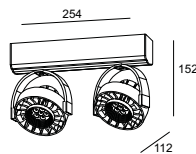

- **LBL077**  
materiál: hliník  
CREE LED 18W / WW  
Ra90 / 1020lm / 30°  
obsahuje zdroj  
IP20 / class I / **CE**  
bílá a černá  
3000k/4000k/6000k

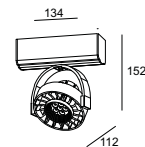







● **LSP073**

materiál: hliník  
 LED 18W / WW  
 Ra85 / 1800lm / 30°  
 obsahuje zdroj 18W  
 IP20 / class I/CE  
 biľá  
 3000k/ 4000k/6000k

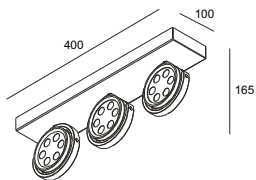

● **LSP072**

materiál: hliník  
 LED 12W / WW  
 Ra90 / 1200lm / 30°  
 obsahuje zdroj 12W  
 IP20 / class I/CE  
 biľá  
 3000k/ 4000k/6000k

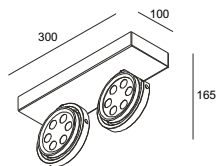

● **LSP071**

materiál: hliník  
 LED 6W / WW  
 Ra90 / 600lm / 30°  
 obsahuje zdroj 6W  
 IP20 / class I/CE  
 biľá  
 3000k/ 4000k/6000k

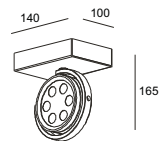



- **HL8088-BK**  
materiál: hliník  
LED 3W / WW  
Ra80 / 300lm / 30°  
obsahuje zdroj  
IP20 / class II / **CE**  
černá  
3000k/ 4000k/ 6000k



- **HL8088-SL**  
materiál: hliník  
LED 3W / WW  
Ra80 / 300lm / 30°  
obsahuje zdroj  
IP20 / class II / **CE**  
stříbrná  
3000k/4000k/ 6000k



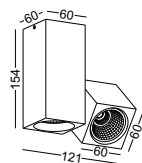

- **LBL121**  
 materiál: hliník  
 COB LED 2X5W / WW  
 Ra85 / 1000lm / 38°  
 obsahuje zdroj  
 IP20 / class I / **CE**  
 stříbrná, černá  
 3000k/ 4000k/6000k

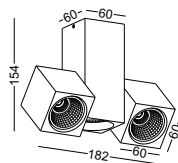

- **LBL122**  
 materiál: hliník  
 COB LED 3X5W / WW  
 Ra85 / 1500lm / 38°  
 obsahuje zdroj  
 IP20 / class I / **CE**  
 stříbrná a černá  
 3000k/ 4000k/6000k

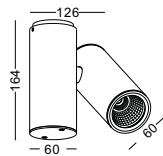

- **LBL125**  
 materiál: hliník  
 COB LED 5W / WW  
 Ra85 / 500lm / 38°  
 obsahuje zdroj  
 IP20 / class I / **CE**  
 bílá  
 3000k/4000k/6000k

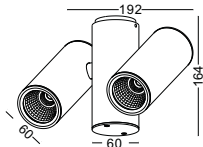

- **LBL126**  
 materiál: hliník  
 COB LED 2x5W / WW  
 Ra85 / 1000lm / 38°  
 obsahuje zdroj  
 IP20 / class I / **CE**  
 bílá  
 3000k/ 4000k/6000k

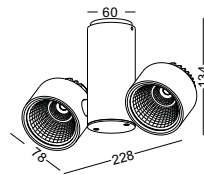

- **LBL128**  
 materiál: hliník  
 COB LED 2x9W / WW  
 Ra85 / 1800lm / 38°  
 obsahuje zdroj  
 IP20 / class I / **CE**  
 bílá  
 3000k/ 4000k/6000k

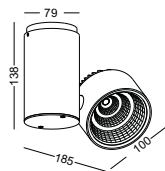

- **LBL129**  
 materiál: hliník  
 COB LED 13W / WW  
 Ra85 / 1300lm / 38°  
 obsahuje zdroj  
 IP20 / class I / **CE**  
 bílá  
 3000k/4000k/6000k

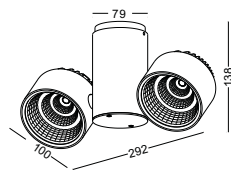

- **LBL130**  
 materiál: hliník  
 COB LED 2x13W / WW  
 Ra85 / 2600lm / 38°  
 obsahuje zdroj  
 IP20 / class I / **CE**  
 bílá  
 3000k/ 4000k/6000k

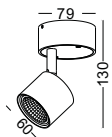

- **LBL123**  
 materiál: hliník  
 COB LED 5W / WW  
 Ra85 / 500lm / 38°  
 obsahuje zdroj  
 IP20 / class I / **CE**  
 stříbrná  
 3000k/4000k/6000k

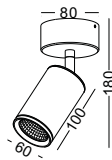

- **LBL051**  
 materiál: hliník  
 COB LED 5W / WW  
 Ra85 / 500lm / 38°  
 obsahuje zdroj  
 IP20 / class I / **CE**  
 bílá  
 3000k/4000k/6000k

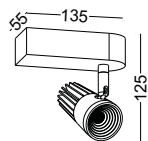

- LSP159
- materiál: hliník
- CREE XML 10W / WW
- Ra85 / 900lm / 30°
- obsahuje zdroj
- IP20 / class I / **CE**
- černá
- 3000k/4000k/6000k

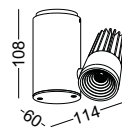

- LSP160
- materiál: hliník
- CREE XML 10W / WW
- Ra85 / 900lm / 30°
- obsahuje zdroj
- IP20 / class I / **CE**
- černá
- 3000k/4000k/6000k

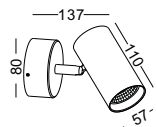

- **LWA187-WT**  
materiál: hliník  
COB LED 5W / WW  
Ra85 / 500lm / 38°  
obsahuje zdroj  
IP20 / class I / CE  
bilá  
3000k/4000k/6000k

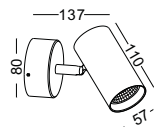

- **LWA187-BK**  
materiál: hliník  
COB LED 5W / WW  
Ra85 / 500lm / 38°  
obsahuje zdroj  
IP20 / class I / CE  
Černá  
3000k/4000k/6000k



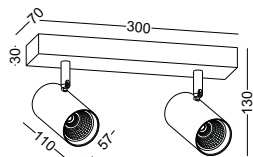

- LSP164-WT
- materiál: hliník
- COB LED 2X5W / WW
- Ra85 / 1000lm / 38°
- obsahuje zdroj
- IP20 / class I / CE
- bílá
- 3000k/ 4000k/ 6000k

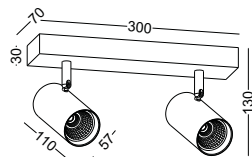

- LSP164-BK
- materiál: hliník
- COB LED 2X5W / WW
- Ra85 / 1000lm / 38°
- obsahuje zdroj
- IP20 / class I / CE
- černá
- 3000k/4000k/6000k



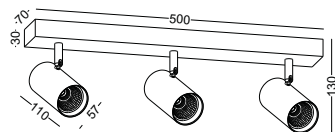

- **LSP165-WT**  
 materiál: hliník  
 COB LED 3X5W / WW  
 Ra85 / 1500lm / 38°  
 obsahuje zdroj  
 IP20 / class I / CE  
 bílá  
 3000k/ 4000k/ 6000k

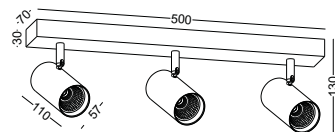

- **LSP165-BK**  
 materiál: hliník  
 COB LED 3X5W / WW  
 Ra85 / 1500lm / 38°  
 obsahuje zdroj  
 IP20 / class I / CE  
 černá  
 3000k/4000k/6000k

# LED TRACK SYSTEM



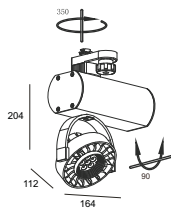

● **LSP103**

materiál: hliník  
 CREE LED 18W / WW  
 Ra90 / 1020lm / 30°  
 obsahuje zdroj  
 IP20 / class I / **CE**  
 bílá  
 3000K/4000K/6000K  
 pro 3 fázový systém

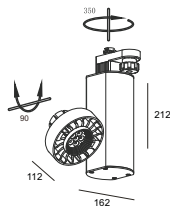

● **LSP104**

materiál: hliník  
 LED 18W / WW /  
 Ra90 / 1020lm / 30°  
 obsahuje zdroj  
 IP20 / class I / **CE**  
 bílá  
 3000K/4000K/6000K  
 pro 3 fázový systém

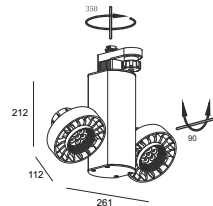

● **LSP105**

materiál: hliník  
 LED CREE 36W / WW /  
 Ra90 / 2040lm / 30°  
 obsahuje zdroj  
 IP20 / class I / **CE**  
 bílá  
 3000K/4000K/6000K  
 pro 3 fázový systém

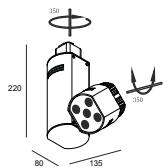

#### ● LSP146

materiál: hliník  
CREE LED 15W / WW /  
Ra90 / 850lm / 30°  
obsahuje zdroj  
IP20 / class I /  $\text{CE}$   
bílá  
3000K/4000K/6000K  
pro 3 fázový systém

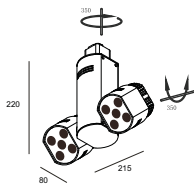

#### ● LSP147

materiál: hliník  
CREE LED 30W / WW /  
Ra90 / 1700lm / 30°  
obsahuje zdroj  
IP20 / class I /  $\text{CE}$   
bílá  
3000K/4000K/6000K  
pro 3 fázový systém

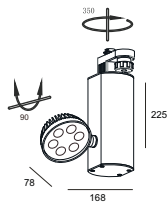

● LSP151

materiál: hliník  
 LED 12W / WW  
 Ra90 / 720lm / 30°  
 obsahuje zdroj  
 IP20 / class I / CE  
 bílá  
 3000K/4000K/6000K  
 pro 3 fázový systém

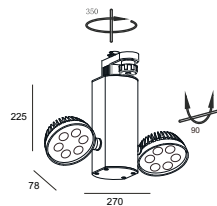

● LSP152

materiál: hliník  
 LED 24W / WW  
 Ra90 / 1440lm / 30°  
 obsahuje zdroj  
 IP20 / class I / CE  
 bílá  
 3000K/4000K/6000K  
 pro 3 fázový systém



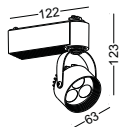

● LSP106

materiál: hliník  
LED 3W / WW  
Ra85 / 300lm / 30°  
obsahuje zdroj  
IP20 / class II /  $\text{CE}$   
bílá  
3000K/ 4000K/6000K  
pro 2 fázový systém

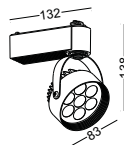

● LSP108

materiál: hliník  
LED 6W / WW  
Ra85 / 600lm / 30°  
obsahuje zdroj  
IP20 / class II /  $\text{CE}$   
bílá  
3000K/ 4000K/6000K  
pro 2 fázový systém

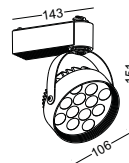

● LSP110

materiál: hliník  
LED 12W / WW  
Ra85 / 1200lm / 30°  
obsahuje zdroj  
IP20 / class II /  $\text{CE}$   
bílá  
3000K/4000K/6000K  
pro 2 fázový systém



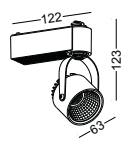

### ● LSP111

materiál: hliník  
 COB LED 5W / WW  
 Ra85 / 500lm / 38°  
 obsahuje zdroj  
 IP20 / class II / **CE**  
 bílá  
 3000K/ 4000K/6000K  
 pro 2 fázový systém



### ● LSP112

materiál: hliník  
 COB LED 9W / WW  
 Ra85 / 900lm / 38°  
 obsahuje zdroj  
 IP20 / class II / **CE**  
 bílá  
 3000K/4000K/6000K  
 pro 2 fázový systém

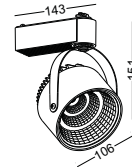

### ● LSP113

materiál: hliník  
 COB LED 13W / WW  
 Ra85 / 1300lm / 38°  
 obsahuje zdroj  
 IP20 / class II / **CE**  
 bílá  
 3000K/ 4000K/6000K  
 pro 2 fázový systém

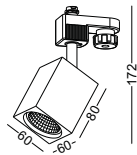

● LSP134

materiál: hliník  
 COB LED 5W / WW  
 Ra85 / 500lm / 38°  
 obsahuje zdroj  
 IP20 / class I / **CE**  
 bílá  
 3000K/4000K/6000K  
 pro 3 fázový systém

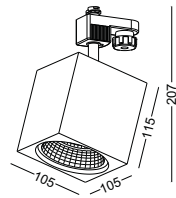

● LSP135

materiál: hliník  
 COB LED 13W / WW  
 Ra85 / 1300lm / 38°  
 obsahuje zdroj  
 IP20 / class I / **CE**  
 bílá  
 3000K/4000K/6000K  
 pro 3 fázový systém

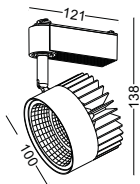

- **LSP125**  
materiál: hliník  
COB LED 13W / WW  
Ra85 / 1300lm / 38°  
obsahuje zdroj  
IP20 / class II   
bilá  
3000K/ 4000K/6000K  
pro 2 fázový systém

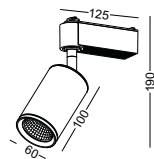

- **LSP114**  
materiál: hliník  
COB LED 5W / WW  
Ra85 / 500lm / 38°  
obsahuje zdroj  
IP20 / class II   
bilá  
3000K/ 4000K/6000K  
pro 2 fázový systém







TRACK SYSTEM

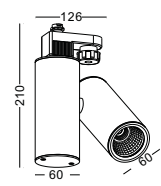

● **LSP115**  
 materiál: hliník  
 COB LED 5W / WW  
 Ra85 / 500lm / 38°  
 obsahuje zdroj  
 IP20 / class I / **CE**  
 bílá  
 3000K/4000K/6000K  
 pro 3 fázový systém

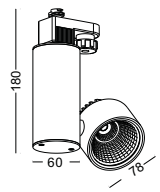

● **LSP118**  
 materiál: hliník  
 COB LED 9W / WW  
 Ra85 / 900lm / 38°  
 obsahuje zdroj  
 IP20 / class I / **CE**  
 bílá  
 3000K/4000K/6000K  
 pro 3 fázový systém

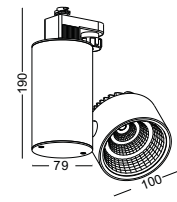

● **LSP120**  
 materiál: hliník  
 COB LED 13W / WW  
 Ra85 / 1300lm / 38°  
 obsahuje zdroj  
 IP20 / class I / **CE**  
 bílá  
 3000K/4000K/6000K  
 pro 3 fázový systém

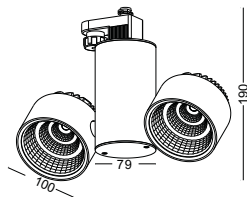

● LSP121

materiál: hliník  
 COB LED 26W / WW  
 Ra85 / 2600lm / 38°  
 obsahuje zdroj  
 IP20 / class I / **CE**  
 bílá  
 3000K/4000K/6000K  
 pro 3 fázový systém

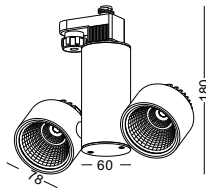

● LSP119

materiál: hliník  
 COB LED 18W / WW  
 Ra85 / 1800lm / 38°  
 obsahuje zdroj  
 IP20 / class I / **CE**  
 bílá  
 3000K/4000K/6000K  
 pro 3 fázový systém

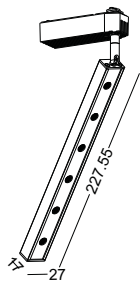

- LSP123  
materiál: hliník  
LED 6W / WW  
Ra85 / 600lm / 30°  
obsahuje zdroj  
IP20 / class II / CE  
černá  
3000K/4000K/6000K  
pro 2 fázový systém

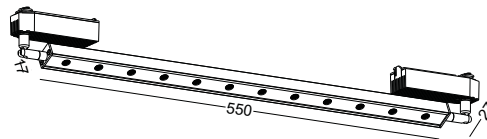

- LSP124  
materiál: hliník  
LED 12W / WW  
Ra85 / 1200lm / 30°  
obsahuje zdroj  
IP20 / class II / CE  
černá  
3000K/ 4000K/ 6000K  
pro 2 fázový systém



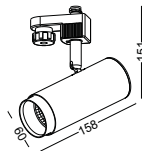

### ● LSP117

materiál: hliník  
 COB LED 5W / WW  
 Ra85 / 500lm / 38°  
 obsahuje zdroj  
 IP20 / class I / **CE**  
 bílá  
 3000K/ 4000K/6000K  
 pro 3 fázový systém



### ● LSP122

materiál: hliník  
 COB LED 13W / WW  
 Ra85 / 1300lm / 38°  
 obsahuje zdroj  
 IP20 / class I / **CE**  
 bílá  
 3000K/ 4000K/6000K  
 pro 3 fázový systém





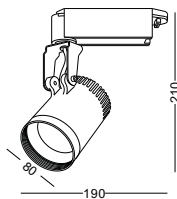

● **LSP202**

materiál: hliník  
 CREE COB 1512 18W / WW  
 Ra85 / 1800lm / 24°  
 obsahuje zdroj  
 IP20 / class II / **CE**  
 bílá  
 3000K/ 4000K/6000K  
 pro 2 fázový systém

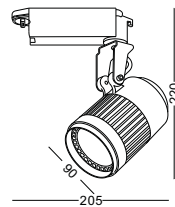

● **LSP204**

materiál: hliník  
 CREE COB 1512 18W / WW  
 Ra85 / 1800lm / 24°  
 obsahuje zdroj  
 IP20 / class II / **CE**  
 bílá  
 3000K/ 4000K/6000K  
 pro 2 fázový systém

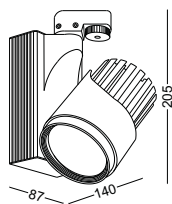

- **LSP201**
- materiál: hliník
- CREE COB 2520 24W / WW
- Ra85 / 2400lm / 24°
- obsahuje zdroj
- IP20 / class II/CE
- bílá
- 3000K/ 4000K/6000K
- pro 2 fázový systém

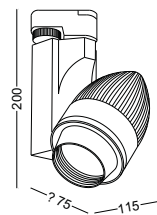

- **LSP203**
- materiál: hliník
- CREE COB 1512 18W / WW
- Ra85 / 2400lm / 24°
- obsahuje zdroj
- IP20 / class II/CE
- bílá
- 3000K/ 4000K/6000K
- pro 2 fázový systém





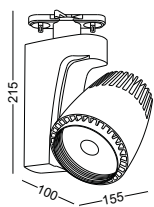

- **LSP206**  
 materiál: hliník  
 CREE COB 2520 30W / WW  
 Ra85 / 3000lm / 24°  
 obsahuje zdroj  
 IP20 / class II/ **CE**  
 bílá  
 3000K/ 4000K/6000K  
 pro 2 fázový systém

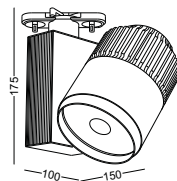

- **LSP205**  
 materiál: hliník  
 CREE COB 2520 30W / WW  
 Ra85 / 3000lm / 24°  
 obsahuje zdroj  
 IP20 / class II/ **CE**  
 bílá  
 3000K/ 4000K/6000K  
 pro 2 fázový systém



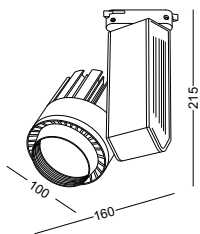

- **LSP208**  
materiál: hliník  
CREE COB 2520 30W / WW  
Ra85 / 3000lm / 24°  
obsahuje zdroj  
IP20 / class II/CE  
bílá  
3000K/ 4000K/6000K  
pro 2 fázový systém

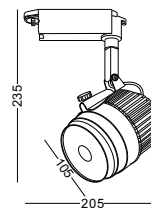

- **LSP207**  
materiál: hliník  
CREE COB 2520 30W / WW  
Ra85 / 3000lm / 24°  
obsahuje zdroj  
IP20 / class II/CE  
bílá  
3000K/ 4000K/6000K  
pro 2 fázový systém



- **TR-LPL155-WT**  
materiál: hliník  
CREE 6X1W / WW  
Ra85 / 732lm / 30°  
obsahuje zdroj  
IP20 / class II/ **CE**  
bílá  
3000K/ 4000K/6000K  
pro 2 fázový systém

- **TR-LPL155-BK**  
materiál: hliník  
CREE 6X1W / WW  
Ra85 / 732lm / 30°  
obsahuje zdroj  
IP20 / class II/ **CE**  
černá  
3000K/4000K/6000K  
pro 2 fázový systém



● *TR-LPL176*

materiál: hliník  
COB LED 5W / WW  
Ra80 / 500lm /  
obsahuje zdroj  
IP20 / class II/CE  
Akrylový difuzor  
3000K/ 4000K/6000K  
pro 2 fázový systém

● *TR-LPL174*

materiál: hliník  
COB LED 5W / WW  
Ra80 / 500lm /  
obsahuje zdroj  
IP20 / class II/CE  
Akrylový difuzor  
3000K/ 4000K/6000K  
pro 2 fázový systém

- **TR-HL012-BK**  
materiál: hliník  
CREE 1X3W / WW  
Ra85 / 122lm / 30°  
obsahuje zdroj  
IP20 / class II/ **CE**  
černá  
3000K/4000K/6000K  
pro 2 fázový systém

- **TR-HL012-WT**  
materiál: hliník  
CREE 1X3W / WW  
Ra85 / 122lm / 30°  
obsahuje zdroj  
IP20 / class II/ **CE**  
bílá  
3000K/ 4000K/6000K  
pro 2 fázový systém

- **TR-LPL045-BK**
- **TR-LPL045-WT**  
materiál: hliník  
CREE 1X3W / WW  
Ra85 / 122lm / 30°  
obsahuje zdroj  
IP20 / class II/ **CE**  
černá/bílá  
3000K/4000K/6000K  
pro 2 fázový systém



● **TR-LPL202**

materiál: hliník  
SMD LED 4.5W / WW  
Ra80 / 450lm  
obsahuje zdroj  
IP20 / class II/ **CE**  
černá/akrylový difuzor  
3000K/4000K/6000K  
pro 2 fázový systém

● **TR-LPL187**

materiál: hliník  
CREE 1X3W / WW  
Ra85 / 122lm  
obsahuje zdroj  
IP20 / class II/ **CE**  
černá/Akrylový difuzor  
3000K/4000K/6000K  
pro 2 fázový systém

# LED PANEL Y

*LED PANELY jsou oblíbené pro svou snadnou instalaci, malou spotřebu a nízké pořizovací náklady.*

*Díky stíhlému provedení se tato svítidla stala modním trendem a velmi rychle nahrazují zářivkové boxy v kancelářích a jiných prostorách.*

*Výkon 48 W dává dostatečných 3840 lm měkkého rovnoměrného světla.*

*Každé svítidlo je dodáváno s příslušenstvím pro tři možnosti uchycení - závěšení, zapuštění a vložení.*

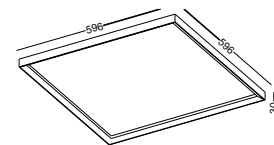

**LQL001-BK**

materiál: hliník  
LED SMD 3014 48W / WW  
Ra80 / 3840lm  
bez zdroje  
IP20 / class III / CE  
černá  
příslušenství pro  
tři možnosti instalace:  
zavěšení,  
zapuštění,  
přisazení





■ **LQL001-WT**

materiál: hliník  
LED SMD 3014 48W / WW  
Ra80 /3840lm  
bez zdroje  
IP20 / class III /  $\text{CE}$   
bílá  
příslušenství pro  
tři možnosti instalace:  
zavěšení,  
zapuštění,  
přisazení



■ **LQL001-SL**

materiál: hliník  
LED SMD 3014 48W / WW  
Ra80 /3840lm  
bez zdroje  
IP20 / class III /  $\text{CE}$   
painted stříbrná  
příslušenství pro  
tři možnosti instalace:  
zavěšení,  
zapuštění,  
přisazení

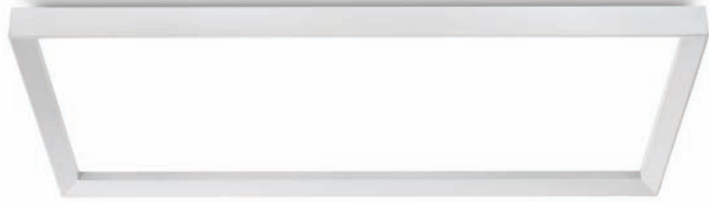

LED PANEL Y

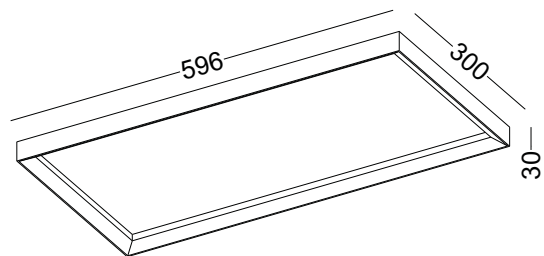

- **LQL002-BK**  
materiál: hliník  
LED SMD 3014 24W / WW  
Ra80 / 1920lm  
bez zdroje  
IP20 / class III / cĚ  
bílá  
příslušenství pro  
tři možnosti instalace:  
zavěšení,  
zapuštění,  
přisazení
- **LQL002-WT**  
bílá
- **LQL002-SL**  
stříbrná

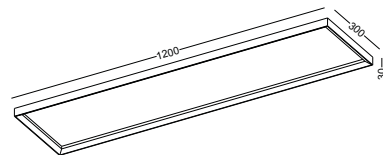

- **LQL004-BK**  
materiál: hliník  
LED SMD 3014 40W / WW  
Ra80 / 3200lm  
bez zdroje  
IP20 / class III / ce  
bílá  
příslušenství pro  
tři možnosti instalace:  
zavěšení,  
zapuštění,  
přisazení

- **LQL004-WT**  
bílá

- **LQL004-SL**  
stříbrná

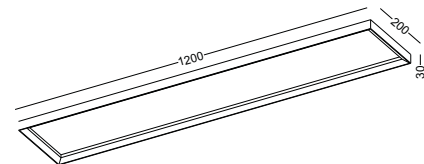

■ **LQL003-BK**  
materiál: hliník  
LED SMD 3014 40W / WW  
Ra80 / 3200lm  
bez zdroje  
IP20 / class III /  $\text{ce}$   
bílá  
příslušenství pro  
tři možnosti instalace:  
zavěšení,  
zapuštění,  
přisazení

■ **LQL003-WT**  
bílá

■ **LQL003-SL**  
stříbrná



SLIM FIT LED PANNEL LIGHT FOR OFFICE ROOFS 600x600MM

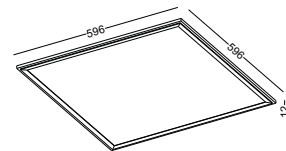

■ **LQL014-WT**

materiál: hliník  
LED SMD 3014 48W / WW  
Ra80 /3840lm  
bez zdroje  
IP20 / class III / cē  
bílá  
zápuštná instalace



SLIM FIT LED PANNEL LIGHT FOR OFFICE ROOFS 600x300MM



SLIM FIT LED PANNEL LIGHT FOR OFFICE ROOFS 1200x600MM



#### ■ LQL013-WT

materiál: hliník  
LED SMD 3014 24W / WW  
Ra80 /2400lm  
bez zdroje  
IP20 / class III / CE  
bílá  
zápustná instalace

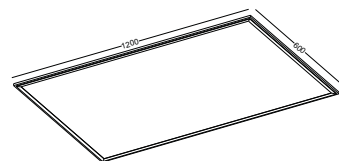

#### ■ LQL017-WT

materiál: hliník  
LED SMD 3014 64W / WW  
Ra80 /6400lm  
bez zdroje  
IP20 / class III / CE  
bílá  
zápustná instalace



VYSOCE VÝKONNÝ  
LED PANEL  
300x300MM 12W  
PRO KUCHYŇĚ A  
UMÝVÁRNÝ

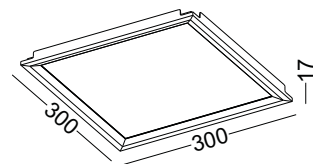

- **LQL011-SL**  
materiál: hliník  
LED SMD 3014 12W / WW  
Ra80 / 1200lm  
bez zdroje  
IP20 / class III Kč  
stříbrná  
nasazovací instalace
- **LQL011-WT**  
bílá





VYSOCE VÝKONNÝ  
LED PANEL  
600x300MM 24W  
PRO KUCHYŇĚ A  
UMÝVÁRNÝ

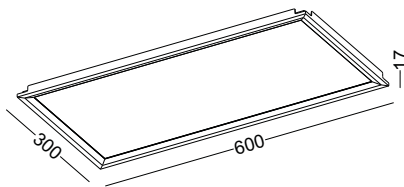

■ **LQL012-SL**

materiál: hliník  
LED SMD 3014 24W / WW  
Ra80 / 2400lm  
bez zdroje  
IP20 / class III Kč  
stříbrná  
Push-up installation

■ **LQL012-WT**

bílá





LED PANELY

# LED ZÁPUSTNÉ BODOVKY





- LDC880-SL
- LDC880-CR
- LDC880-BK
- LDC880-GD
- LDC880-WT
- LDC880-RD

materiál: hliník  
 LED 1W / WW  
 Ra90 / 366lm / 20  
 bez zdroje  
 IP20 / class III/   
 SL: stříbrná  
 CR: chrom  
 BK: černá  
 GD: zlatá  
 WT: bílá  
 RD: růžové zlato  
 průměr výřezu 2 cm  
 3000K/ 4000K/6000K

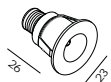







STAR LIGHT



## STAR LIGHT



1W DOT LIGHT  
FLAT

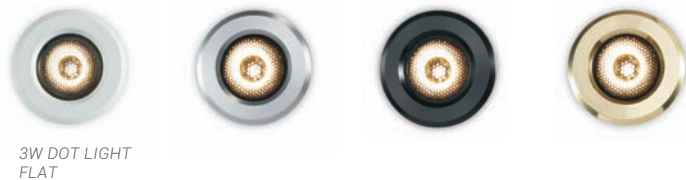



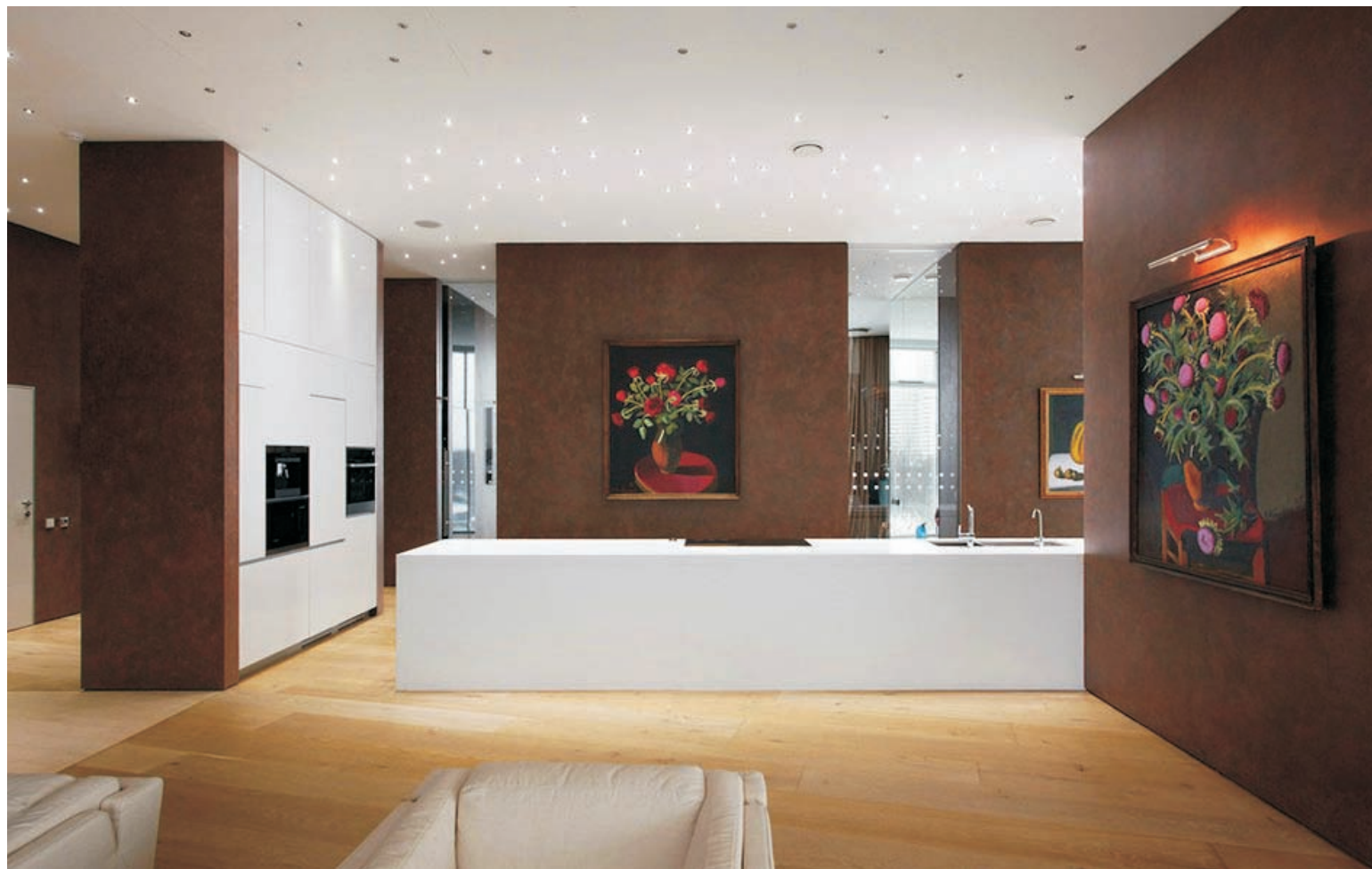



- **LDC880A-GD**  
materiál: hliník  
CREE LED 1W / WW  
Ra90 / 126lm  
bez zdroje  
IP20 / class III /  $\epsilon\epsilon$   
zlatá  
průměr výřezu 20mm

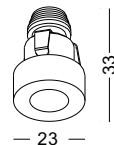

- **LDC880B-GD**  
materiál: hliník CREE  
LED 1W / WW Ra90 /  
126lm  
bez zdroje IP20 /  
class III /  $\epsilon\epsilon$   
zlatá  
průměr výřezu 20mm

- **LDC880A-SL**  
stříbrná

- **LDC880B-SL**  
Anodized stříbrná

- **LDC880A-WT**  
bílá

- **LDC880B-WT**  
bílá

- **LDC880A-BK**  
černá

- **LDC880B-BK**  
černá



- **LDC005A-GD**  
materiál: hliník  
CREE LED 3W / WW  
Ra90 / 210lm  
bez zdroje  
IP20 / class III /  $\epsilon\epsilon$   
zlatá  
průměr výřezu 30mm

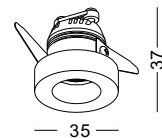

- **LDC006A-GD**  
materiál: hliník  
CREE LED 3W / WW  
Ra90 / 210lm  
bez zdroje  
IP20 / class III /  $\epsilon\epsilon$   
zlatá  
průměr výřezu 30mm

- **LDC005A-SL**  
stříbrná

- **LDC006A-SL**  
stříbrná

- **LDC005A-WT**  
bílá

- **LDC006A-WT**  
bílá

- **LDC005A-BK**  
černá

- **LDC006A-BK**  
černá

*Od dětství jsme snili o tom, že budeme spát pod nebem plným hvězd.*

*Tato série svítidel umožňuje tento sen splnit. Malá svítidla instalovaná blízko u sebe, září jako nebe plné hvězd.*

# INSTALLATION

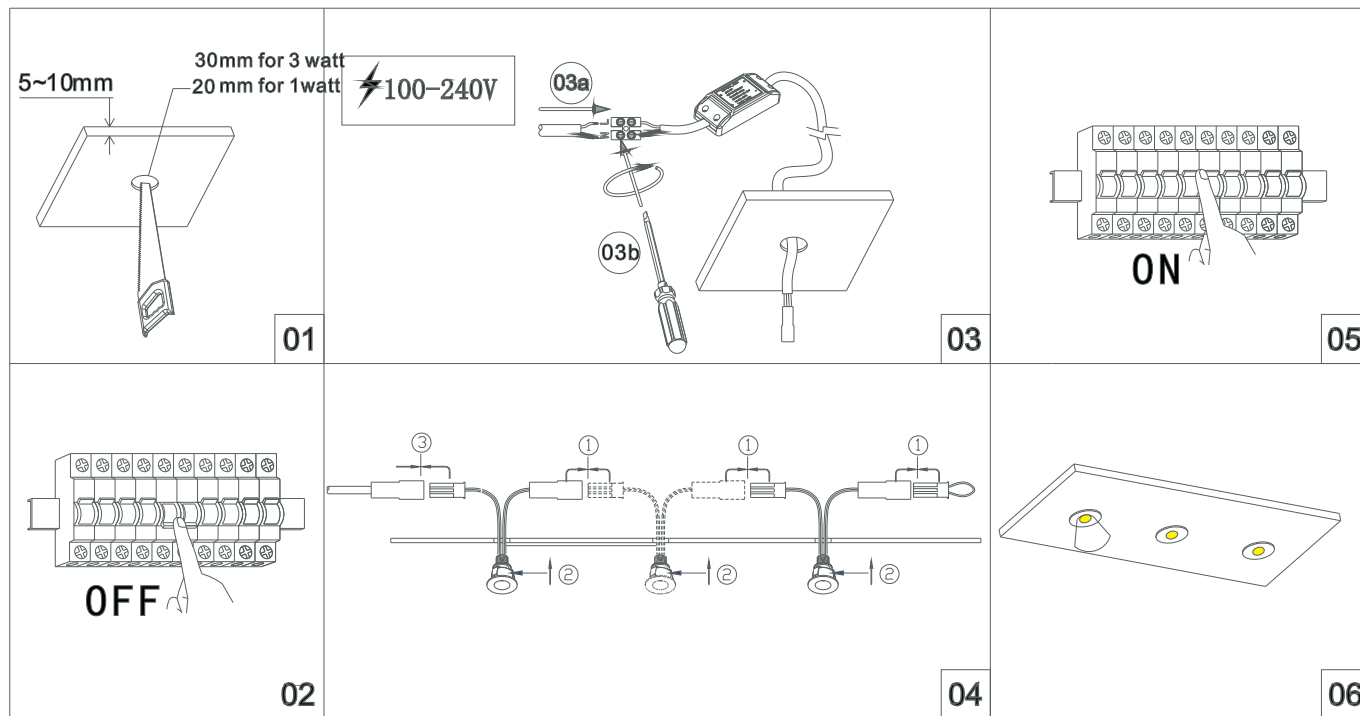

LED MINI SPOTS  
ROTATABLE



*Tato série je ideální pro instalace do míst jako jsou šatny,  
skříňě či vytríny.*

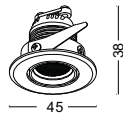

- **LDC001A-GD**  
materiál : hliník CREE  
LED 3W / WW  
Ra90 /210lm  
bez zdroje IP20 /  
class III / cē  
zlatá  
průměr výřezu 40mm
- **LDC001A-SL**  
stříbrná
- **LDC001A-WT**  
bílá
- **LDC001A-BK**  
černá



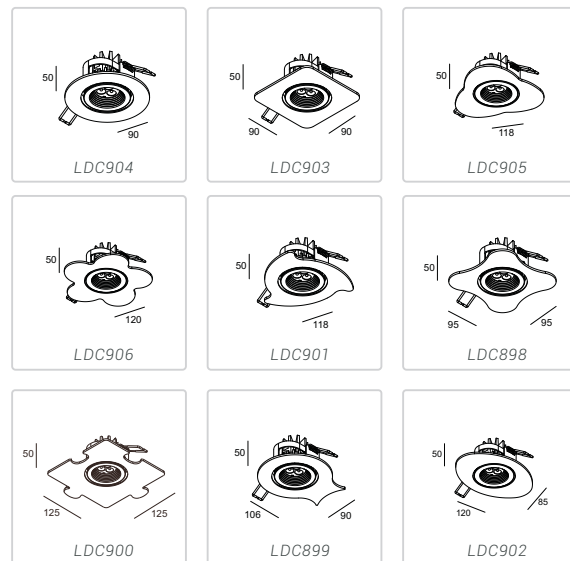
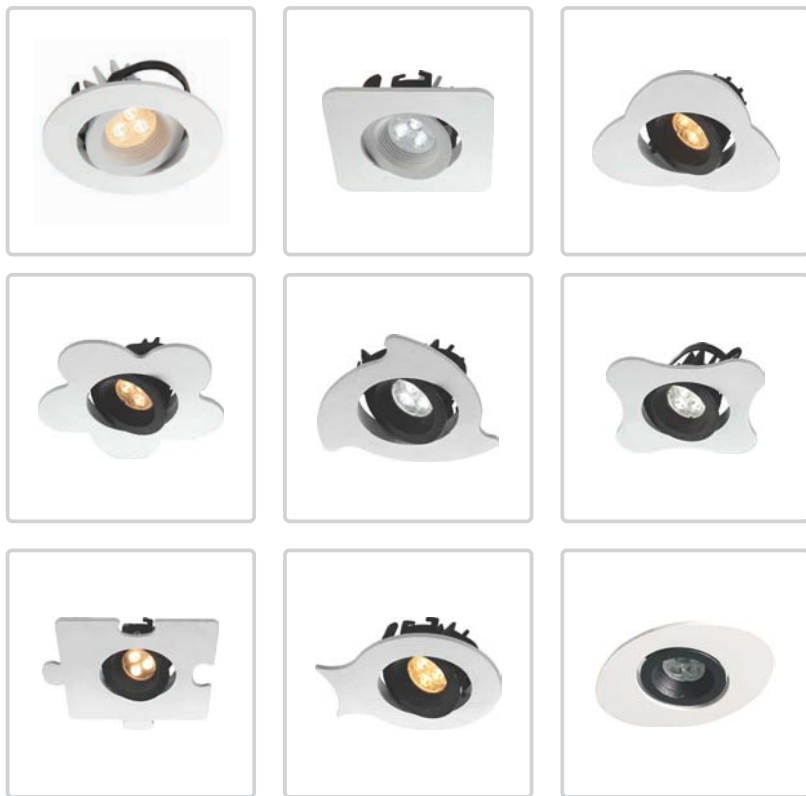



● LDC898-LDC906

materiál: hliník  
CREE LED 3W / WW  
Ra90 / 366lm / 30 °  
bez zdroje  
IP20 / class III **CE**  
bílá  
průměr výřezu 70mm  
3000k/ 4000k/6000k

- Hliníkové odlitky
- CREE LED
- stínítko tvarováno ražbou
- LDC900 mohou být seskupeny jako puzzle
- otočné ve všech úhlech
- výřez - průměr 70mm



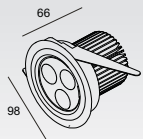

- **LDC801**  
materiál: hliník  
LED 9W / WW  
Ra90 / 510lm / 30°  
bez zdroje 9W  
IP20 / class III / **CE**  
stříbrná  
průměr výřezu 90mm

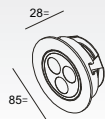

- **LDC301**  
materiál: hliník  
LED 3W / WW  
Ra85 / 300lm / 30°  
bez zdroje 3W  
IP20 / class III / **CE**  
stříbrná  
průměr výřezu 70mm

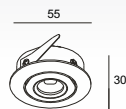

- **LDC001**  
materiál: hliník  
LED 3W / WW  
Ra85 / 170lm / 30°  
bez zdroje 3W  
IP20 / class III / **CE**  
stříbrná  
průměr výřezu 50mm

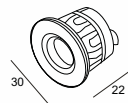

- **LDC028**  
materiál: hliník  
LED 1W / WW  
Ra85 / 100lm / 30°  
bez zdroje 1W  
IP20 / class III / **CE**  
stříbrná  
průměr výřezu 25mm

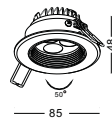

- **LDC935A** materiál: hliník  
LED 3W / WW  
Ra80 / 300lm  
bez zdroje  
IP20 / class III /  $\epsilon$   
bílá a černá  
průměr výřezu 70mm



- **LDC936A** materiál: hliník  
LED 5W / WW  
Ra80 / 500lm  
bez zdroje  
IP20 / class III /  $\epsilon$   
bílá a černá  
průměr výřezu 90mm

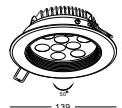

- **LDC938A** materiál: hliník  
LED 9W / WW  
Ra80 / 900lm  
bez zdroje  
IP20 / class III /  $\epsilon$   
bílá a černá  
průměr výřezu 115mm

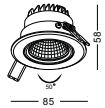

- **LDC926-WT**  
materiál: hliník  
COB LED 5W / WW  
Ra85 / 500lm  
bez zdroje  
IP20 / class III /  $\text{C}\epsilon$   
bílá  
průměr výřezu 70mm

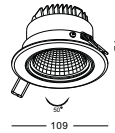

- **LDC927-WT**  
materiál: hliník  
COB LED 9W / WW  
Ra85 / 900lm  
bez zdroje  
IP20 / class III /  $\text{C}\epsilon$   
bílá  
průměr výřezu 96mm

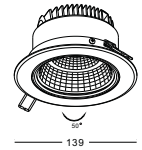

- **LDC928-WT**  
materiál: hliník  
COB LED 13W / WW  
Ra85 / 1300lm  
bez zdroje  
IP20 / class III /  $\text{C}\epsilon$   
bílá  
průměr výřezu  
115mm

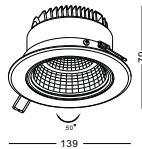

- **LDC928-SL**  
materiál: hliník  
COB LED 13W / WW  
Ra85 /1300lm  
bez zdroje  
IP20 / class III /  $\epsilon\epsilon$   
broušenástříbrná  
průměrvýřezu 115mm



- **LDC927-SL**  
materiál: hliník  
COB LED 9W / WW  
Ra85 /900lm  
bez zdroje  
IP20 / class III /  $\epsilon\epsilon$   
broušenástříbrná  
průměrvýřezu 96mm

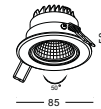

- **LDC926-SL**  
materiál: hliník  
COB LED 5W / WW  
Ra85 /500lm  
bez zdroje  
IP20 / class III /  $\epsilon\epsilon$   
broušenástříbrná  
průměrvýřezu 70mm

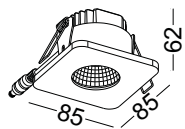

- **LDC979B**  
materiál: hliník  
COB LED 5W / WW  
Ra85 /500lm  
bez zdroje  
IP20 / class III / ⚡  
broušená stříbrná  
3000K/4000K/6000K  
průměr výřezu 70mm

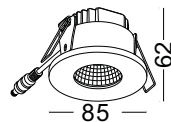

- **LDC978B**  
materiál: hliník  
COB LED 5W / WW  
Ra85 /500lm  
bez zdroje  
IP20 / class III / ⚡  
broušená stříbrná  
3000K/4000K/6000K  
průměr výřezu 70mm

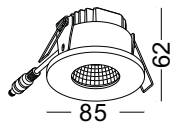

- **LDC978A**  
materiál: hliník  
acrylic cover  
COB LED 5W / WW  
Ra85 /500lm/38 stupňů  
bez zdroje  
IP20 / class III /  $\epsilon$   
3000K/ 4000K/6000K  
průměr výřezu 70mm

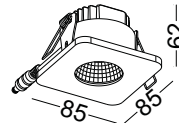

- **LDC979A**  
materiál: hliník  
acrylic cover  
COB LED 5W / WW  
Ra85 /500lm/38 stupňů  
bez zdroje  
IP20 / class III /  $\epsilon$   
3000K/ 4000K/6000K  
průměr výřezu 70mm

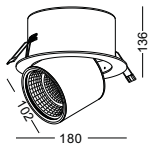

- **LDC970** materiál: hliník  
COB LED 13W / WW  
Ra85 / 1300lm/38 stupňů  
bez zdroje  
IP20 / class III / CE  
bílá  
průměr výřezu 150mm  
volně otočný a zatažitelný  
úhel svitu 30 až 90 stupňů

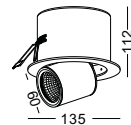

- **LDC969** materiál: hliník  
COB LED 5W / WW  
Ra85 / 500lm/38 stupňů  
bez zdroje  
IP20 / class III / CE  
bílá  
průměr výřezu 115mm  
volně otočný a zatažitelný  
úhel svitu 30 až 90 stupňů



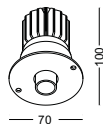

- **LDC985** materiál: hliník  
CREE XML 10W / WW  
Ra90 / 900lm/30 stupňů  
bez zdroje  
IP20 / class III / ě  
černá  
průměr výřezu 20mm  
vhodný pro obchody se šperky



- **LDC984** materiál: hliník  
CREE XML 10W / WW  
Ra90 / 900lm/30 stupňů  
bez zdroje  
IP20 / class III / ě  
černá  
průměr výřezu 55mm  
vhodný pro obchody se šperky





- **LDC988-BK**  
materiál: hliník  
CREE COB 1304 5W / WW  
Ra90 / 500lm/38 stupňů  
bez zdroje  
IP40 / class III /  $\text{C}\text{E}$   
černá  
průměr výřezu 72mm



- **LDC989-BK**  
materiál: hliník  
CREE COB 1507 9W / WW  
Ra90 / 900lm/38 stupňů  
bez zdroje  
IP40 / class III /  $\text{C}\text{E}$   
černá  
průměr výřezu 97mm



- **LDC990-BK**  
materiál: hliník  
CREE COB 1512 12W / WW  
Ra90 / 1200lm/38stupňů  
bez zdroje  
IP40 / class III /  $\text{C}\text{E}$   
černá  
průměr výřezu 122mm



- **LDC991-BK**  
materiál: hliník  
CREE COB 1512 20W / WW  
Ra90 / 2000lm/38stupňů  
bez zdroje  
IP40 / class III /  $\text{C}\text{E}$   
černá  
průměr výřezu 122mm

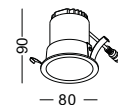

- **LDC988-WT**  
materiál: hliník CREE COB  
1304 5W / WW Ra90 /  
500lm/38stupňů bez  
zdroje  
IP40 / class III /  $\text{C}\text{E}$   
bílá  
průměr výřezu 72mm

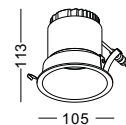

- **LDC989-WT**  
materiál: hliník CREE COB  
1507 9W / WW Ra90 /  
900lm/38stupňů bez  
zdroje  $\text{C}\text{E}$   
IP40 / class III /  
bílá  
průměr výřezu 97mm

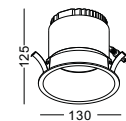

- **LDC990-WT**  
materiál: hliník  
CREE COB 1512 12W / WW  
Ra90 / 1200lm/38stupňů  
bez zdroje  $\text{C}\text{E}$   
IP40 / class III /  
bílá  
průměr výřezu 122mm

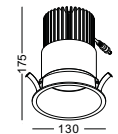

- **LDC991-WT**  
materiál: hliník  
CREE COB 1512 20W / WW  
Ra90 / 2000lm/38stupňů



- **LDC988-GD**  
materiál: hliník  
CREE COB 1304 5W / WW  
Ra90 / 500lm/38 stupňů  
bez zdroje  
IP40 / class III / cĚ  
zlatá  
průměr výřezu 72mm

- **LDC989-GD**  
materiál: hliník  
CREE COB 1507 9W / WW  
Ra90 / 900lm/38 stupňů  
bez zdroje  
IP40 / class III / cĚ  
zlatá  
průměr výřezu 97mm

- **LDC990-GD**  
materiál: hliník  
CREE COB 1512 12W / WW  
Ra90 / 1200lm/38 stupňů  
bez zdroje  
IP40 / class III / cĚ  
zlatá  
průměr výřezu 122mm

- **LDC991-GD**  
materiál: hliník  
CREE COB 1512 20W / WW  
Ra90 / 2000lm/38 stupňů  
bez zdroje  
IP40 / class III / cĚ  
zlatá  
průměr výřezu 122mm



*Tato série high bay zapuštěných bodových světel je speciálně navržena pro veřejné prostory, které potřebují vysoký jas, mnoho lumenů, ale také široký neoslňující úhel svitu jako jsou hotely či letiště.*

*Používáme CREE COB 1507,1512,1520 čipy s výkonem 12W, 20W,a 30W, které vzdají 1200 lm, 2000 lm a 3000lm, což je ve většině případů dostatečné.*

*Teplota čipu při testech nepřekročila 55 stupňů díky množství instalovaných chladičů.Snadno dosáhne životnosti 30 000 hodin, což je výborná zpráva vzhledem k údržbě.*

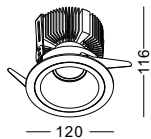

- **CSL001**  
materiál: hliník  
CREE COB 1507 12W / WW  
Ra90 /1200lm/24 stupňů  
bez zdroje  
IP20 / class III /cē  
bílá  
průměr výřezu 100mm  
vhodné pro hotely

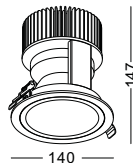

- **CSL002**  
materiál: hliník  
CREE COB 1512 18W / WW  
Ra90 /2000lm/24 stupňů  
bez zdroje  
IP20 / class III /cē  
bílá  
průměr výřezu 120mm  
vhodné pro hotely

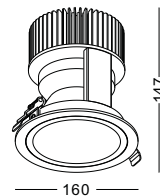

- **CSL003**  
materiál: hliník  
CREE COB 1520 30W / WW  
Ra90 /3000lm/24 stupňů  
bez zdroje  
IP20 / class III /cē  
bílá  
průměr výřezu 140mm  
vhodné pro hotely



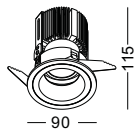

- **CSL005-CR**  
materiál: hliník  
CREE COB 1507 9W / WW  
Ra90 / 1200lm/24stupňů  
bez zdroje  
IP20 / class III / $\epsilon$   
bílá  
průměr výřezu 75mm  
vhodné pro hotely

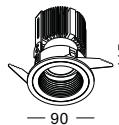

- **CSL005-BK**  
materiál: hliník CREE COB  
1507 9W / WW  
Ra90 / 1200lm/24 stupňů  
bez zdroje  
IP20 / class III / $\epsilon$   
bílá  
průměr výřezu 75mm  
vhodné pro hotely

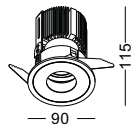

- **CSL005-RU**  
materiál: hliník  
CREE COB 1507 9W / WW  
Ra90 / 1200lm/24 stupňů  
bez zdroje  
IP20 / class III / $\epsilon$   
bílá  
průměr výřezu 75mm  
vhodné pro hotely

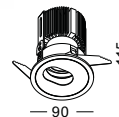

- **CSL005-RT**  
materiál: hliník  
CREE COB 1507 9W / WW  
Ra90 / 1200lm/24 stupňů  
bez zdroje  
IP20 / class III / $\epsilon$   
bílá  
průměr výřezu 75mm  
vhodné pro hotely



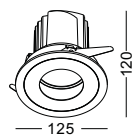

- **CSL009-RU**  
materiál: hliník  
CREE COB 1512 12W / WW  
Ra90 /1800lm/24stupňů  
bez zdroje  
IP20 / class III / $\epsilon$   
bílá  
průměr výřezu 110 mm  
vhodné pro hotely  
otočné o 30 stupňů

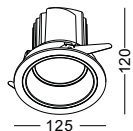

- **CSL009-BK**  
materiál: hliník  
CREE COB 1512 12W / WW  
Ra90 /1800lm/24stupňů  
bez zdroje  
IP20 / class III / $\epsilon$   
bílá  
průměr výřezu 110 mm  
vhodné pro hotely  
otočné o 30 stupňů

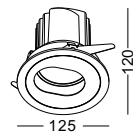

- **CSL009-RT**  
materiál: hliník  
CREE COB 1512 12W / WW  
Ra90 /1800lm/24 stupňů  
bez zdroje  
IP20 / class III /  
bílá  
průměr výřezu 110 mm  
vhodné pro hotely  
otočné o 30 stupňů

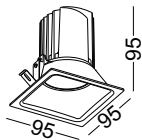

- **CSL007-SM**  
materiál: hliník  
CREE COB 1507 9W / WW  
Ra90 / 900lm/24 stupňů  
bez zdroje  
IP20 / class III / cĕ  
bílá  
výřez 80x80 mm

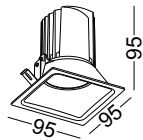

- **CSL008-SM**  
materiál: hliník  
CREE COB 1507 9W / WW  
Ra90 / 900lm/24 stupňů  
bez zdroje  
IP20 / class III / cĕ  
bílá  
výřez 80x80 mm  
otočný o 30 stupňů

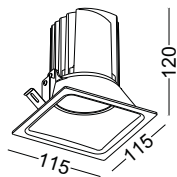

- **CSL007-BG**  
materiál: hliník  
CREE COB 1512 12W / WW  
Ra90 /900lm/24stupňů  
bez zdroje  
IP20 / class III /cē  
bílá  
výřez 100x100mm

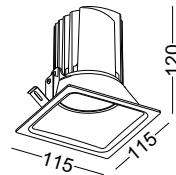

- **CSL008-BG**  
materiál: hliník  
CREE COB 1512 12W / WW  
Ra90 /900lm/24stupňů  
bez zdroje  
IP20 / class III /cē  
bílá  
výřez 100x100mm  
otočný o 30 stupňů

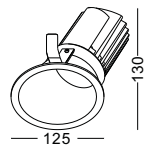

- **CSL006-BG**  
materiál: hliník  
CREE COB 1512 12W / WW  
Ra90 / 1200lm/24 stupňů  
bez zdroje  
IP20 / class III / cĕ  
bílá  
průměr výřezu 110mm  
úhel náklonu 45 stupňů

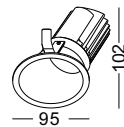

- **CSL006-SM**  
materiál: hliník CREE COB  
1507 9W / WW Ra90 /  
900lm/24stupňů  
bez zdroje  
IP20 / class III / cĕ  
bílá  
průměr výřezu 85mm  
úhel náklonu 45 stupňů

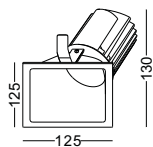

- **CSL011-BG**  
materiál: hliník  
CREE COB 1512 12W / WW  
Ra90 / 1200lm/24stupňů  
bez zdroje  
IP20 / class III /ce  
bílá  
výřez 110X110mm  
úhel náklonu 45 stupňů

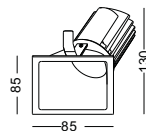

- **CSL011-SM**  
materiál: hliník  
CREE COB 1507 9W / WW  
Ra90 / 900lm/24 stupňů  
bez zdroje  
IP20 / class III /ce  
bílá  
výřez 85X85mm  
úhel náklonu 45 stupňů

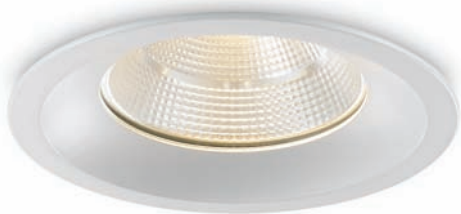

● **CDL001**

materiál: hliník  
CREE COB 1507 9W / WW Ra85  
/900lm/38 stupňů  
bez zdroje  
IP40 / class III / cč  
bílá  
průměr výřezu 100mm

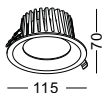

● **CDL002**

materiál: hliník  
CREE COB 1507 12W / WW  
Ra85 /1200lm/38 stupňů  
bez zdroje  
IP40 / class III / cč  
bílá  
průměr výřezu 120mm

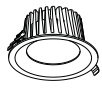

● **CDL003**

materiál: hliník  
CREE COB 1512 20W / WW  
Ra85 /1800lm/38 stupňů  
bez zdroje  
IP40 / class III / cč  
bílá  
průměr výřezu 150mm



● **CDL004**

materiál: hliník  
CREE COB 1520 30W / WW  
Ra85 /3000lm/38 stupňů  
bez zdroje  
IP40 / class III / cč  
bílá  
průměr výřezu 170mm

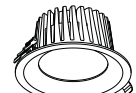



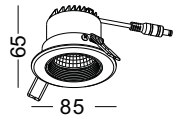

- **LDC926A-SL**  
materiál: hliník  
CREE COB 5W / WW  
Ra80 / 500lm/38 stupňů  
bez zdroje  
IP20 / class III / cě  
stříbrná a černá  
průměr výřezu 70mm  
3000K/4000K/6000K

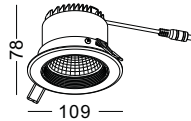

- **LDC927A-SL**  
materiál: hliník  
CREE COB 9W / WW  
Ra80 / 900lm/38 stupňů  
bez zdroje  
IP20 / class III / cě  
stříbrná a černá  
průměr výřezu 90mm  
3000K/4000K/6000K

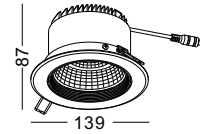

- **LDC928A-SL**  
materiál: hliník CREE COB  
12W / WW  
Ra80 / 1200lm/38 stupňů  
bez zdroje  
IP20 / class III / cě  
stříbrná a černá  
3000K/ 4000K/6000K  
průměr výřezu 115mm



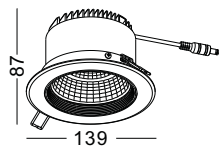

- **LDC928A-WT**  
materiál: hliník  
CREE COB 12W / WW  
Ra80 / 1200lm/38 stupňů  
bez zdroje  
IP20 / class III / cĕ  
bílá  
3000K/4000K/6000K  
průměr výřezu 115mm

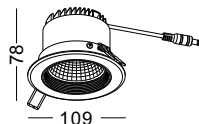

- **LDC927A-WT**  
materiál: hliník  
CREE COB 9W / WW  
Ra80 / 900lm/38 stupňů  
bez zdroje  
IP20 / class III / cĕ  
bílá  
3000K/4000K/6000K  
průměr výřezu 90mm

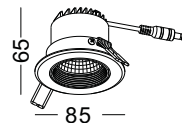

- **LDC926A-WT**  
materiál: hliník  
CREE COB 5W / WW  
Ra80 / 500lm/38 stupňů  
bez zdroje  
IP20 / class III / cĕ  
bílá  
3000K/4000K/6000K  
průměr výřezu 70mm



- **LDC992-BK**  
materiál: hliník  
CREE COB 6W / WW  
Ra85 / 600lm/38 stupňů  
bez zdroje  
IP20 / class III  $\xi$   
černá  
3000K/4000K/6000K  
průměr výřezu 50mm
- **LDC992-SL**  
stříbrná
- **LDC992-WT**  
bílá
- **LDC992-GD**  
zlatá



HLUBOCE ZAPUŠTĚNÉ  
MINI COB BODOVKY  
6W až 600lm CRI85  
otočné

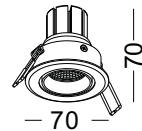

- LDC993-BK  
materiál: hliník  
CREE COB 6W / WW  
Ra85 / 600lm/38 stupňů  
bez zdroje  
IP20 / class III /cē  
černá  
3000K/4000K/6000K  
průměr výřezu 60mm
- LDC993-SL  
stříbrná
- LDC993-WT  
bílá
- LDC993-GD  
zlatá



- **LDC994-SL**  
materiál: hliník  
CREE COB 6W / WW  
Ra85 /600lm/38 stupňů  
bez zdroje  
IP20 / class III /  $\epsilon$   
broušená stříbrná  
3000K/4000K/6000K  
průměr výřezu 65mm



- **LDC995-SL**  
materiál: hliník  
CREE COB 2x6W / WW  
Ra85 /1200lm/38 stupňů  
bez zdroje  
IP20 / class III /  $\epsilon$   
broušená stříbrná  
3000K/4000K/6000K  
výřez 65X145mm



- **LDC996-SL**  
materiál: hliník  
CREE COB 3x6W / WW  
Ra85 /1800lm/38 stupňů  
bez zdroje  
IP20 / class III /  $\epsilon$   
broušená stříbrná  
3000K/4000K/6000K  
výřez 65X145mm

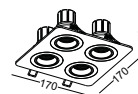

- **LDC997-SL**  
materiál: hliník  
CREE COB 4x6W / WW  
Ra85 /2400lm/38 stupňů  
bez zdroje  
IP20 / class III /  $\epsilon$   
broušená stříbrná  
3000K/4000K/6000K  
výřez 145X145mm



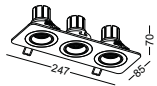

- **LDC996-SL**  
materiál: hliník  
CREE COB 3x6W / WW  
Ra85 /1800lm/38 stupňů  
bez zdroje  
IP20 / class III /ce  
broušená stříbrná  
3000K/4000K/6000K  
výřez 65X145mm

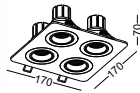

- **LDC997-SL**  
materiál: hliník  
CREE COB 4x6W / WW  
Ra85 /2400lm/38 stupňů  
bez zdroje  
IP20 / class III /ce  
broušená stříbrná  
3000K/4000K/6000K  
výřez 145X145mm



- **LDC994-SL**  
materiál: hliník  
CREE COB 6W / WW  
Ra85 /600lm/38 stupňů  
bez zdroje  
IP20 / class III /ce  
broušená stříbrná  
3000K/4000K/6000K  
průměr výřezu 65mm

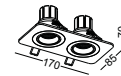

- **LDC995-SL**  
materiál: hliník  
CREE COB 2x6W / WW  
Ra85 /1200lm/38 stupňů  
bez zdroje  
IP20 / class III /ce  
broušená stříbrná  
3000K/4000K/6000K  
výřez 65X145mm





BEZOBROUČKOVÁ  
HLUBOCE ZAPUŠTĚNÁ  
BODOVÁ SVÍTIDLA  
AŽ 12W  
SNADNÁ NSTALLACE

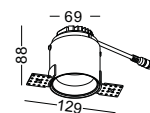

- **LDC339**  
materiál: hliník CREE  
COB 5W / WW  
Ra85 / 500lm/38 stupňů  
bez zdroje  
IP20 / class III /  
bílá  
3000K/4000K/6000K  
výřez 74mm

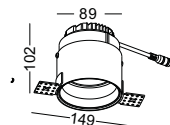

- **LDC340**  
materiál: hliník CREE  
COB 9W / WW Ra85 /  
900lm/38 stupňů bez  
zdroje  
IP20/ class III / ě  
bílá  
3000K/4000K/6000K  
výřez 94mm

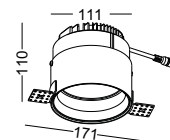

- **LDC341**  
materiál: hliník  
CREE COB 12W / WW  
Ra85 / 1200lm/38 stupňů  
bez zdroje  
IP20 / class III / ě  
bílá  
3000K/4000K/6000K  
výřez 116mm



BEZOBROUČKOVÁ  
HLUBOCE ZAPUŠTĚNÁ  
BODOVÁ SVÍTIDLA  
AŽ 12W  
SNADNÁ NŠTALACE  
OTOČNÁ

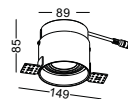

- LDC342  
materiál: hliník  
CREE COB 5W / WW  
Ra85 / 500lm/38 stupňů  
bez zdroje  
IP20 / class III /  
bílá  
3000K/4000K/6000K  
výřez 94mm

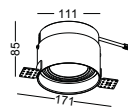

- LDC343  
materiál: hliník  
CREE COB 9W / WW  
Ra85 / 900lm/38 stupňů  
bez zdroje  
IP20 / class III /čč  
bílá  
3000K/4000K/6000K  
výřez 116mm

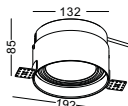

- LDC344  
materiál: hliník  
CREE COB 12W / WW  
Ra85 / 1200lm/38 stupňů  
bez zdroje  
IP20 / class III /čč  
bílá  
3000K/4000K/6000K  
výřez 137mm

# MODULÁRNÍ SYSTÉM





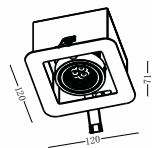

● LDC889

materiál: hliník  
CREE LED 9W / WW  
Ra90 / 510lm / 30°  
bez zdroje  
IP20 / class III / **CE**  
bílá  
výřez - 105x105mm  
3000K/4000K/6000K

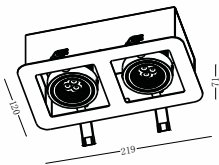

● LDC890

materiál: hliník  
CREE LED 18W / WW  
Ra90 / 1020lm / 30°  
bez zdroje 18W  
IP20 / class III / **CE**  
bílá  
výřez - 204x105mm  
3000K/4000K/6000K

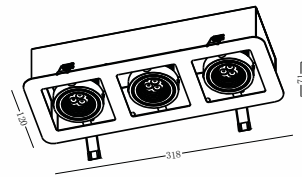

● LDC891

materiál: hliník  
CREE LED 27W / WW  
Ra90 / 1530lm / 30°  
bez zdroje 27W  
IP20 / class III / **CE**  
bílá  
výřez - 303x105mm  
3000K/4000K/6000K



- **LDC892**  
materiál: hliník  
LED 36W / WW  
Ra90 / 2040lm / 30°  
bez zdroje 27W+9W  
IP20 / class III/CE  
bílá  
výřez - 402x105mm  
3000K/ 4000K/6000K



- **LDC893**  
materiál: hliník  
LED 36W / WW  
Ra90 / 2040lm / 30°  
bez zdroje 27W+9W  
IP20 / class III/CE  
bílá  
výřez - 204X204mm  
3000K/ 4000K/6000K

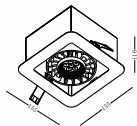

● **LDC923**

materiál: hliník  
 CREE LED 18W / WW  
 Ra90 / 1020lm / 30°  
 bez zdroje 18W  
 IP20 / class III/CE  
 bílá  
 výřez - 135x135mm  
 3000K/4000K/6000K

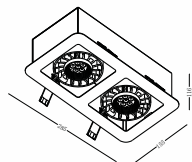

● **LDC924**

materiál: hliník  
 CREE LED 36W / WW  
 Ra90 / 2040lm / 30°  
 bez zdroje 2X18W  
 IP20 / class III/CE  
 bílá  
 výřez - 265x135mm 3000K/  
 4000K/6000K

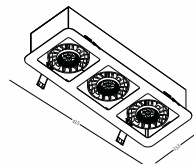

● **LDC925**

materiál: hliník  
 CREE LED 54W / WW  
 Ra90 / 3060lm / 30°  
 bez zdroje 3X18W  
 IP20 / class III/CE  
 bílá  
 výřez - 395x135mm 3000K/  
 4000K/6000K



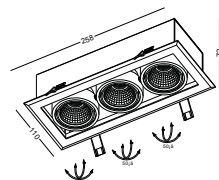

■ **LDC957**  
materiál: hliník  
LED 15W / WW  
Ra85 / 1500lm  
bez zdroje  
IP20 / class III /CE  
bílá výřez  
240X90mm

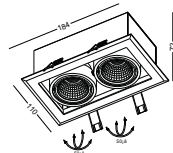

■ **LDC956**  
materiál: hliník  
LED 10W / WW  
Ra85 / 1000lm  
bez zdroje  
IP20 / class III /CE  
bílá výřez  
165X90mm

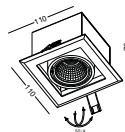

■ **LDC955**  
materiál: hliník  
COB 5W / WW  
Ra85 / 500lm  
bez zdroje  
IP20 / class III /CE  
bílá  
výřez 90X90mm



### LDC958

materiál: hliník  
COB 9W / WW  
Ra85 / 900lm  
bez zdroje  
IP20 / class III / cĚ  
bílá  
výřez 110X110mm

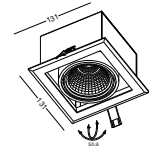

### LDC959

materiál: hliník  
COB 18W / WW  
Ra85 / 1800lm  
bez zdroje  
IP20 / class III / cĚ  
bílá  
výřez 205X110mm



### LDC960

materiál: hliník  
COB 27W / WW  
Ra85 / 2700lm  
bez zdroje  
IP20 / class III / cĚ  
bílá  
výřez 300X110mm

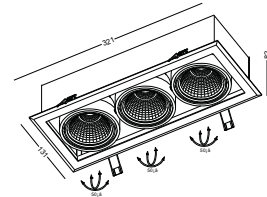







### LDC961

materiál: hliník  
COB 13W / WW  
Ra85 / 1300lm  
bez zdroje  
IP20 / class III / cĚ  
bílá  
výřez 135X135mm

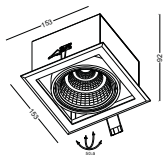

### LDC963

materiál: hliník  
COB 39W / WW  
Ra85 / 3900lm  
bez zdroje  
IP20 / class III / cĚ  
bílá  
výřez 365X135mm



### LDC962

materiál: hliník COB  
26W / WW Ra85 /  
2600lm  
bez zdroje  
IP20 / class III / cĚ  
bílá  
výřez 250X135mm  
3000K/4000K/6000K



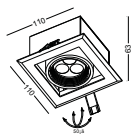

- **LDC940**  
materiál: hliník  
LED 3W / WW  
Ra85 / 300lm  
bez zdroje  
IP20/ class III /  $\text{C}\text{E}$   
bílá  
výřez 90X90mm

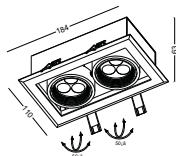

- **LDC941**  
materiál: hliník  
LED 6W / WW  
Ra85 / 600lm  
bez zdroje  
IP20/ class III /  $\text{C}\text{E}$   
bílá  
výřez 165X90mm

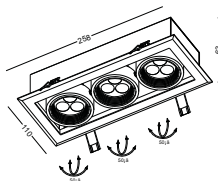

- **LDC942**  
materiál: hliník  
LED 9W / WW  
Ra85 / 900lm  
bez zdroje  
IP20/ class III /  $\text{C}\text{E}$   
bílá  
výřez 240X90mm





#### ■ LDC954

materiál: hliník  
LED 36W / WW  
Ra85 / 3600lm  
bez zdroje  
IP20 / class III / ě  
bílá  
výřez 365X135mm

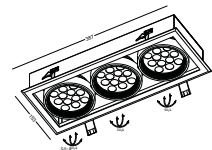

#### ■ LDC953

materiál: hliník  
LED 24W / WW  
Ra85 / 2400lm  
bez zdroje  
IP20 / class III / ě  
bílá  
výřez 250X135mm



#### ■ LDC952

materiál: hliník  
LED 12W / WW  
Ra85 / 1200lm  
bez zdroje  
IP20 / class III / ě  
bílá  
výřez 135X135mm

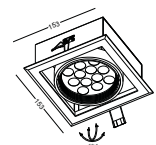



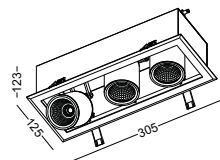

- **LDC319**  
materiál: hliník  
CREE COB 3X5W / WW  
Ra80 / 1500lm/38 stupňů  
bez zdroje  
IP20/ class III / ě  
bílá  
výřez 285X105mm  
3000k/4000k/6000k

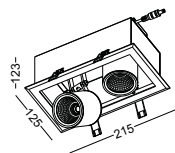

- **LDC318**  
materiál: hliník  
CREE COB 2X5W / WW  
Ra80 / 1000lm/38 stupňů  
bez zdroje  
IP20/ class III / ě  
bílá  
výřez 195X105mm  
3000k/4000k/6000k

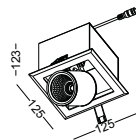

- **LDC317**  
materiál: hliník  
CREE COB 5W / WW  
Ra80 / 500lm/38 stupňů  
bez zdroje  
IP20 / class III ě  
bílá  
výřez 105X105mm  
3000k/4000k/6000k

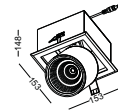

### ■ LDC320

materiál: hliník  
CREE COB 12W / WW  
Ra80 / 1200lm/38 stupňů  
bez zdroje  
IP20/ class III /  $\epsilon$   
bílá  
výřez 135X135mm  
3000k/4000k/6000k

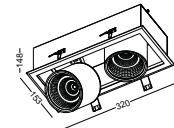

### ■ LDC321

materiál: hliník  
CREE COB 2X12W / WW  
Ra80 / 2400lm/38 stupňů  
bez zdroje  
IP20/ class III /  $\epsilon$   
bílá  
výřez 300X135mm  
3000k/4000k/6000k

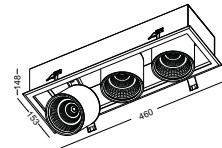

### ■ LDC322

materiál: hliník  
CREE COB 3x12W / WW  
Ra80 / 3600lm/38 stupňů  
bez zdroje  
IP20/ class III /  $\epsilon$   
bílá  
výřez 440X135mm  
3000k/4000k/6000k

# STROPNÍ SVÍTLIDLA





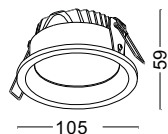

3 inch

#### ■ LDC931A-SL

materiál: hliník  
LED 6W / WW  
Ra85 / 600lm  
bez zdroje  
IP20/ class III / cē  
stříbrná  
průměr výřezu 90mm

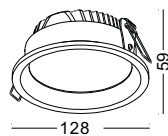

4 inch

#### ■ LDC932A-SL

materiál: hliník  
LED 9W / WW  
Ra85 / 900lm  
bez zdroje  
IP20/ class III / cē  
stříbrná  
průměr výřezu 115mm

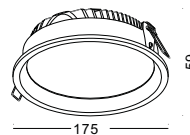

6 inch

#### ■ LDC934A-SL

materiál: hliník  
LED 20W / WW  
Ra85 / 2000lm  
bez zdroje  
IP20/ class III / cē  
stříbrná  
průměr výřezu 160mm

This series LED downlight has got 3 different sizes  
a 3 different colors, so totally 9 items.  
3 inches is průměr 105mm by 59mm height, with průměr  
výřezu 90mm  
4 inches is průměr 128mm by 59mm height, with průměr  
výřezu 115mm  
6 inches is průměr 175mm by 59mm height, with průměr  
výřezu 160mm

Those items are good at Kitchen, toilet ceiling a for  
bedside lighting, also passage is a good place to put  
this series, for the elegant out-looking a anti-glare  
shade.

The second vantage from this series is the lamp  
color, hliník stříbrná a gold is giving  
a metallic looking, clear, modern but not vulgar like  
shinning chrom.

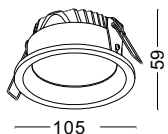

3 inch

- **LDC931A-GD**  
materiál: hliník  
LED 6W / WW  
Ra85 / 600lm  
bez zdroje  
IP20/ class III / cĚ  
zlatá  
průměr výřezu 90mm



4 inch

- **LDC932A-GD**  
materiál: hliník  
LED 9W / WW  
Ra85 / 900lm  
bez zdroje  
IP20/ class III / cĚ  
zlatá  
průměr výřezu 115mm

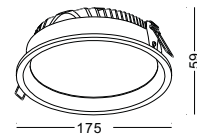

6 inch

- **LDC934A-GD**  
materiál: hliník  
LED 20W / WW  
Ra85 / 2000lm  
bez zdroje  
IP20/ class III / cĚ  
zlatá  
průměr výřezu 160mm

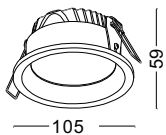

105

3 inch

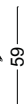

63

- **LDC931A-WT**
- materiál: hliník
- LED 6W / WW
- Ra85 / 600lm
- bez zdroje
- IP20/ class III / cE
- bílá
- průměr výřezu 90mm

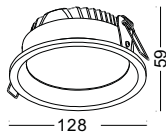

128

4 inch



63

- **LDC932A-WT**
- materiál: hliník
- LED 9W / WW
- Ra85 / 900lm
- bez zdroje
- IP20/ class III / cE
- bílá
- průměr výřezu 115mm

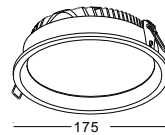

175

6 inch

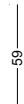

63

- **LDC934A-WT**
- materiál: hliník
- LED 20W / WW
- Ra85 / 2000lm
- bez zdroje
- IP20/ class III / cE
- bílá
- průměr výřezu 160mm





- **LDC964-WT**  
materiál: hliník  
SMD 6W / WW  
Ra85 / 600lm  
bez zdroje  
IP20 / class III / ě  
bílá  
průměr výřezu 60mm



- **LDC965-WT**  
materiál: hliník  
SMD 9W / WW  
Ra85 / 900lm  
bez zdroje  
IP20 / class III / ě  
bílá  
průměr výřezu 90mm



- **LDC966-WT**  
materiál: hliník  
SMD 16W / WW  
Ra85 / 1600lm  
bez zdroje  
IP20 / class III / ě  
bílá  
průměr výřezu 125mm



- **LDC967-WT**  
materiál: hliník  
SMD 20W / WW  
Ra85 / 2000lm  
bez zdroje  
IP20 / class III / ě  
bílá  
průměr výřezu 140mm

- **LDC964-SL**  
broušená stříbrná

- **LDC965-SL**  
broušená stříbrná

- **LDC966-SL**  
broušená stříbrná

- **LDC967-SL**  
broušená stříbrná

*Tuto sérii nazýváme M0000N, protože prvotní ideu tohoto svítidla inspiroval měsíc v úplňku, který je zcela kulatý, bez nejmenší odchyšky. Tato světla září jako skutečný měsíc. S velmi tenkým rámečkem vypadají na stropě jako krásné světelné koule.*

*Ve čtyřech velikostech dodají dostatek světla chodbám balkonům, toaletám či kuchyním.*



*Economic Version  
For series LDC858*



*LDC863C  
5 Inch 20W*



*LDC861C  
4 Inch 9W*



*LDC860C  
3.5 Inch 6W*



*LDC862C  
4.5 Inch 16W*



*LDC858C  
2 Inch 3W*



*LDC859C  
3 Inch 4.5W*





- **LDC858C**  
materiál: hliník  
SMD LED 3W / WW  
Ra80 / 300lm  
bez zdroje  
IP20/ class III / CE  
bílá  
průměr výřezu 75mm

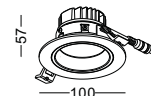

- **LDC859C**  
materiál: hliník  
SMD LED 4.5W / WW  
Ra80 / 450lm  
bez zdroje  
IP20/ class III / CE  
bílá  
průměr výřezu 90mm

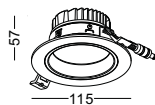

- **LDC860C**  
materiál: hliník  
SMD LED 6W / WW  
Ra80 / 600lm  
bez zdroje  
IP20/ class III / CE  
bílá  
průměr výřezu 100mm

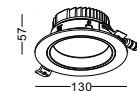

- **LDC861C**  
materiál: hliník  
SMD LED 9W / WW  
Ra80 / 900lm  
bez zdroje  
IP20/ class III / CE  
bílá  
průměr výřezu 115mm

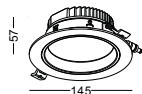

- **LDC862C**  
materiál: hliník  
SMD LED 16W / WW  
Ra80 / 1600lm  
bez zdroje  
IP20/ class III / CE  
bílá  
průměr výřezu 130mm

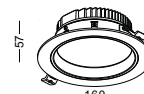

- **LDC863C**  
materiál: hliník  
SMD LED 20W / WW  
Ra80 / 2000lm  
bez zdroje  
IP20/ class III / CE  
bílá  
průměr výřezu 145mm

STROPNÍ ZAPUŠTĚNÝ  
LED PANEL  
UTRA TENKÝ A JASNÝ

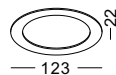

- **LDC201S-BK**  
materiál: hliník  
SMD LED 6W / WW  
Ra80 / 600lm  
bez zdroje  
IP20/ class III / cE  
černá  
průměr výřezu 105mm

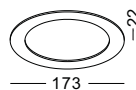

- **LDC201-BK**  
materiál: hliník  
SMD LED 12W / WW  
Ra80 / 1200lm  
bez zdroje  
IP20/ class III / cE  
černá  
průměr výřezu 160mm

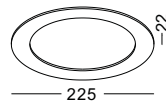

- **LDC202-BK**  
materiál: hliník  
SMD LED 18W / WW  
Ra80 / 1800lm  
bez zdroje  
IP20/ class III / cE  
černá  
průměr výřezu 205mm

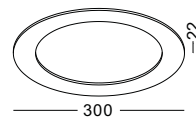

- **LDC203-BK**  
materiál: hliník  
SMD LED 24W / WW  
Ra80 / 2400lm  
bez zdroje  
IP20/ class III / cE  
černá  
průměr výřezu 280mm

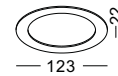

- **LDC201S-WT**  
materiál: hliník SMD  
LED 6W / WW Ra80 /  
600lm  
bez zdroje  
IP20/ class III /  $\text{CE}$   
bílá  
průměr výřezu 105mm

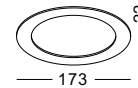

- **LDC201-WT**  
materiál: hliník  
SMD LED 12W / WW  
Ra80 / 1200lm  
bez zdroje  
IP20/ class III /  $\text{CE}$   
bílá  
průměr výřezu 160mm

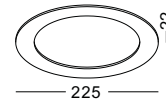

- **LDC202-WT**  
materiál: hliník  
SMD LED 18W / WW  
Ra80 / 1800lm  
bez zdroje  
IP20/ class III /  $\text{CE}$   
bílá  
průměr výřezu 205mm

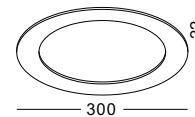

- **LDC203-WT**  
materiál: hliník  
SMD LED 24W / WW  
Ra80 / 2400lm  
bez zdroje  
IP20/ class III /  $\text{CE}$   
bílá  
průměr výřezu 280mm

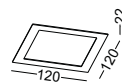

#### LDC204S-BK

materiál: hliník  
SMD LED 6W / WW  
Ra80 / 600lm  
bez zdroje  
IP20 / class III /  $\text{CE}$   
černá  
výřez 105x105mm



#### LDC204-BK

materiál: hliník  
SMD LED 12W / WW  
Ra80 / 1200lm  
bez zdroje  
IP20/ class III /  $\text{CE}$   
černá  
výřez 155x155mm

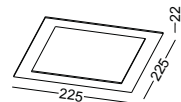

#### LDC205-BK

materiál: hliník  
SMD LED 18W / WW  
Ra80 / 1800lm  
bez zdroje  
IP20/ class III /  $\text{CE}$   
černá  
průměr výřezu 205x205mm

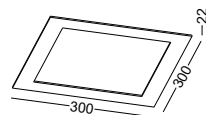

#### LDC206-BK

materiál: hliník  
SMD LED 24W / WW  
Ra80 / 2400lm  
bez zdroje  
IP20/ class III /  $\text{CE}$   
černá výřez  
280x280mm

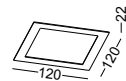
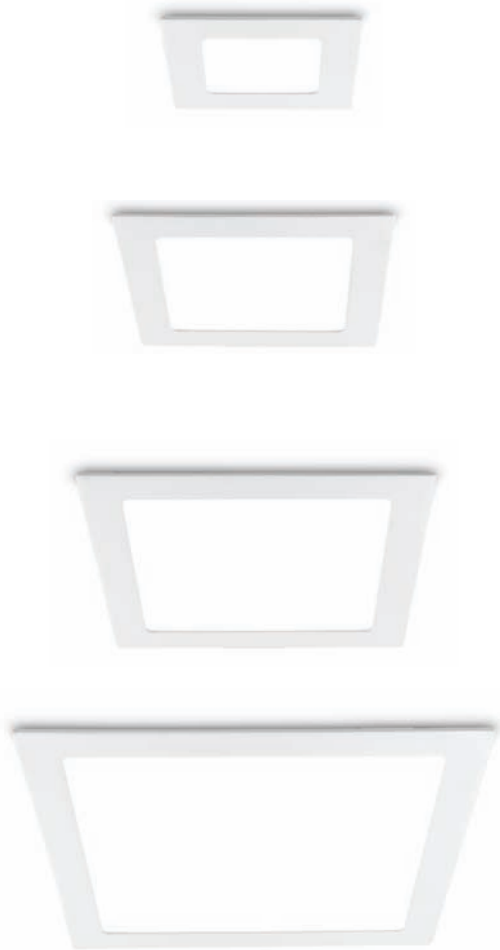

#### ■ LDC204S-WT

materiál: hliník  
SMD LED 6W / WW  
Ra80 / 600lm  
bez zdroje  
IP20/ class III / ☼  
bilá  
výřez 105x105mm

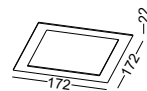

#### ■ LDC204-WT

materiál: hliník  
SMD LED 12W / WW  
Ra80 / 1200lm  
bez zdroje  
IP20/ class III / ☼  
bilá  
výřez 155x155mm

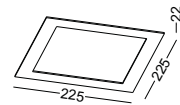

#### ■ LDC205-WT

materiál: hliník SMD LED  
18W / WW Ra80 /  
1800lm  
bez zdroje  
IP20/ class III / ☼  
bilá  
výřez 205x205mm

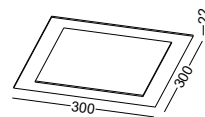

#### ■ LDC206-WT

materiál: hliník SMD  
LED 24W / WW Ra80  
/ 2400lm  
bez zdroje  
IP20/ class III / ☼  
bilá  
výřez 280x280mm

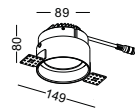
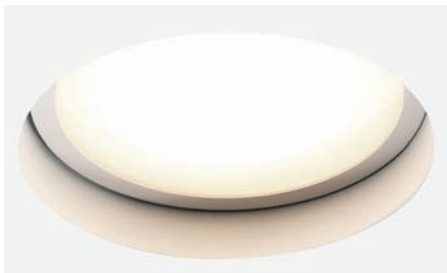
STROPNÍ BEZOBROUČKOVÉ  
ZAPUŠTĚNÉ SVÍTLIDLO

- **LDC345**  
materiál: hliník  
SMD LED 6W / WW  
Ra80 / 600lm  
bez zdroje  
IP20/ class III /  $\text{CE}$   
bílá  
průměr výřezu 94mm

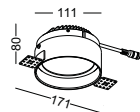

- **LDC346**  
materiál: hliník  
SMD LED 10W / WW  
Ra80 / 1000lm  
bez zdroje  
IP20/ class III /  $\text{CE}$   
bílá  
průměr výřezu 116mm

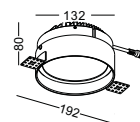

- **LDC347**  
materiál: hliník  
SMD LED 16W / WW  
Ra80 / 1600lm  
bez zdroje  
IP20/ class III /  $\text{CE}$   
bílá  
průměr výřezu 137mm



# LAMPY



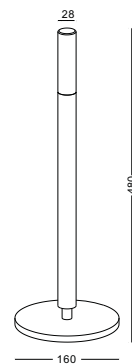

■ **LTL014-BK**

materiál: hliník  
CREE LED 1x3W / WW  
Ra85 / 170lm  
bez zdroje  
IP20/ class III / ⚡  
černá  
3000K/ 4000K/6000K  
akrylový difuzor

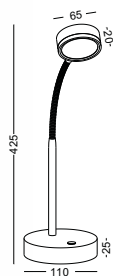

**LTL016-BK**  
 materiál: hliník  
 SMD LED 4W / WW  
 Ra80 / 400lm  
 obsahuje zdroj  
 IP20 / class II / CE  
 černá  
 3000K/4000K/6000K  
 Vypínač na základně

**LTL016-WT**  
 bílá



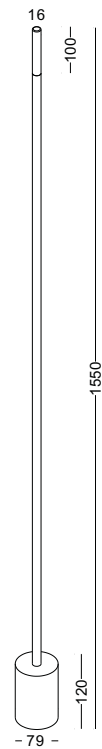

CREE LED 1W  
VOLNĚ STOJÍCÍ LAMPA  
VHODNÁ PRO DEKORACI  
OBÝVACÍHO POKOJE NEBO  
BALKONU.

■ **LFL019-WT**  
materiál: hliník  
CREE LED 1x1W / WW  
Ra85 /122lm  
obsahuje zdroj  
IP20 / class II /  $\text{C}\epsilon$   
bílá  
3000K/ 4000K/6000K  
Zelená/Modrá/Červená

■ **LFL019-BK**  
materiál: hliník  
CREE LED 1x1W / WW  
Ra85 /122lm  
obsahuje zdroj  
IP20 / class II /  $\text{C}\epsilon$   
černá  
3000K/ 4000K/ 6000K  
Zelená/Modrá/Červená



# LED OSVĚTLENÍ VYTRÍN



### LSD016

materiál: hliník  
CREE LED 1W / WW  
Ra90 /122lm/30 stupňů  
bez zdroje  
IP20/ class III /cē  
černá  
3000K/ 4000K/ 6000K  
průměr instalačního otvoru 2cm  
otočný o 120 stupňů

### LSD017

materiál: hliník  
CREE LED 2x1W / WW  
Ra90 /122lm/30 stupňů  
bez zdroje  
IP20/ class III /cē  
černá  
3000K/ 4000K/ 6000K  
průměr instalačního otvoru 2cm  
otočné o 120 stupňů

### LSD018

materiál: hliník  
CREE LED 3x1W / WW  
Ra90 /122lm/30 stupňů  
bez zdroje  
IP20/ class III /cē  
černá  
3000K/ 4000K/ 6000K  
průměr instalačního otvoru 2cm  
otočné o 120 stupňů

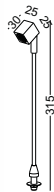

- **LSD014-CR**
- materiál: hliník
- CREE LED 1W / WW
- Ra90 / 122lm/30 stupňů
- bez zdroje
- IP20/ class III /  $\text{CE}$
- Chrom
- 3000K/ 4000K/6000K
- průměr instalačního otvoru 2cm

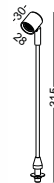

- **LSD013-CR**
- materiál: hliník
- CREE LED 1W / WW
- Ra90 / 122lm/30 stupňů
- bez zdroje
- IP20/ class III /  $\text{CE}$
- Chrom
- 3000K/ 4000K/6000K
- průměr instalačního otvoru 2cm



### ■ LSD013-BK

materiál: hliník  
CREE LED 1W / WW  
Ra90 /122lm/30 stupňů  
bez zdroje  
IP20/ class III /CE  
černá  
3000K/ 4000K/ 6000K  
průměr instalačního otvoru 2cm

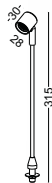

### ■ LSD014-BK

materiál: hliník  
CREE LED 1W / WW  
Ra90 /122lm/30 stupňů  
bez zdroje  
IP20/ class III /CE  
černá  
3000K/ 4000K/ 6000K  
průměr instalačního otvoru 2cm



LED

EXTERIÉROVÉ

OSVĚTLENÍ



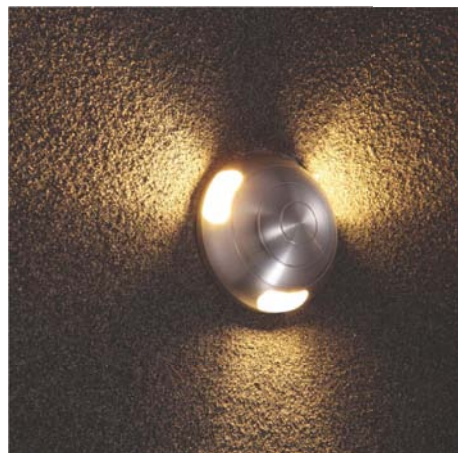

- **ODL007**  
materiál: hliník  
CREE LED 3W / WW  
Ra90 / 170lm  
bez zdroje  
IP44 / class III / **CE**  
stříbrná  
průměr výřezu 46mm



- **ODL008**  
materiál: hliník  
CREE LED 3W / WW  
Ra90 / 170lm  
bez zdroje  
IP44 / class III / **CE**  
stříbrná  
průměr výřezu 46mm



- **ODL009**  
materiál: hliník  
CREE LED 3W / WW  
Ra90 / 170lm  
bez zdroje  
IP44 / class III / **CE**  
stříbrná  
průměr výřezu 46mm

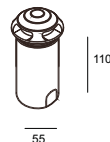

- **ODL010**  
materiál: hliník  
CREE LED 3W / WW  
Ra90 / 170lm  
bez zdroje  
IP44 / class III / **CE**  
stříbrná  
průměr výřezu 46mm



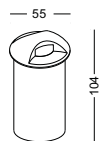

- **ODL025**  
materiál: hliník  
CREE LED 3W / WW  
Ra85 / 170lm  
bez zdroje  
IP67 / class III / **CE**  
stříbrná  
průměr výřezu 50X100mm  
3000k/4000k/6000k

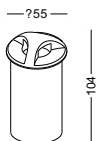

- **ODL026**  
materiál: hliník  
CREE LED 3W / WW  
Ra85 / 170lm  
bez zdroje  
IP67 / class III / **CE**  
stříbrná  
průměr výřezu 50X100mm  
3000k/4000k/6000k

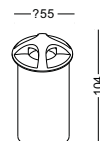

- **ODL027**  
materiál: hliník  
CREE LED 3W / WW  
Ra85 / 170lm  
bez zdroje  
IP67 / class III / **CE**  
stříbrná  
průměr výřezu 50X100mm  
3000k/ 4000k/6000k

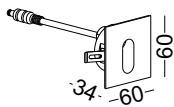
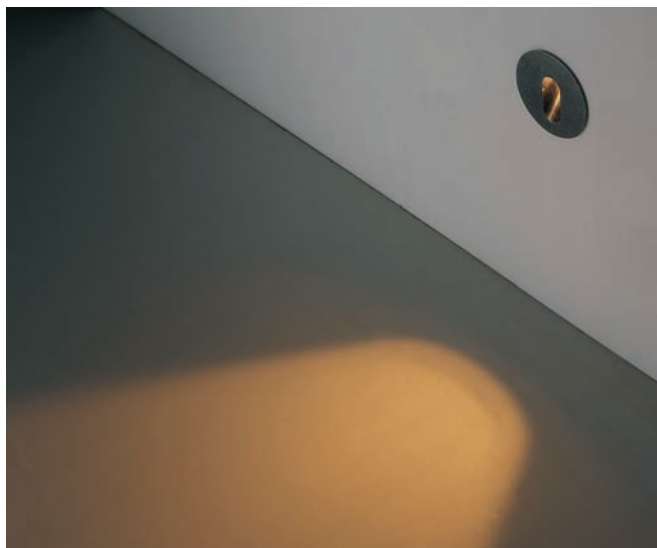
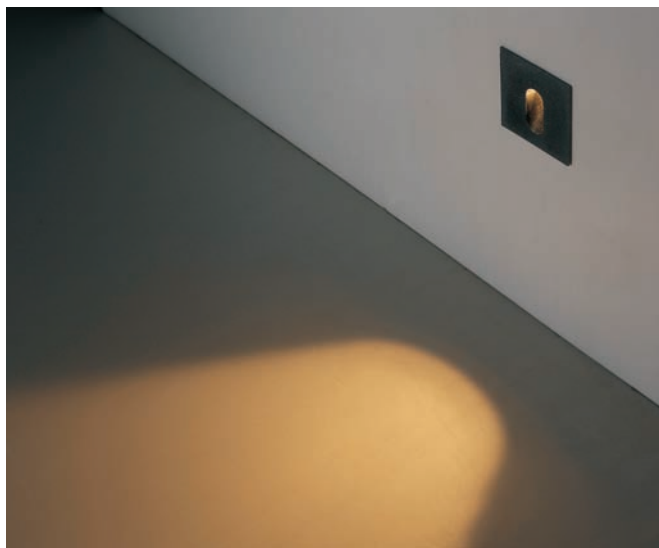

- **ODL041**
- materiál: hliník
- CREE LED 1W / WW
- Ra85 / 122lm
- bez zdroje
- IP65 / class III / CE
- černá
- průměr výřezu 55X110mm
- 3000k/ 4000k/6000k
- dodáváno s instalační krabičkou

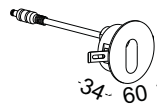

- **ODL042**
- materiál: hliník
- CREE LED 1W / WW
- Ra85 / 122lm
- bez zdroje
- IP65 / class III / CE
- černá
- průměr výřezu 55X110mm
- 3000k/ 4000k/6000k
- dodáváno s instalační krabičkou

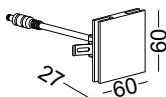

- ODL043  
materiál: hliník  
CREE LED 1W / WW  
Ra85 / 122lm  
bez zdroje  
IP65 / class III / CE  
černá  
průměr výřezu 55X110mm  
3000k/4000k/6000k  
dodáváno s instalační  
krabičkou



- ODL044  
materiál: hliník  
CREE LED 1W / WW  
Ra85 / 122lm  
bez zdroje  
IP65 / class III / CE  
černá  
průměr výřezu 55X110mm  
3000k/ 4000k/6000k  
dodáváno s instalační  
krabičkou



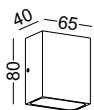

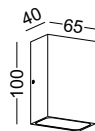

- LWA250
- materiál: hliník
- CREE LED 1W / WW
- Ra85 / 122lm
- obsahuje zdroj
- IP65/ class I /  $\text{CE}$
- černá
- povrchová montáž
- 3000k/4000k/6000k



- LWA251
- materiál: hliník
- CREE LED 2W / WW
- Ra85 / 244lm
- obsahuje zdroj
- IP65/ class I /  $\text{CE}$
- černá
- povrchová montáž
- 3000k/4000k/6000k

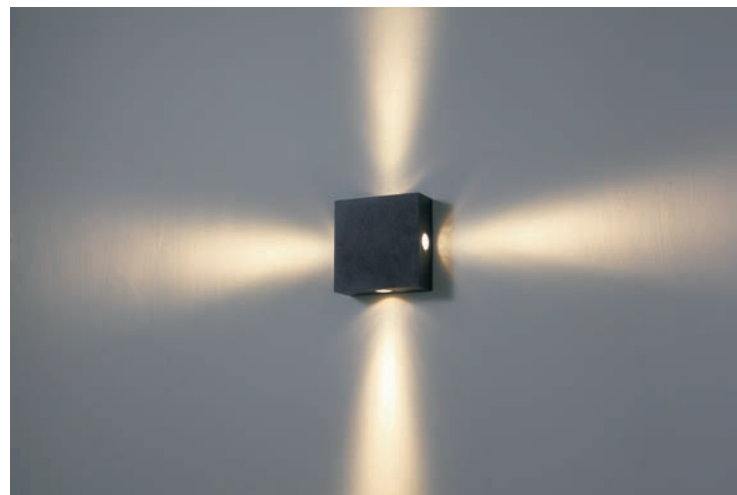



- **LWA247**  
materiál: hliník  
CREE LED 3W / WW  
Ra85 / 170lm  
obsahuje zdroj  
IP65/ class I /   
černá  
povrchová montáž  
3000k/4000k/6000k



- **LWA248**  
materiál: hliník  
CREE LED 2x3W / WW  
Ra85 / 340lm  
obsahuje zdroj  
IP65/ class I /   
černá  
povrchová montáž  
3000k/4000k/6000k



- **LWA249**  
materiál: hliník  
CREE LED 4x3W / WW  
Ra85 / 680lm  
obsahuje zdroj  
IP65/ class I /   
černá  
povrchová montáž  
3000k/4000k/6000k

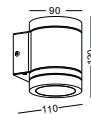

● LWA173A

materiál: hliník  
 COB LED 5W / WW  
 Ra85 / 500lm/38°  
 obsahuje zdroj  
 IP44 / class I / **CE**  
 černá  
 3000k/4000k/6000k

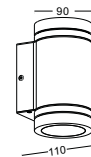

● LWA174A

materiál: hliník  
 COB LED 10W / WW  
 Ra85 / 1000lm/38°  
 obsahuje zdroj  
 IP44 / class I / **CE**  
 černá  
 3000k/4000k/6000k





● LWA215

materiál: hliník  
 COB LED 5W / WW  
 Ra85 / 500lm/38°  
 obsahuje zdroj  
 IP44 / class I / **CE**  
 černá  
 3000k/ 4000k/ 6000k

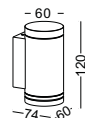

● LWA216

materiál: hliník  
 COB LED 2X5W / WW  
 Ra85 / 1000lm/38°  
 obsahuje zdroj  
 IP44 / class I / **CE**  
 černá  
 3000k/4000k/ 6000k

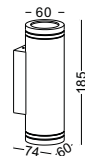

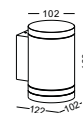

- LWA217  
materiál: hliník  
COB LED 9W / WW  
Ra85 / 900lm/38°  
obsahuje zdroj  
IP44 / class I / **CE**  
černá  
3000k/4000k/6000k

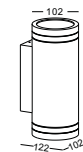

- LWA218  
materiál: hliník  
COB LED 2X9W / WW  
Ra85 / 1800lm/38°  
obsahuje zdroj  
IP44 / class I / **CE**  
černá  
3000k/4000k/6000k

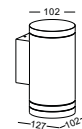
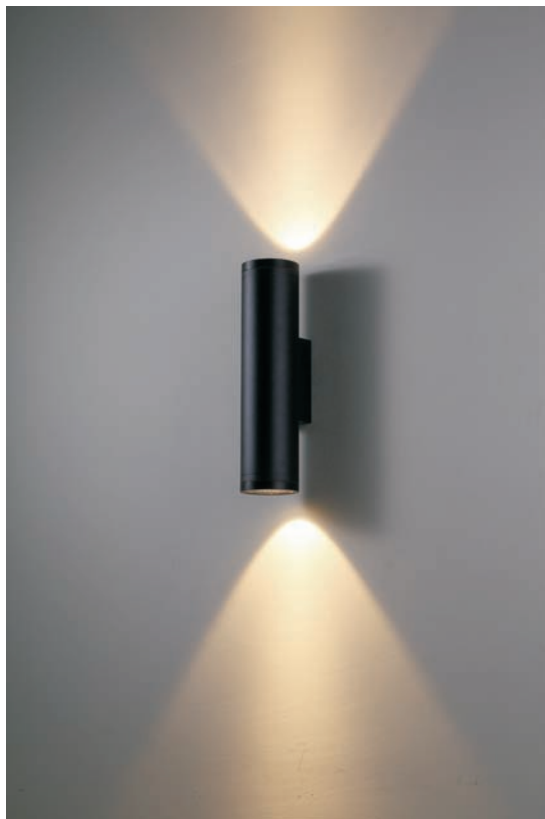

- LWA245  
materiál: hliník  
COB LED 20W / WW  
Ra85 / 2000lm/38°  
obsahuje zdroj  
IP44 / class I / **CE**  
černá  
3000k/4000k/6000k



- LWA246  
materiál: hliník  
COB LED 2x20W / WW  
Ra85 / 4000lm/38°  
obsahuje zdroj  
IP44 / class I / **CE**  
černá  
3000k/ 4000k/ 6000k

● LWA257

materiál: hliník  
COB LED 20W / WW  
Ra85 / 2000lm/38°  
obsahuje zdroj  
IP44 / class I / CE  
černá  
3000k/4000k/6000k

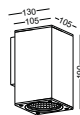

● LWA258

materiál: hliník  
COB LED 2x20W / WW  
Ra85 / 4000lm/38°  
obsahuje zdroj  
IP44 / class I / CE  
černá  
3000k/ 4000k/ 6000k

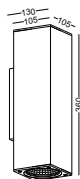

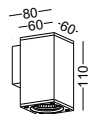

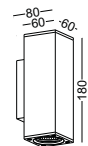

● LWA253

materiál: hliník  
COB LED 5W / WW  
Ra85 / 500lm/38°  
obsahuje zdroj  
IP44 / class I /    
černá  
3000k/4000k/6000k



● LWA254

materiál: hliník  
COB LED 2x5W / WW  
Ra85 / 1000lm/38°  
obsahuje zdroj  
IP44 / class I /    
černá  
3000k/ 4000k/6000k





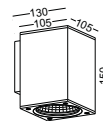

● LWA255

materiál: hliník  
COB LED 12W / WW  
Ra85 / 1200lm/38°  
obsahuje zdroj  
IP44 / class I / **CE**  
černá  
3000k/4000k/6000k

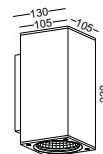

● LWA256

materiál: hliník  
COB LED 2x12W / WW  
Ra85 / 2400lm/38°  
obsahuje zdroj  
IP44 / class I / **CE**  
černá  
3000k/4000k/6000k

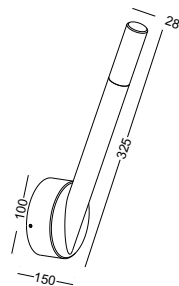

- LWA135
- materiál: hliník
- CREE LED 3W / WW
- Ra85 / 170lm
- obsahuje zdroj
- IP44 / class I /  $\text{CE}$
- černá
- akrylové stínitko
- 3000k/4000k/6000k

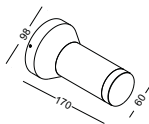

- LWA139
- materiál: hliník
- SMD LED 4. 5W / WW
- Ra80 / 450lm
- obsahuje zdroj
- IP44 / class II / **CE**
- černá
- akrylové stínitko
- 3000k/ 4000k/6000k

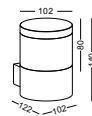

● LWA214

materiál: hliník  
pevný akrylový difuzor  
COB LED 9W / WW  
Ra85 / 900lm  
obsahuje zdroj  
IP44 / class I / **CE**  
černá  
3000k/4000k/6000k

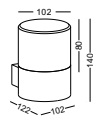

● LWA213

materiál: hliník  
pevný akrylový difuzor  
COB LED 9W / WW  
Ra85 / 900lm  
obsahuje zdroj  
IP44 / class I / **CE**  
černá  
3000k/4000k/6000k

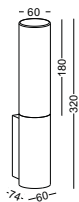

- LWA210  
materiál: hliník  
pevný akrylový difuzor  
COB LED 5W / WW  
Ra85 / 500lm  
obsahuje zdroj  
IP44 / class I / **CE**  
černá  
3000k/4000k/6000k

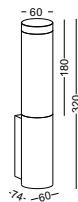

- LWA211  
materiál: hliník  
pevný akrylový difuzor  
COB LED 5W / WW  
Ra85 / 500lm  
obsahuje zdroj  
IP44 / class I / **CE**  
černá  
3000k/4000k/6000k



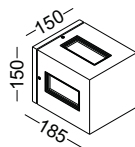
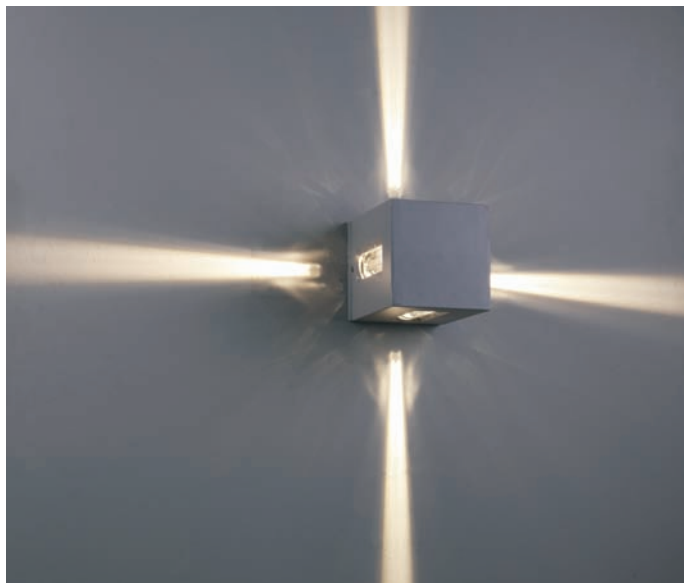

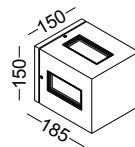

- LWA401
- materiál: hliník
- křišťálová čočka
- LED 4x3W / WW
- Ra85 / 680lm/8 stupňů
- obsahuje zdroj
- IP44 / class I / **CE**
- šedá
- 3000k/ 4000k/6000k

- LWA402
- materiál: hliník
- křišťál - plochý
- LED 4x3W / WW
- Ra85 / 680lm/60 stupňů
- obsahuje zdroj
- IP44 / class I / **CE**
- šedá
- 3000k/ 4000k/6000k

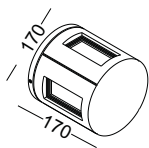
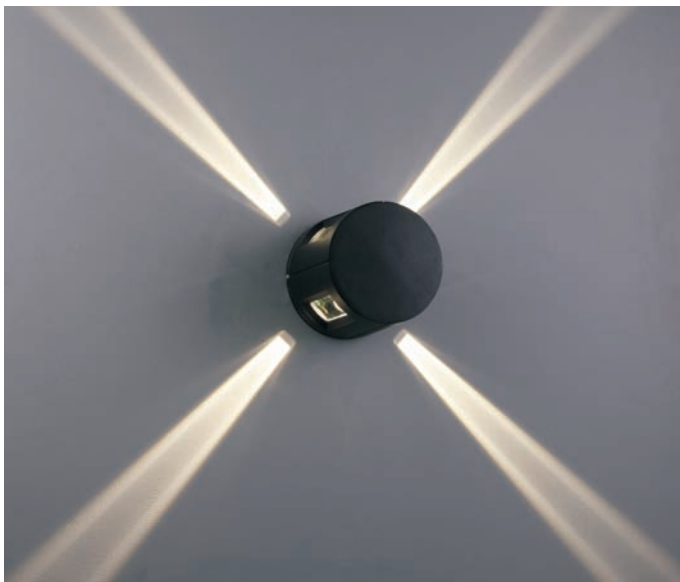



- LWA403
- materiál: hliník  
krištál - plochý  
LED 4x3W / WW  
Ra85 / 680lm/8 stupňů  
obsahuje zdroj  
IP44 / class I /   
šedá  
3000k/ 4000k/6000k

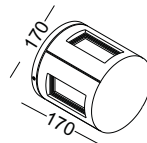

- LWA404
- materiál: hliník  
krištálová čočka  
LED 4x3W / WW  
Ra85 / 680lm/60 stupňů  
obsahuje zdroj  
IP44 / class I /   
šedá  
3000k/ 4000k/6000k

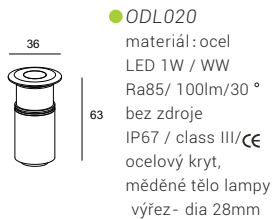

● **ODL020**  
 materiál: ocel  
 LED 1W / WW  
 Ra85/ 100lm/30°  
 bez zdroje  
 IP67 / class III/CE  
 ocelový kryt,  
 měděné tělo lampy  
 výřez- dia 28mm



● **ODL024**  
 materiál: ocel  
 LED 3W / WW  
 Ra90/ 170lm/30°  
 bez zdroje  
 IP67 / class III/CE  
 ocelový kryt,  
 měděné tělo lampy  
 výřez- dia 35mm

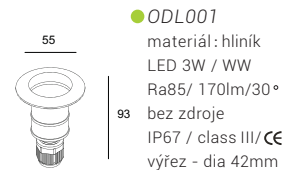

● **ODL001**  
 materiál: hliník  
 LED 3W / WW  
 Ra85/ 170lm/30°  
 bez zdroje  
 IP67 / class III/CE  
 výřez - dia 42mm







● **ODL031**

materiál:  
 ocelový kryt a  
 hliníkové tělo lampy  
 CREE LED 3X1W / WW  
 Ra90/ 366lm/30°  
 bez zdroje  
 IP67 / class III/ **CE**  
 výřez - dia 75XH90mm



● **ODL032**

materiál:  
 ocelový kryt a  
 hliníkové tělo lampy  
 CREE LED 6X1W / WW  
 Ra90/ 732lm/30°  
 bez zdroje  
 IP67 / class III/ **CE**  
 výřez - dia 90XH105mm



● **ODL033**

materiál:  
 ocelový kryt a  
 hliníkové tělo lampy  
 CREE LED 9X1W / WW  
 Ra90/ 1098lm/30°  
 bez zdroje  
 IP67 / class III/ **CE**  
 výřez - dia 105XH100mm

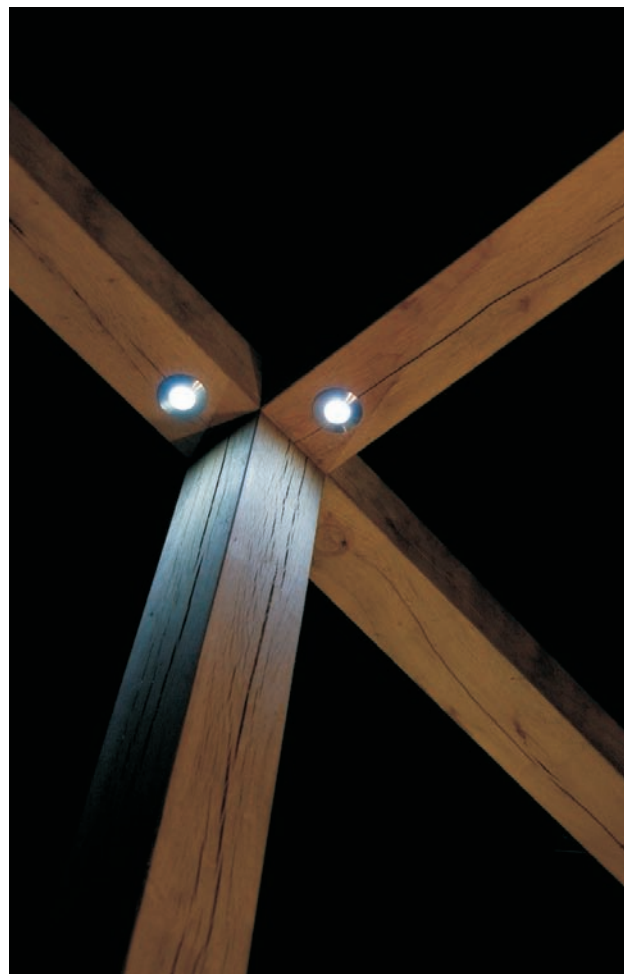

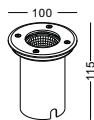

- **ODL028**  
materiál: hliník  
ocelový kryt  
COB LED 5W / WW  
Ra85 / 500lm/38°  
bez zdroje  
IP67 / class III / **CE**  
průměr výřezu 70X120mm  
3000k/4000k/6000k

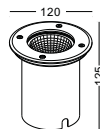

- **ODL029**  
materiál: hliník  
ocelový kryt  
COB LED 9W / WW  
Ra85 / 900lm/38°  
bez zdroje  
IP67 / class III / **CE**  
průměr výřezu 90X130mm  
3000k/4000k/6000k

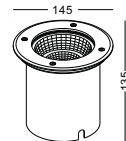

- **ODL030**  
materiál: hliník  
ocelový kryt  
COB LED 13W / WW  
Ra85 / 1300lm/38°  
bez zdroje  
IP67 / class III / **CE**  
průměr výřezu 110X140mm  
3000k/4000k/6000k

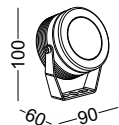

- **LSP155**  
 materiál: hliník  
 COB LED 5W / WW  
 Ra85 / 500lm/38°  
 bez zdroje  
 IP67 / class III / CE  
 černá  
 3000k/4000k/6000k

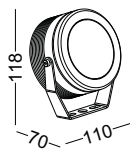

- **LSP156**  
 materiál: hliník  
 COB LED 9W / WW  
 Ra85 / 900lm/38°  
 bez zdroje  
 IP67 / class III / CE  
 černá  
 3000k/4000k/6000k

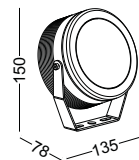

- **LSP157**  
 materiál: hliník  
 COB LED 13W / WW  
 Ra85 / 1300lm/38°  
 bez zdroje  
 IP67 / class III / CE  
 černá  
 3000k/4000k/6000k

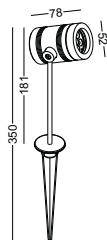

● **ODL035**

materiál: hliník  
CREE LED 6W / WW  
Ra85 / 732lm/30°  
bez zdroje  
IP66 / class III /  $\text{CE}$   
černá  
3000k/4000k/6000k

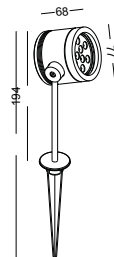

● **ODL036**

materiál: hliník  
CREE LED 9W / WW  
Ra85 / 1098lm/30°  
bez zdroje  
IP66 / class III /  $\text{CE}$   
černá  
3000k/4000k/6000k



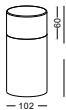

- **LFL009**  
materiál: hliník  
COB LED 9W / WW  
Ra85 / 900lm  
obsahuje zdroj  
IP44 / class I / **CE**  
černá  
3000k/4000k/6000k



- **LFL010**  
materiál: hliník  
COB LED 9W / WW  
Ra85 / 900lm  
obsahuje zdroj  
IP44 / class I / **CE**  
černá  
3000k/4000k/6000k



- **LFL011**  
materiál: hliník  
COB LED 9W / WW  
Ra85 / 900lm  
obsahuje zdroj  
IP44 / class I / **CE**  
černá  
3000k/4000k/6000k

LED ZAHRADNÍ SVÍTIDLA  
PEVNÝ AKRYLOVÝ DIFUZOR  
VYROBENO Z HLINÍKU

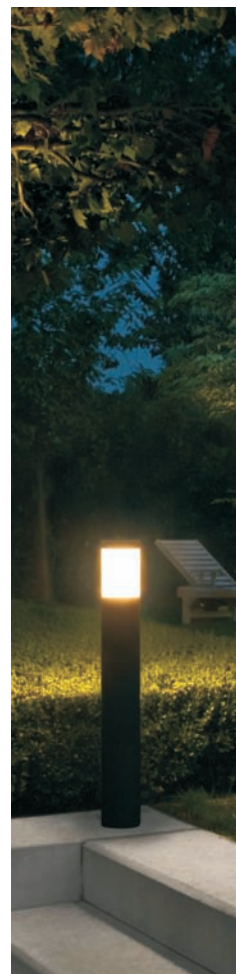



● **LFL006**

materiál: hliník COB  
LED 5W / WW  
Ra85 / 500lm  
obsahuje zdroj  
IP44 / class I / **CE**  
černá  
3000k/ 4000k/ 6000k

● **LFL007**

materiál: hliník  
COB LED 5W / WW  
Ra85 / 500lm  
obsahuje zdroj  
IP44 / class I / **CE**  
černá  
3000k/ 4000k/ 6000k

● **LFL008**

materiál: hliník  
COB LED 5W / WW  
Ra85 / 500lm  
obsahuje zdroj  
IP44 / class I / **CE**  
černá  
3000k/ 4000k/ 6000k





● **LFL018**

materiál: hliník CREE  
LED 3W / WW Ra85  
/ 170lm  
bez zdroje  
IP44 / class III /   
černá  
3000k/ 4000k/ 6000k

● **LFL017**

materiál: hliník  
CREE LED 3W / WW  
Ra85 / 170lm  
bez zdroje  
IP44 / class III /   
černá  
3000k/ 4000k/ 6000k

● **LFL016**

materiál: hliník  
CREE LED 3W / WW  
Ra85 / 170lm  
bez zdroje  
IP44 / class III /   
černá  
3000k/ 4000k/ 6000k

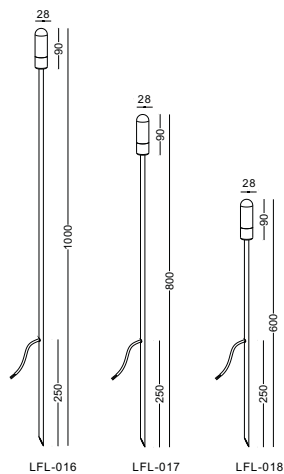

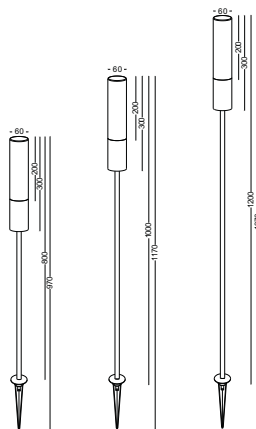

- **LFL013**  
 materiál: hliník  
 COB LED 5W / WW  
 Ra85 / 500lm  
 obsahuje zdroj  
 IP44 / class I / **CE**  
 černá  
 3000k/ 4000k/ 6000k

- **LFL014**  
 materiál: hliník  
 COB LED 5W / WW  
 Ra85 / 500lm  
 obsahuje zdroj  
 IP44 / class I / **CE**  
 černá  
 3000k/ 4000k/ 6000k

- **LFL015**  
 materiál: hliník  
 COB LED 5W / WW  
 Ra85 / 500lm  
 obsahuje zdroj  
 IP44 / class I / **CE**  
 černá  
 3000k/ 4000k/ 6000k

VENKOVNÍ ZAPUŠTĚNÁ  
STROPNÍ SVÍTIDLA

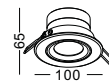

● LDC335

materiál: hliník  
CREE COB 5W / WW  
Ra80 / 500lm/38 stupňů  
bez zdroje  
IP65 / class III /  $\text{CE}$   
černá  
3000k/4000k/6000k  
průměr výřezu 80mm

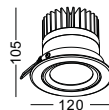

● LDC336

materiál: hliník  
CREE COB 9W / WW  
Ra80 / 900lm/38 stupňů  
bez zdroje IP65 /  
class III /  $\text{CE}$   
černá  
3000k/4000k/6000k  
průměr výřezu 100mm

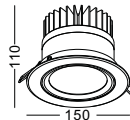

● LDC337

materiál: hliník  
CREE COB 12W / WW  
Ra80 / 1200lm/38 stupňů  
bez zdroje  
IP65 / class III /  $\text{CE}$   
černá  
3000k/4000k/6000k  
průměr výřezu 125mm



VENKOVNÍ  
POVRCHOVÁ  
STROPNÍ SVÍTIDLA



● LBL183



materiál: hliník  
CREE COB 5W / WW  
Ra80 / 500lm/38 stupňů  
obsahuje zdroj  
IP44 / class I /  $\text{CE}$   
černá  
3000k/4000k/ 6000k

● LBL184

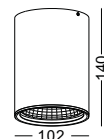

materiál: hliník  
CREE COB 12W / WW  
Ra80 / 1200lm/38 stupňů  
obsahuje zdroj  
IP44 / class I /  $\text{CE}$   
černá  
3000k/4000k/6000k

● LBL185



materiál: hliník  
CREE COB 20W / WW  
Ra80 / 2000lm/38 stupňů  
obsahuje zdroj  
IP44 / class I /  $\text{CE}$   
černá  
3000k/4000k/6000k



VENKOVNÍ  
POVRCHOVÁ  
STROPNÍ SVÍTIDLA



● **LBL186**

materiál: hliník  
CREE COB 5W / WW  
Ra80 / 500lm/38 stupňů  
obsahuje zdroj  
IP44 / class I / **CE**  
černá  
3000k/4000k/ 6000k

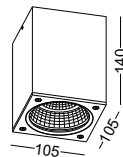

● **LBL187**

materiál: hliník CREE COB  
12W / WW  
Ra80 / 1200lm/ 38 stupňů  
obsahuje zdroj  
IP44 / class I / **CE**  
černá  
3000k/ 4000k/ 6000k

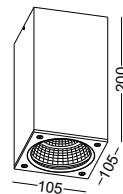

● **LBL188**

materiál: hliník  
CREE COB 20W / WW  
Ra80 / 2000lm / 38 stupňů  
obsahuje zdroj  
IP44 / class I / **CE**  
černá  
3000k/4000k/6000k



[www.LUXIFER.cz](http://www.LUXIFER.cz)

SHOWROOM: Škrétova 4, Praha 2