















**Parts needed to assemble and mount the M12 fastener set**

- Top nut (N) 
- Locking washer (M) 
- Power connector (L) 
- Bottom nut (K) 
- Metal washer (J) 
- Top washer (I) 
- Bottom washer (H) 
- Hollow rod (G) 
- Top head (F) 
- Arm (E) 
- Bottom head (D) 
- Plastic base (C) 
- Plastic bolt (B) 
- Head cable (A) 

**Tools needed for mounting:**

- Allen wrench
- drill
- pliers

**NOTE!** A list of products corresponding with the selected accessories is available at [www.klusdesign.eu/uk](http://www.klusdesign.eu/uk).

**1.** Drill a hole with a diameter of 10 mm in the mounting surface. The hole must be next to the cable with a single pole. Connect the end of the cable to the power connector (L).

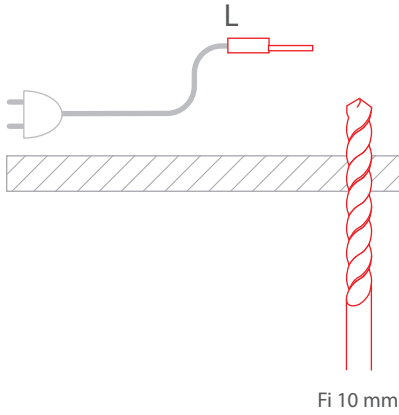

**2.** Insert the hollow rod (G) into the drilled hole. From the inside, put on in sequence: top washer (I), metal washer (J), bottom nut (K), power connector, locking washer (M) and top nut (N).

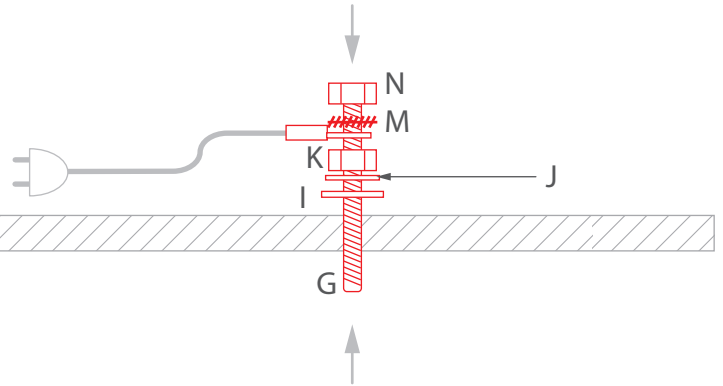

**3.** Put the bottom washer (H) and top head (F) on the bottom part of the hollow rod.

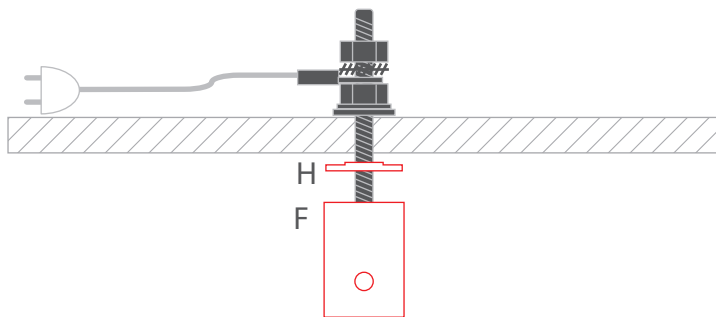

**4.** Drill a hole with a diameter of 5 mm in the selected extrusion.

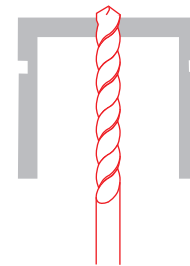

**5.** Bevel the hole so that the plastic bolt head fits in.

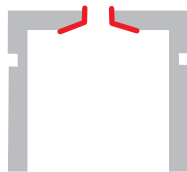

**6.** Mount the plastic bolt (B), on the top of put the plastic base (C) and conductive head (D).

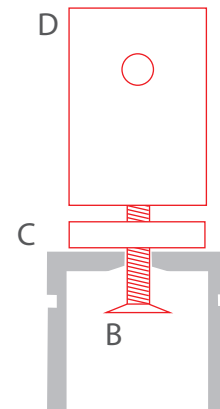

**7.** Run the cable (A) through the hole in the plastic bolt and connect power to the LED strip.

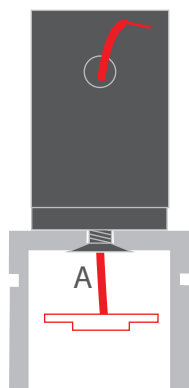

**8.** Insert the arm (E) into the mounting bracket of the head. It must press the power cable. Block the arm by tightening the pressure screw in the head with the Allen wrench.

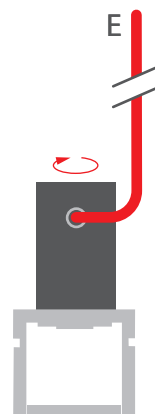

**9.** Attach the lighting fixture with the arm (E) to the top head (F). Block the rod by tightening the pressure screw in the top head with the Allen wrench.

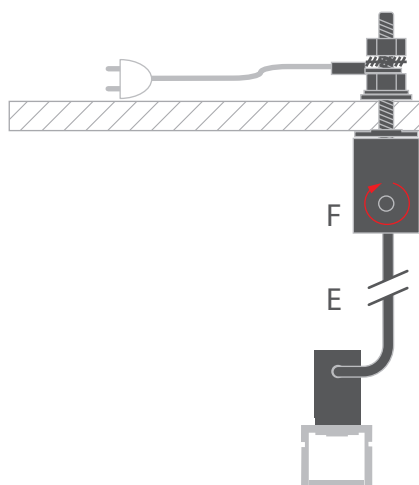

**10. NOTE!** The position of the lighting fixture on the arm can be adjusted in the range of 360° (depending on the distance of the fastener from the edge of the extrusion).

