

PDS-STN-45D Mounting bracket

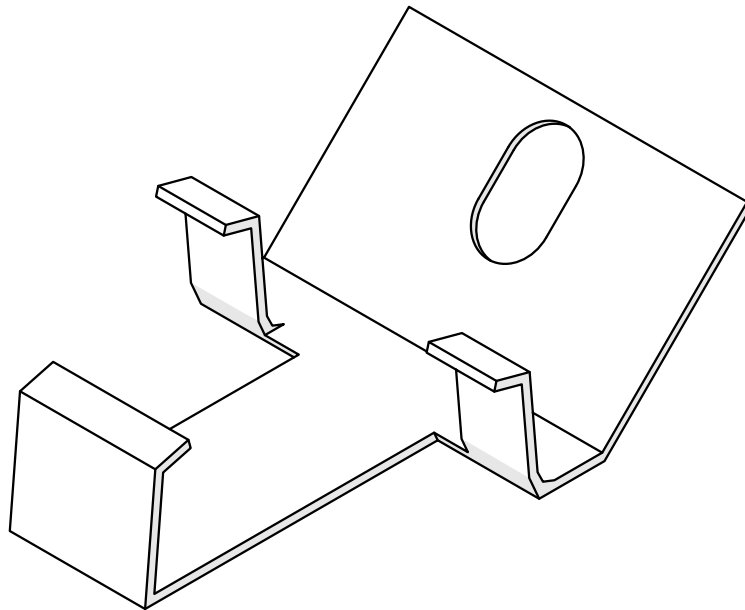

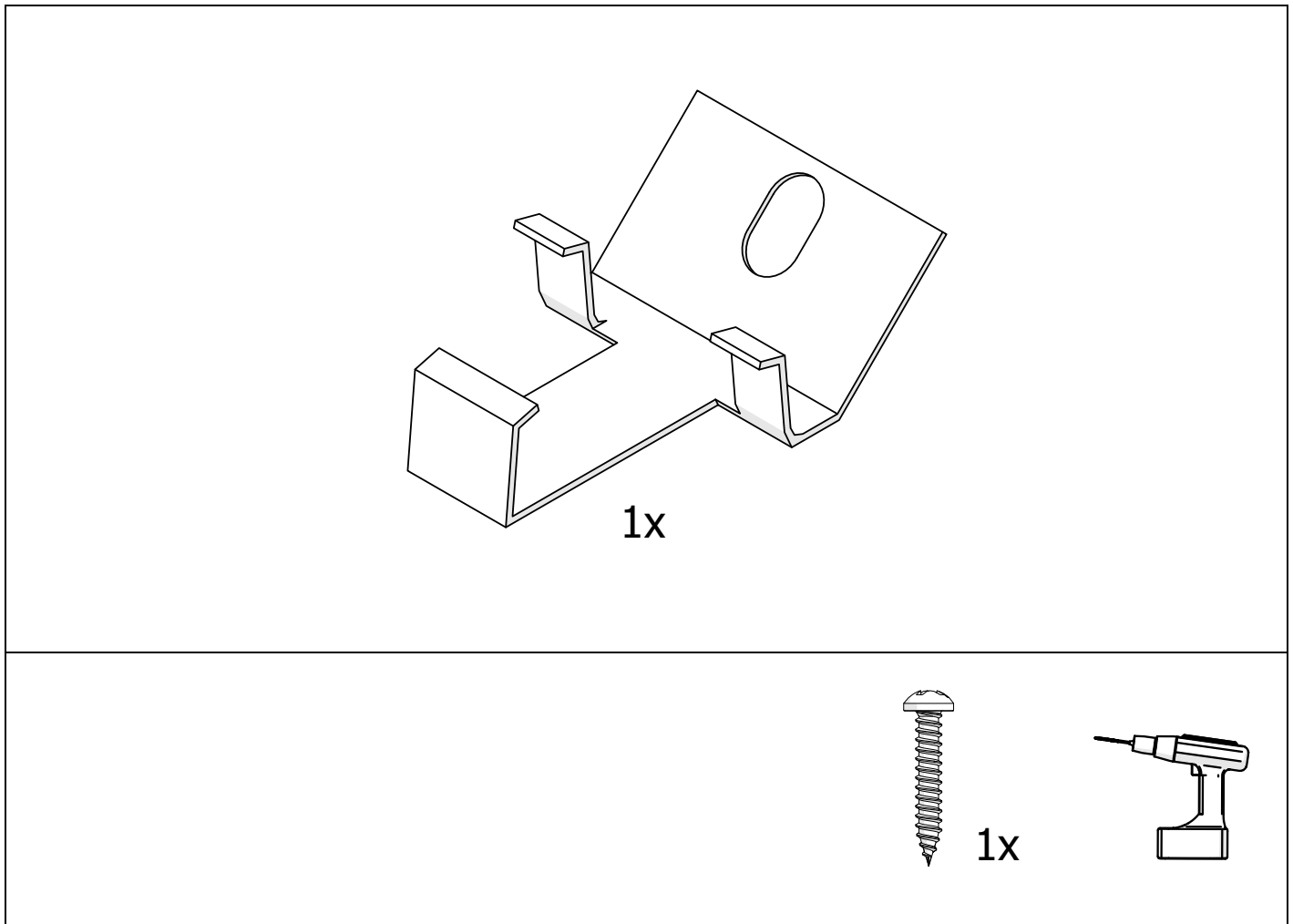

PDS-STN-45D Mounting bracket (ref. 24456)

IMPORTANT: Not all possible mounting procedures are presented here. More mounting procedures and related accessories can be found at www.KlusDesign.eu. Drawings in these instructions are simplified and only approximate the actual shapes.

I

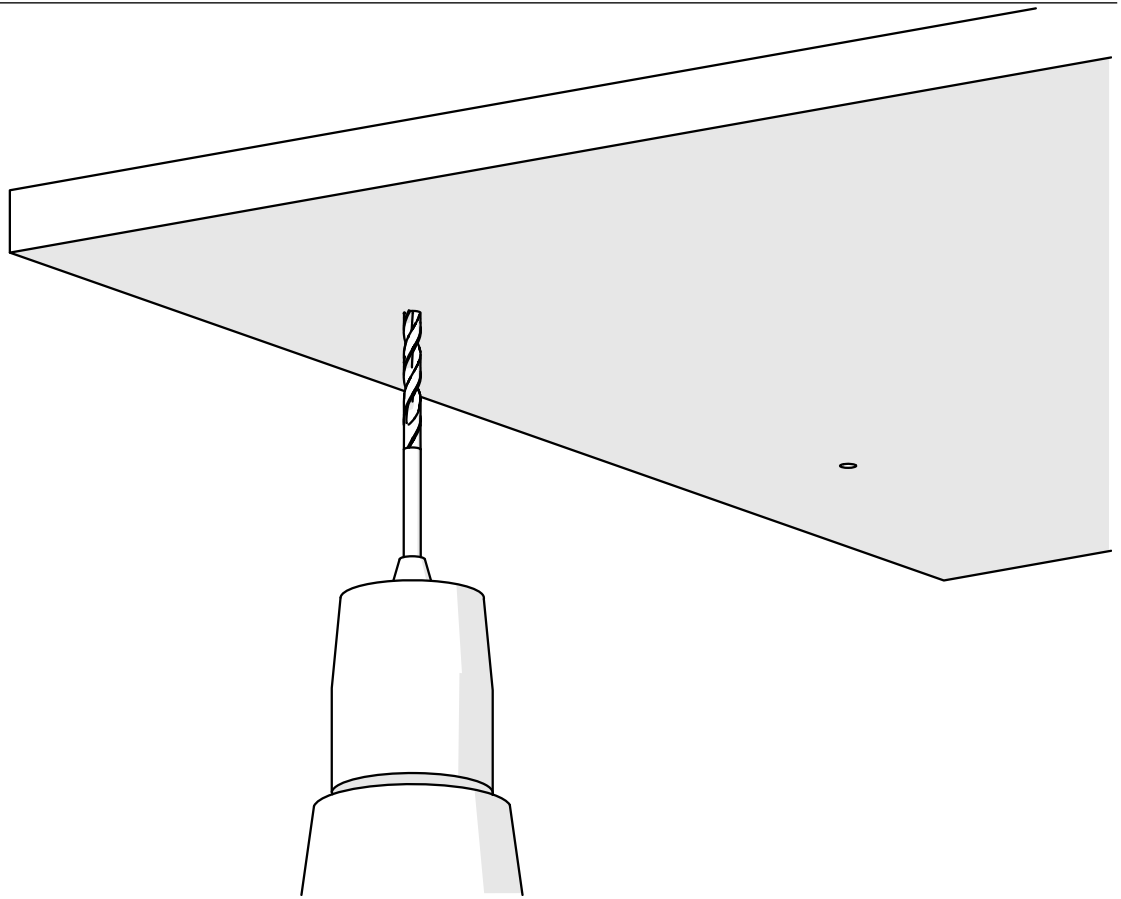

II

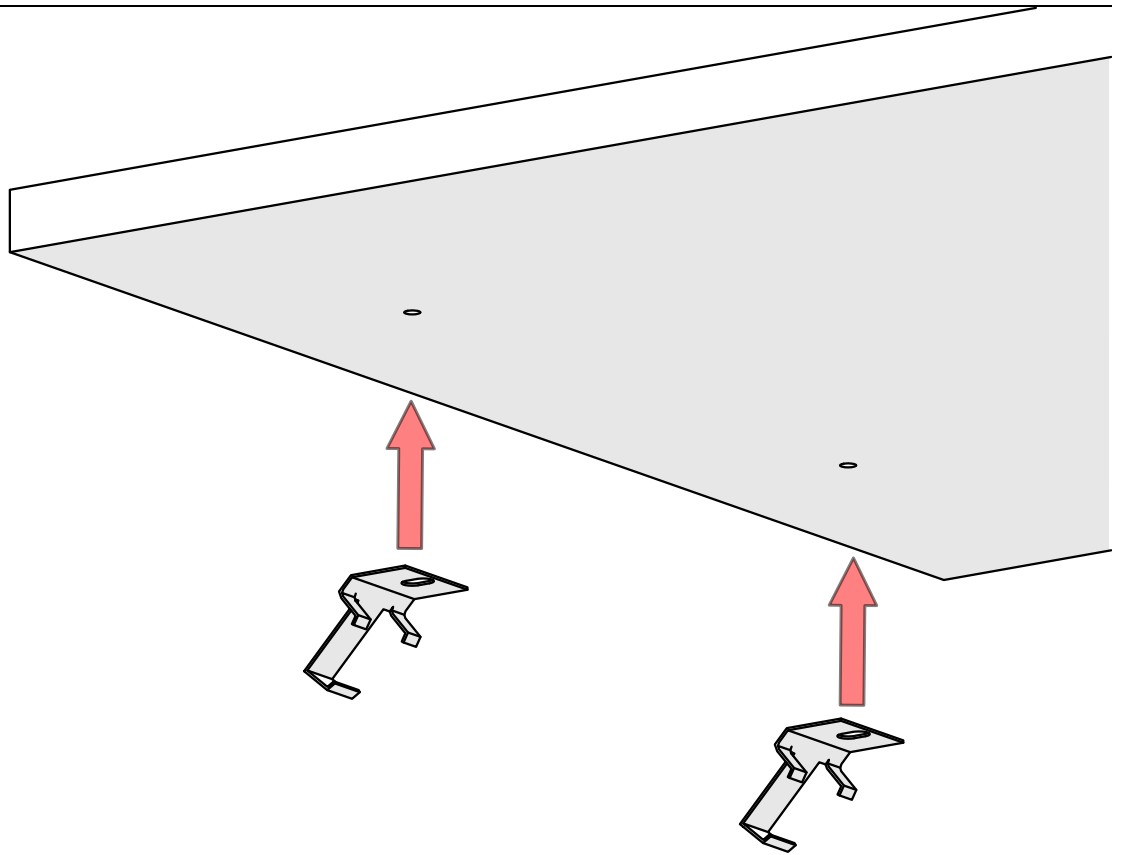

III

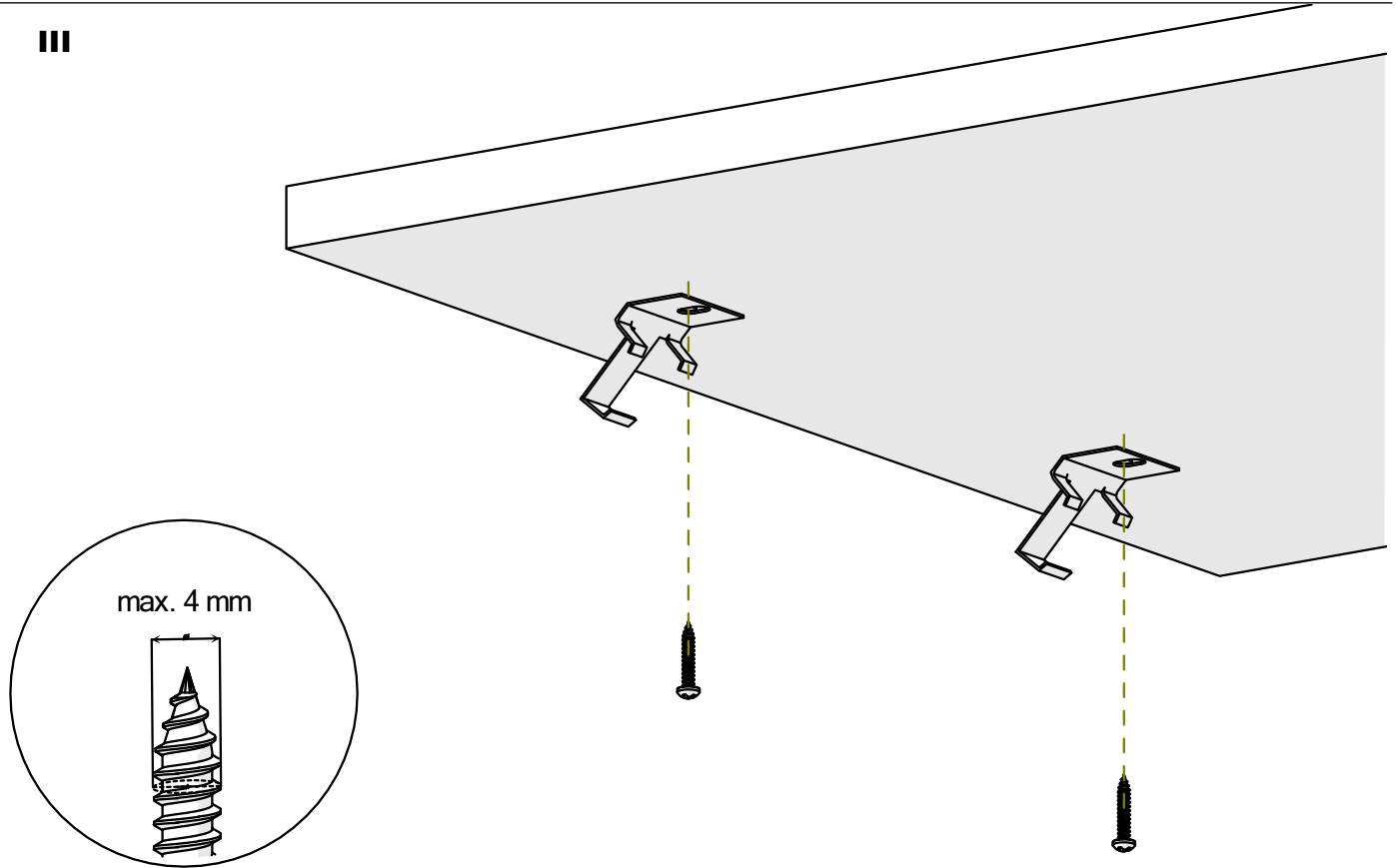

IV

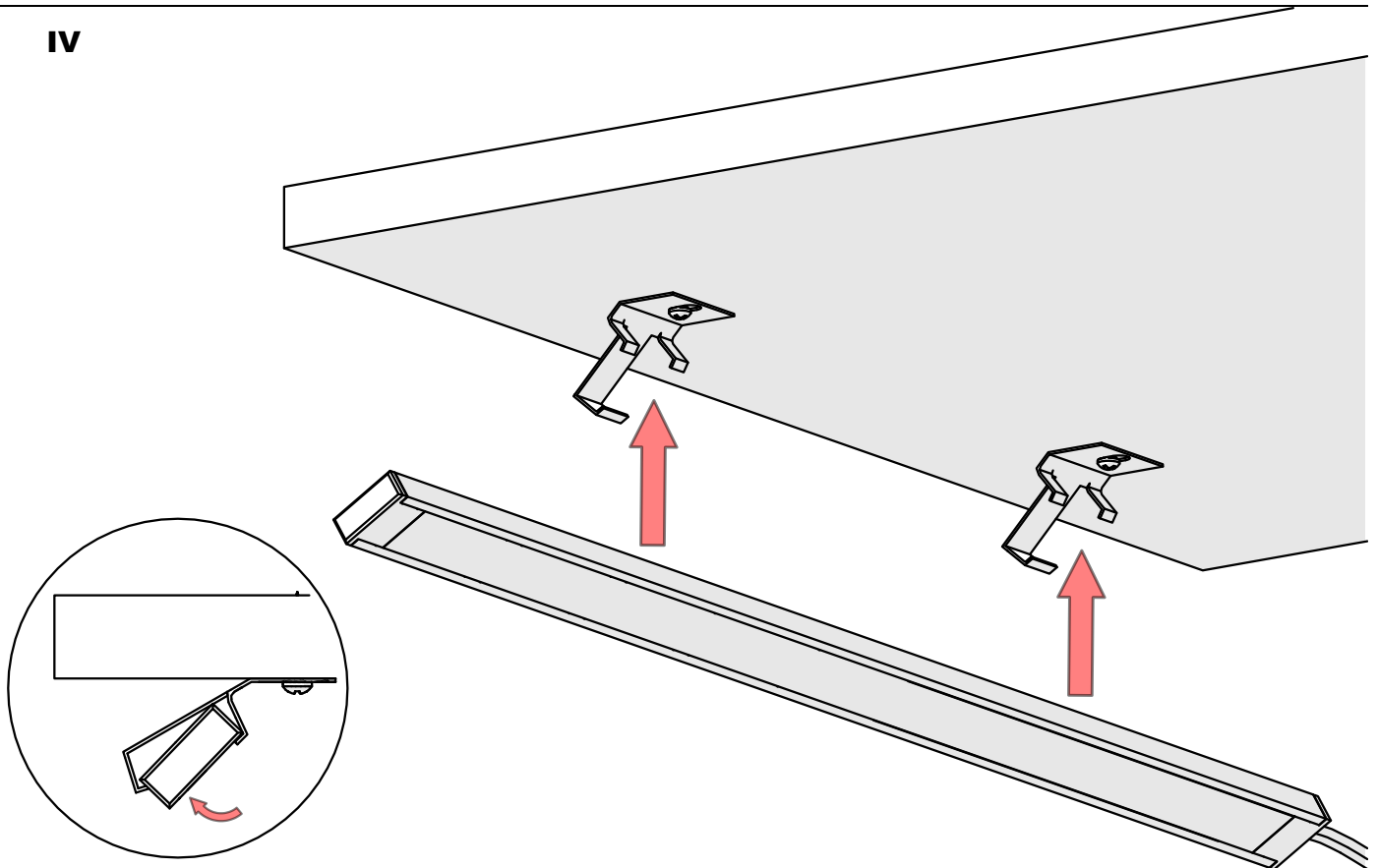

V

