

Závěska FI-10-ZM-P

Ref. C28117N00

Ref. arch 42244

- Příčné zavěšení na proutku nebo lanku
- Malé rozměry

ÚČEL PRODUKTU

- k zavěšení LED svítidel

INSTALACE

- k tyči nebo lanku pomocí stavěcího šroubu
- do tyče pomocí aretačního šroubu



TECHNICKÝ VÝKRES

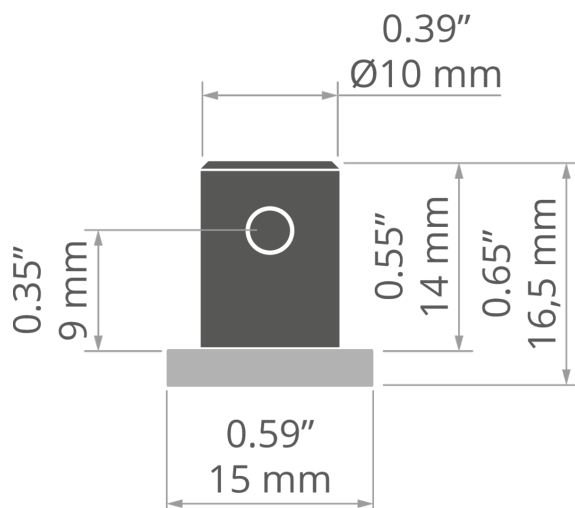

TECHNICKÁ SPECIFIKACE

Materiál	nerezová ocel
Barva	■ stříbrná
Šířka	15 mm

Výška	16,5 mm
Nosnost	30 kg

SOUVISEJÍCÍ PROFILY > ARCHITEKTONICKÉ



3035
A18039
Ref. arch 18039



3035-O
A08441
Ref. arch B8441

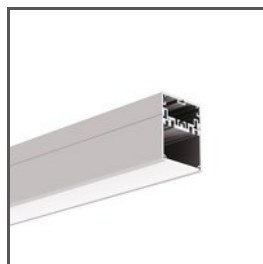

4050
A18050
Ref. arch 18050



4050-W
A18051
Ref. arch 18051



GIZA
A05556
Ref. arch B5556

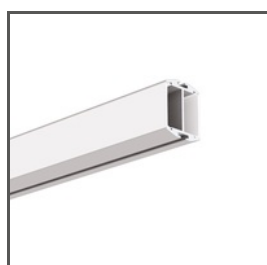

GIZA-DUO-LL
A02162
Ref. arch C2162



GIZA-LL
A00758
Ref. arch C0758

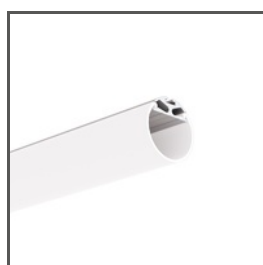

JAZ
A08547
Ref. arch B8547

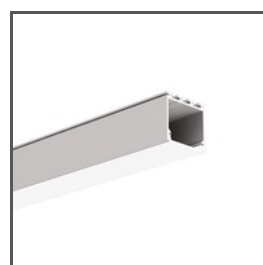

LIPOD
A05554
Ref. arch B5554



OPK-4
A00370
Ref. arch C0370

SOUVISEJÍCÍ PROFILY > MINIMALISTICKÉ



PIKO-ZM
A01168
Ref. arch C1168

SOUVISEJÍCÍ PROFILY > PRO HLAVNÍ OSVĚTLENÍ

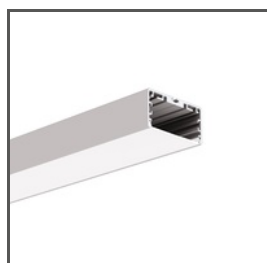

LIPOD-50
A02609
Ref. arch C2609

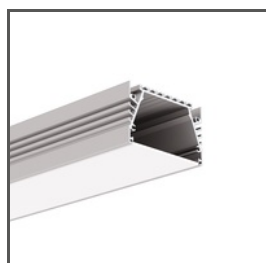

SEPOD
A06593
Ref. arch B6593

SOUVISEJÍCÍ PROFILY > UNIVERZÁLNÍ



OLEK

A08505

Ref. arch B8505



PDS-ZM-PLUS

A02056

Ref. arch C2056

SOUVISEJÍCÍ SYSTÉMY > PRO OBECNÉ OSVĚTLENÍ

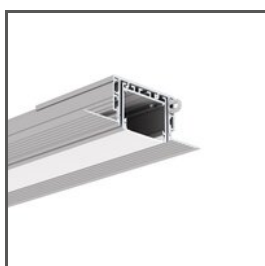

3035-KOZE

A08441+A18056

Ref. arch 18056+B8441



PK-4

A18044+A00370

Ref. arch 18044+C0370

SOUVISEJÍCÍ PŘÍSLUŠENSTVÍ > JINÉ PŘÍSLUŠENSTVÍ > LANKA A TYČE

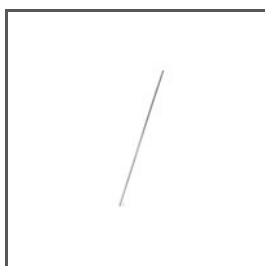

PRUT

FI-3 1m

42501

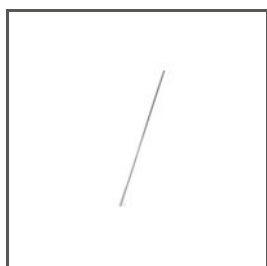

PRUT

100 PUSZ 1 m

42518

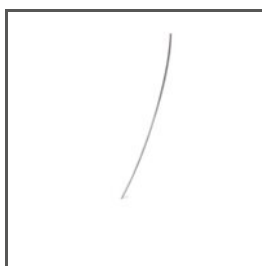

PRUT

FI-3 53 cm

C24528N00

Ref. arch 1528



PRUT

FI-3-ALU

C28196A01, C28196A07

Ref. arch 42526, 42527, 42528, 42529