

PRODUCT DESCRIPTION

Standard conductive fastener for light-weight fixtures. Power is supplied outside the fastener to a power connector. One current pole is powered from one fastener that is equipped with a LONGITUDINAL Hole for the FI-3 ROD, which acts as a power conductor

Fill empty fields

Product nr.

Fixture type

Company

Job name

Date

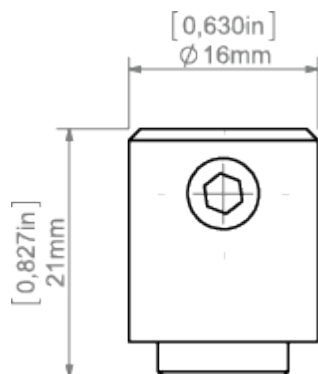
**TECHNICAL SPECIFICATION****TECHNICAL DRAWING**

RELATED PROFILES

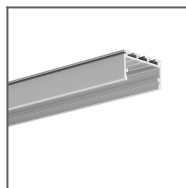

GIZA-LL profile
Ref: C0758

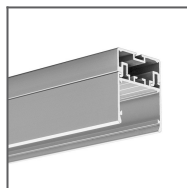

3035 Profile
Ref: 18039



JAZ Profile
Ref: B8547

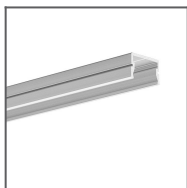

SILER Profile
Ref: B9325

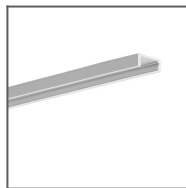

MICRO-ALU Profile
Ref: B1888

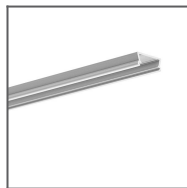

TAMI Profile
Ref: B5390

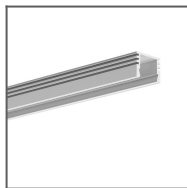

PDS-4-ALU Profile
Ref: B1718



PDS-ZM Profile
Ref: B7696

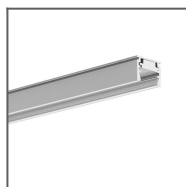

REGULOR Profile
Ref: B468+43

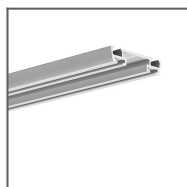

TEST-74 Profile
Ref: W4507

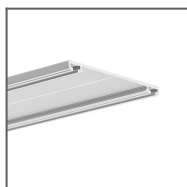

TETRA-43 Profile
Ref: W4476

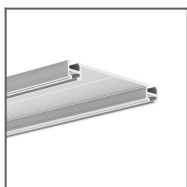

TETRA-78 Profile
Ref: W4508

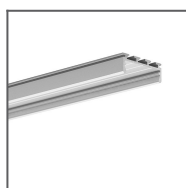

GIZA Profile
Ref: B5556

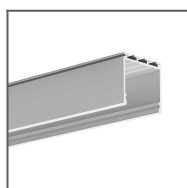

LIPOD Profile
Ref: B5554

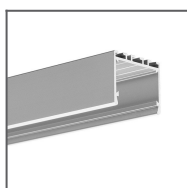

3035-O Profile
Ref: B8441



PDS-4-PLUS
Profile
Ref: C1263

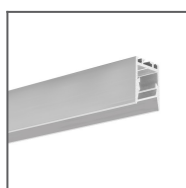

PDS-ZMG Profile
Ref: C1418

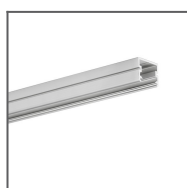

TAPO Profile
Ref: C1919

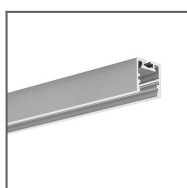

PDS-ZM-PLUS
Profile
Ref: C2056

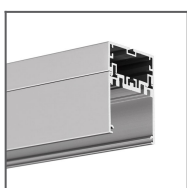

4050 Profile
Ref: 18050

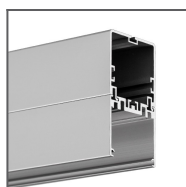

4050-W Profile
Ref: 18051

RELATED PRODUCTS

ACCESSORIES



100 PUSZ brass
chrome Rod 1 m
Ref: 42518

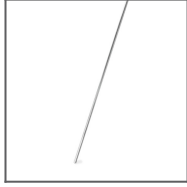

Brass chrome FI-3
Rod 1m
Ref: 42501

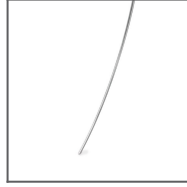

Steel FI-3 Rod 53
cm
Ref: 1528

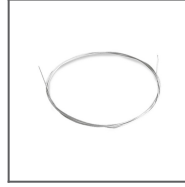

Steel wire FI-1 1m
Ref: 1397