

PRODUCT DESCRIPTION

A head for mounting lightweight lighting fixtures on wall arms mounted directly to the extrusion

Fill empty fields

Product nr.
Fixture type
Company
Job name
Date



TECHNICAL SPECIFICATION

TECHNICAL DRAWING

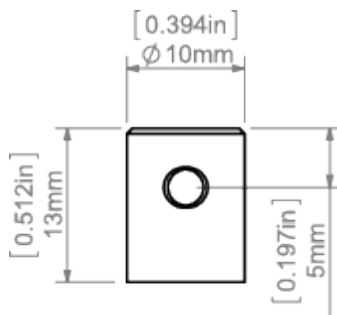

RELATED PROFILES

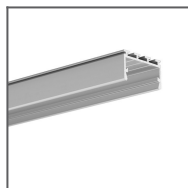

GIZA-LL profile
Ref: C0758

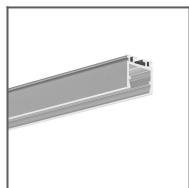

OPK-4 Profile
Ref: C0370

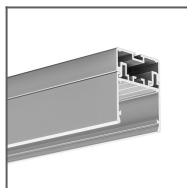

3035 Profile
Ref: 18039



JAZ Profile
Ref: B8547

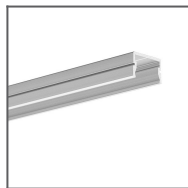

SILER Profile
Ref: B9325

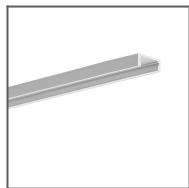

MICRO-ALU Profile
Ref: B1888

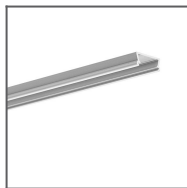

TAMI Profile
Ref: B5390

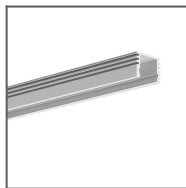

PDS-4-ALU Profile
Ref: B1718

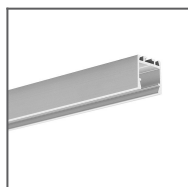

PDS-ZM Profile
Ref: B7696

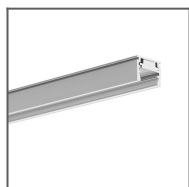

REGULOR Profile
Ref: B468+43

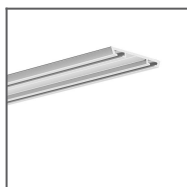

TEST-36 Profile
Ref: B6639

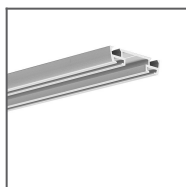

TEST-74 Profile
Ref: W4507

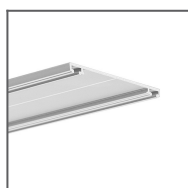

TETRA-43 Profile
Ref: W4476

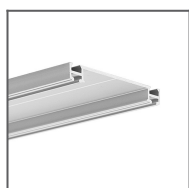

TETRA-78 Profile
Ref: W4508

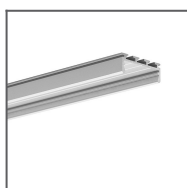

GIZA Profile
Ref: B5556

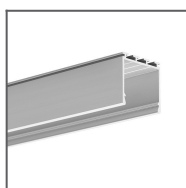

LIPOD Profile
Ref: B5554

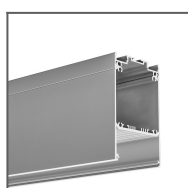

DES Profile
Ref: 18030

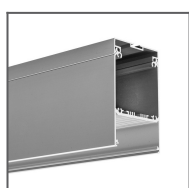

GLADES Profile
Ref: 18036

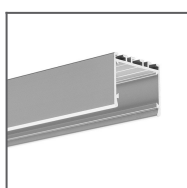

3035-O Profile
Ref: B8441

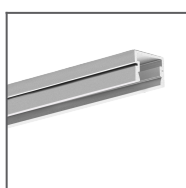

PDS-4-PLUS
Profile
Ref: C1263

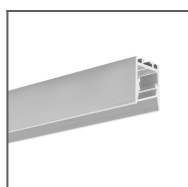

PDS-ZMG Profile
Ref: C1418

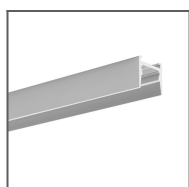

MICRO-HG Profile
Ref: C1419

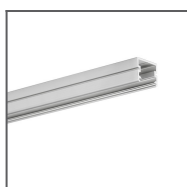

TAPO Profile
Ref: C1919

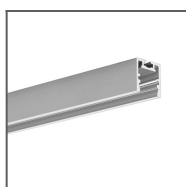

PDS-ZM-PLUS
Profile
Ref: C2056

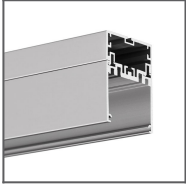

4050 Profile
Ref: 18050

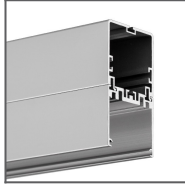

4050-W Profile
Ref: 18051

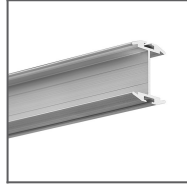

GIZA-DUO-LL
Profile
Ref: C2162

RELATED PRODUCTS

ACCESSORIES

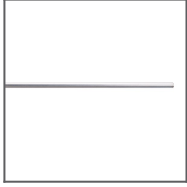

K0-AB Arm
Ref: 42101

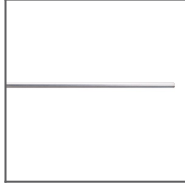

K0-AB300 Arm
Ref: 42202

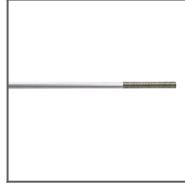

K0G-AB Arm
Ref: 42102

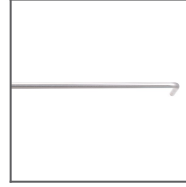

K1-AB Arm
Ref: 42113

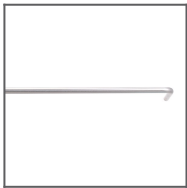

K1-AB300 Arm
Ref: 42201

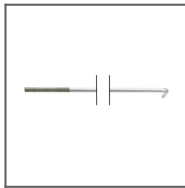

K1G-AB Arm
Ref: 42115

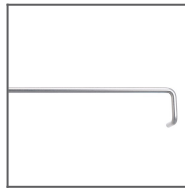

K2-AB Arm
Ref: 42114

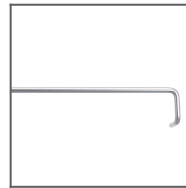

K2-AB300 Arm
Ref: 42200



K2G-AB Arm
Ref: 42116



K5G-AB Arm
Ref: 42051



M5-K5 Rod 1m
Ref: 42209