

PRODUCT DESCRIPTION

A head for mounting lightweight lighting fixtures on wall arms. Mounted directly to the profile. It includes an external power connector for connecting power to a single pole of electricity

Fill empty fields

Product nr.

Fixture type

Company

Job name

Date

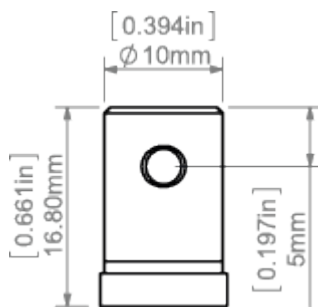
**TECHNICAL SPECIFICATION****TECHNICAL DRAWING**

RELATED PROFILES

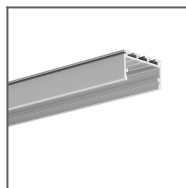

GIZA-LL profile
Ref: C0758

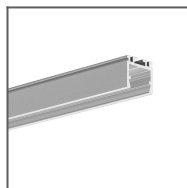

OPK-4 Profile
Ref: C0370

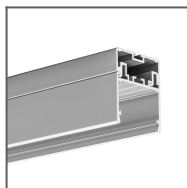

3035 Profile
Ref: 18039



JAZ Profile
Ref: B8547

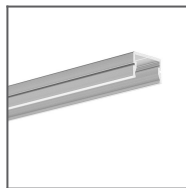

SILER Profile
Ref: B9325

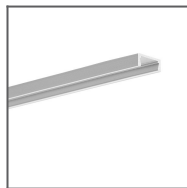

MICRO-ALU Profile
Ref: B1888

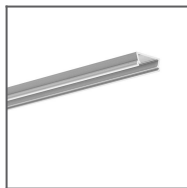

TAMI Profile
Ref: B5390



PDS-4-ALU Profile
Ref: B1718

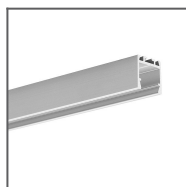

PDS-ZM Profile
Ref: B7696

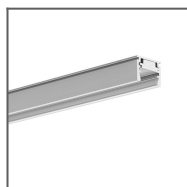

REGULOR Profile
Ref: B468+43

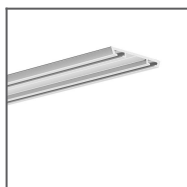

TEST-36 Profile
Ref: B6639



TEST-74 Profile
Ref: W4507

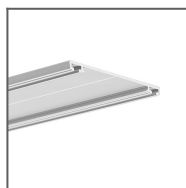

TETRA-43 Profile
Ref: W4476

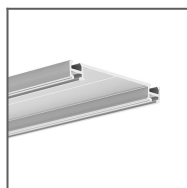

TETRA-78 Profile
Ref: W4508

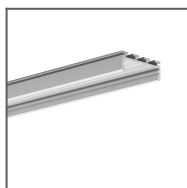

GIZA Profile
Ref: B5556

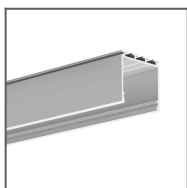

LIPOD Profile
Ref: B5554

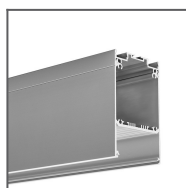

DES Profile
Ref: 18030

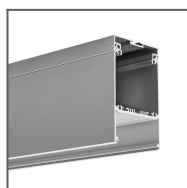

GLADES Profile
Ref: 18036

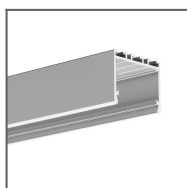

3035-O Profile
Ref: B8441

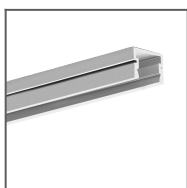

PDS-4-PLUS
Profile
Ref: C1263

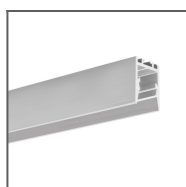

PDS-ZMG Profile
Ref: C1418

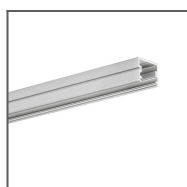

TAPO Profile
Ref: C1919

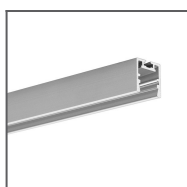

PDS-ZM-PLUS
Profile
Ref: C2056

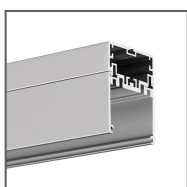

4050 Profile
Ref: 18050

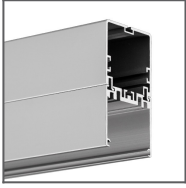

4050-W Profile
Ref: 18051

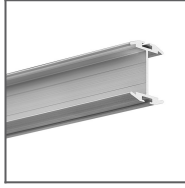

GIZA-DUO-LL
Profile
Ref: C2162

RELATED PRODUCTS

ACCESSORIES

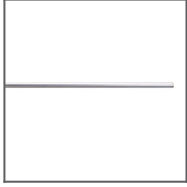

K0-AB Arm
Ref: 42101

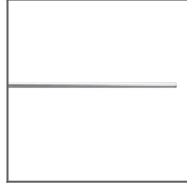

K0-AB300 Arm
Ref: 42202

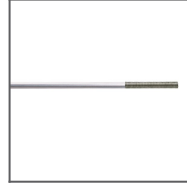

K0G-AB Arm
Ref: 42102

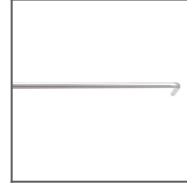

K1-AB Arm
Ref: 42113

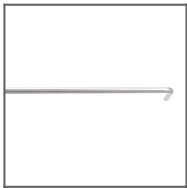

K1-AB300 Arm
Ref: 42201

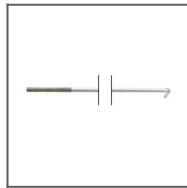

K1G-AB Arm
Ref: 42115

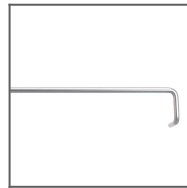

K2-AB Arm
Ref: 42114

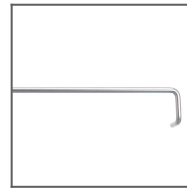

K2-AB300 Arm
Ref: 42200



K2G-AB Arm
Ref: 42116



K5G-AB Arm
Ref: 42051



M5-K5 Rod 1m
Ref: 42209