

## 60 & 40 W, Efficient, Compact Non-Dimmable CV Class 2 / Class II LED Drivers

| Nominal Input Voltage         | Max. Output Power | Nominal Output Voltage | Max. Output Current | Efficiency        | Max. Case Temperature           | THD   | Power Factor |
|-------------------------------|-------------------|------------------------|---------------------|-------------------|---------------------------------|-------|--------------|
| 120 & 277 Vac, 220 to 240 Vac | 60 W              | 12, 24, 48 Vdc         | 5, 2.5, 1.25 A      | up to 90% typical | 90°C (measured at the hot spot) | < 20% | > 0.9        |

**Models with Flying Leads, Aluminum Case (VLMXXW Models):**

L 130.0 x W 19.65 x H 19.8 mm  
(L 5.12 x W 0.77 x H 0.78 in)  
VLMXXE dimensions on page 14

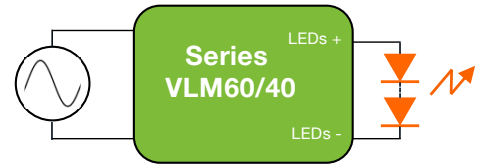

Typical Application Diagram

**Models with “-S” Suffix, Bottom Leads with Studs, Aluminum Case:**

L 130 x W 19.65 x H 23.85 mm  
(L 5.12 x W 0.77 x H 0.94 in)

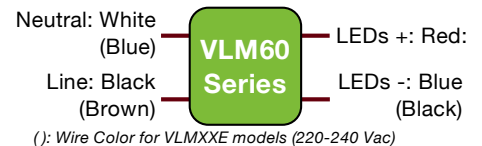
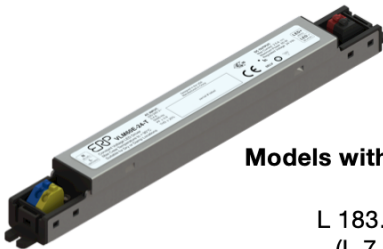

( ): Wire Color for VLMXXE models (220-240 Vac)

Wiring Diagram

**Models with “-T” Suffix (Terminal Blocks), Aluminum Case:**

L 183.2 x W 19.9 x H 19.85 mm  
(L 7.12 x W 0.78 x H 0.78 in)

**FEATURES**

- Very high power density of 20 W/in<sup>3</sup>
- Class 2 power supply
- Class II power supply per IEC 61347
- IP20-rated case with silicone-based potting
- 90°C maximum case hot spot temperature
- Complies with ENERGY STAR®, DLC (DesignLight Consortium®) and CA Title 24 technical requirements
- Lifetime: 50,000 hours min at 70°C case temperature
- UL Class P
- Worldwide safety approvals SELV Class 2
- Additional safety approvals when using the optional strain reliefs for models with “-T” suffix

CA Title 24



**Note:** The VLM series is a dedicated constant voltage LED driver. Some alternative loads may have large input capacitance or other drive current demands not compatible for use with the VLM series. The performance of the VLM series must be tested and qualified thoroughly when being used to drive alternative electronic circuit loads other than LED loads. The VLM series drivers are designed and characterized to be compatible with Lumenetix brand light engines.



# VLM60/40 Series

**VLM60 60 W**  
**VLM40 40 W**

## 60 & 40 W, Efficient, Compact Non-Dimmable CV Class 2 / Class II LED Drivers

### 1 - ORDERING INFORMATION

|                              | ERP Part Number | Nominal Input Voltage (Vac) | Pout Max (W) | Vout Nom (Vdc) | Iout Min (A) | Iout Max (A) | Open Loop Voltage (No Load Vout Max) (Vdc) | Comments                                  | Safety, EMC Compliance |
|------------------------------|-----------------|-----------------------------|--------------|----------------|--------------|--------------|--|---|------------------------|
| 120 & 277 VAC NOMINAL INPUT  | <b>VLM40W</b>   |                             |              |                |              |              |  |   |                        |
|                              | VLM40W-12       | 120 & 277                   | 40           | 12             | 0.1          | 3.3          | 12.84                                      | Aluminum case with flying leads           | UL, cUL, FCC           |
|                              | VLM40W-24       | 120 & 277                   | 40           | 24             | 0.05         | 1.67         | 25.68                                      | Aluminum case with flying leads           | UL, cUL, FCC           |
|                              | VLM40W-48       | 120 & 277                   | 40           | 48             | 0.025        | 0.83         | 51.36                                      | Aluminum case with flying leads           | UL, cUL, FCC           |
|                              | VLM40W-12-S     | 120 & 277                   | 40           | 12             | 0.1          | 3.3          | 12.84                                      | Aluminum case with bottom leads and studs | UL, cUL, FCC           |
|                              | VLM40W-24-S     | 120 & 277                   | 40           | 24             | 0.05         | 1.67         | 25.68                                      | Aluminum case with bottom leads and studs | UL, cUL, FCC           |
|                              | VLM40W-48-S     | 120 & 277                   | 40           | 48             | 0.025        | 0.83         | 51.36                                      | Aluminum case with bottom leads and studs | UL, cUL, FCC           |
|                              | <b>VLM60W</b>   |                             |              |                |              |              |  |   |                        |
|                              | VLM60W-12       | 120 & 277                   | 60           | 12             | 0.1          | 5            | 12.84                                      | Aluminum case with flying leads           | UL, cUL, FCC           |
|                              | VLM60W-24       | 120 & 277                   | 60           | 24             | 0.05         | 2.5          | 25.68                                      | Aluminum case with flying leads           | UL, cUL, FCC           |
|                              | VLM60W-48       | 120 & 277                   | 60           | 48             | 0.025        | 1.25         | 51.36                                      | Aluminum case with flying leads           | UL, cUL, FCC           |
|                              | VLM60W-12-S     | 120 & 277                   | 60           | 12             | 0.1          | 5            | 12.84                                      | Aluminum case with bottom leads and studs | UL, cUL, FCC           |
| VLM60W-24-S                  | 120 & 277       | 60                          | 24           | 0.05           | 2.5          | 25.68        | Aluminum case with bottom leads and studs  | UL, cUL, FCC                              |                        |
| VLM60W-48-S                  | 120 & 277       | 60                          | 48           | 0.025          | 1.25         | 51.36        | Aluminum case with bottom leads and studs  | UL, cUL, FCC                              |                        |
| 220 to 240 VAC NOMINAL INPUT | <b>VLM40E</b>   |                             |              |                |              |              |  |   |                        |
|                              | VLM40E-12-T     | 220 to 240                  | 40           | 12             | 0.1          | 3.3          | 12.84                                      | Aluminum case with terminal blocks        | CB, ENEC,CE            |
|                              | VLM40E-24-T     | 220 to 240                  | 40           | 24             | 0.05         | 1.67         | 25.68                                      | Aluminum case with terminal blocks        | CB, ENEC,CE            |
|                              | VLM40E-48-T     | 220 to 240                  | 40           | 48             | 0.025        | 0.83         | 51.36                                      | Aluminum case with terminal blocks        | CB, ENEC,CE            |
|                              | <b>VLM60E</b>   |                             |              |                |              |              |  |   |                        |
|                              | VLM60E-24       | 220 to 240                  | 60           | 24             | 0.05         | 2.5          | 25.68                                      | Aluminum case with flying leads           | CB, ENEC,CE            |
|                              | VLM60E-48       | 220 to 240                  | 60           | 48             | 0.025        | 1.25         | 51.36                                      | Aluminum case with flying leads           | CB, ENEC,CE            |
|                              | VLM60E-12-T     | 220 to 240                  | 60           | 12             | 0.1          | 5            | 12.84                                      | Aluminum case with terminal blocks        | CB, ENEC,CE            |
|                              | VLM60E-24-T     | 220 to 240                  | 60           | 24             | 0.05         | 2.5          | 25.68                                      | Aluminum case with terminal blocks        | CB, ENEC,CE            |
| VLM60E-48-T                  | 220 to 240      | 60                          | 48           | 0.025          | 1.25         | 51.36        | Aluminum case with terminal blocks         | CB, ENEC,CE                               |                        |

**Notes:**

1. Strain reliefs for "-T" models are not included and can be ordered separately using part number SR1. Order quantity for SR1 is per strain relief, and 2 strain reliefs are needed for each driver.

## 60 & 40 W, Efficient, Compact Non-Dimmable CV Class 2 / Class II LED Drivers

### 2 - INPUT SPECIFICATION (@25° C ambient temperature)

|   | Units  | Minimum  | Typical   | Maximum  | Notes   |
|---|--|--|-----------|--|---|
| <b>Input Voltage Range (Vin)</b><br>- VLMXXW models | Vac  | 90   | 120 & 277 | 305  | •The rated output voltage for each model is achieved at Vin≥105 Vac & at Vin≥249 Vac for VLMXXW models, and at Vin≥209 Vac for VLMXXE models.<br>•At maximum load, as specified in section 1. |
| - VLMXXE models                                     |  | 198  | 230       | 264  |   |
| <b>Input Frequency Range</b><br>- VLMXXW models     | Hz   | 47   | 60        | 63   |   |
| - VLMXXE models                                     |  | 47   | 50        | 53   |   |
| <b>Input Current (Iin)</b>                          | A  |  |           | 0.7 A @ 120 Vac<br>0.4 A @ 230 vac<br>0.3 A @ 277 Vac    |   |
| <b>Max Units on a 16 A Circuit Breaker</b>          |  | VLM40: 38 (120 Vac), 71 (230 Vac), 88 (277 Vac) units<br>VLM60: 25 (120 Vac), 48 (230 Vac), 59 (277 Vac) units |           |  | The maximum number of units allowed per 16 A circuit breaker is based on worst-case conditions at 100% output.  |
| <b>Power Factor (PF)</b>                            |  | 0.9  | > 0.9     |  | •At nominal input voltage<br>•From 100% to 60% of rated power   |
| <b>Inrush Current</b>                               | A  | Meets NEMA-410 requirements  |           |  | •At any point on the sine wave and 25°C   |
| <b>Leakage Current</b>                              | µA   |  |           | 400 µA @ 120 Vac<br>700 µA @ 230 Vac<br>920 µA @ 277 Vac | Measured per IEC60950-1   |
| <b>Input Harmonics</b>                              | Complies with IEC61000-3-2 for Class C equipment |  |           |  |   |
| <b>Total Harmonics Distortion (THD)</b>             |  |  |           | 20%  | •At nominal input voltage<br>•From 100% to 60% of rated power<br>•Complies with DLC (Design Light Consortium) technical requirements  |
| <b>Efficiency</b>                                   | %  | -  | up to 90% | -  | Measured with nominal input voltage   |
| <b>Isolation</b>                                    | The AC input to the main DC output is isolated.  |  |           |  |   |

### 3 - MAIN OUTPUT SPECIFICATION (@25° C ambient temperature)

|                                  | Units                                       | Minimum | Typical    | Maximum  | Notes  |
|----------------------------------|---|---------|------------|--|--|
| <b>Output Voltage (Vout)</b>     | Vdc   |         | 12, 24, 48 |  | See ordering information for details   |
| <b>Output Current (Iout)</b>     | A   |         |            | 12 Vdc: 5.0 A<br>24 Vdc: 2.5 A<br>48 Vdc: 1.25 A | The rated output voltage for each model is achieved at Vin≥105 Vac & at Vin≥249 Vac for VLMXXW models, and at Vin≥209 Vac for VLMXXE models.       |
| <b>Output Voltage Regulation</b> | %   | -5      |            | 5  | •At nominal AC line voltage<br>•Includes load and current set point variations.  |
| <b>Output Voltage Overshoot</b>  | %   | -       | -          | 10   | The driver does not operate outside of the regulation requirements for more than 500 ms during power on with maximum load.                         |
| <b>Ripple Voltage</b>            | ≤ 5% of rated output voltage for each model |         |            |  | •Measured at maximum load and nominal input voltage<br>•Calculated in accordance with the IES Lighting Handbook, 9th edition                       |
| <b>Start-up Time</b>             | ms  |         |            | 500  | •Measured from application of AC line voltage to 100% light output<br>•Complies with California Title 24 and ENERGY STAR® luminaire specification. |

## 60 & 40 W, Efficient, Compact Non-Dimmable CV Class 2 / Class II LED Drivers

### 4 - ENVIRONMENTAL CONDITIONS

|   | Units  | Minimum | Typical | Maximum | Notes   |
|---|--|---------|---------|---------|---|
| <b>Operating Ambient Temperature (Ta)</b> | °C   | -20     |         | 50      | 50°C is the non-derated temperature (Refer to section 7 "Output power de-rating at higher temperatures"). |
| <b>Maximum Case Temperature (Tc)</b>      | °C   |         |         | +90     | Case temperature measured at the hot spot •tc (see label in page 13)                                      |
| <b>Storage Temperature</b>                | °C   | -40     |         | +85     |   |
| <b>Humidity</b>                           | %  | 5       | -       | 95      | Non-condensing  |
| <b>Cooling</b>                            | Convection cooled  |         |         |         |   |
| <b>Acoustic Noise</b>                     | dBA  |         |         | 22      | Measured at a distance of 1 foot (30 cm)  |
| <b>Mechanical Shock Protection</b>        | per EN60068-2-27   |         |         |         |   |
| <b>Vibration Protection</b>               | per EN60068-2-6 & EN60068-2-64   |         |         |         |   |
| <b>MTBF</b>                               | > 200,000 hours when operated at nominal input and output conditions, and at Tc ≤ 70°C             |         |         |         |   |
| <b>Lifetime</b>                           | 50,000 hours at Tc ≤ 70°C maximum case hot spot temperature (see hot spot •tc on label in page 13) |         |         |         |   |

### 5 - EMC COMPLIANCE AND SAFETY APPROVALS

#### EMC Compliance

|   |  |                       |   |
|---|--|-----------------------|---|
| <b>Conducted and Radiated EMI</b>         | <ul style="list-style-type: none"> <li>•VLMXXW models: Compliant with FCC CFR Title 47 Part 15 Class B at 120 Vac &amp; Class A at 277 Vac</li> <li>•VLMXXE models: EN55015 (CISPR 15) compliant at 220, 230, and 240 Vac</li> </ul> |                       |   |
| <b>Harmonic Current Emissions</b>         | IEC61000-3-2   | For Class C equipment |   |
| <b>Voltage Fluctuations &amp; Flicker</b> | IEC61000-3-3   |                       |   |
| <b>Immunity Compliance</b>                | <b>ESD (Electrostatic Discharge)</b>   | IEC61000-4-2          | 6 kV contact discharge, 8 kV air discharge, level 3                         |
|   | <b>RF Electromagnetic Field Susceptibility</b>   | IEC61000-4-3          | 3 V/m, 80 - 1000 MHz, 80% modulated at a distance of 3 meters               |
|   | <b>Electrical Fast Transient</b>   | IEC61000-4-4          | ± 2 kV on AC power port for 1 minute, ±1 kV on signal/control lines         |
|   | <b>Surge</b>   | IEC61000-4-5          | ± 2 kV line to line (differential mode) / ± 2 kV line to common mode ground |
|   |  |                       | ANSI/IEEE c62.41.1-2002 & c62.41.2-2002 category A, 2.5 kV ring wave        |
|   | <b>Conducted RF Disturbances</b>   | IEC61000-4-6          | 3V, 0.15-80 MHz, 80% modulated  |
|   | <b>Voltage Dips</b>  | IEC61000-4-11         | >95% dip, 0.5 period; 30% dip, 25 periods; 95% reduction, 250 periods       |

#### Safety Agency Approvals

|             |   |
|-------------|---|
| <b>UL</b>   | VLMXXW models: UL8750 listed Class 2  |
| <b>cUL</b>  | VLMXXW models: CAN/CSA C22.2 No. 250.13-14 LED equipment for lighting applications              |
| <b>CE</b>   | VLMXXE models: IEC61347-2-13 electronic control gear for LED Modules & EN55015 (EMC compliance) |
| <b>CB</b>   | VLMXXE models   |
| <b>ENEC</b> | VLMXXE models   |

#### Safety

|   | Units | Minimum | Typical | Maximum | Notes   |
|---|-------|---------|---------|---------|---|
| <b>Hi Pot (High Potential) or Dielectric voltage-withstand</b><br>- VLMXXW models | Vdc   | 2500    |         |         | <ul style="list-style-type: none"> <li>•Insulation between the input (AC line and Neutral) and the output</li> <li>•Tested at the RMS voltage equivalent of 1768 Vac</li> </ul>   |
| - VLMXXE models   |       | 4242    |         |         | <ul style="list-style-type: none"> <li>•Tested at the RMS voltage equivalent of 3000 Vac</li> <li>•Meets class II reinforced/double insulation</li> </ul>  |

## 60 & 40 W, Efficient, Compact Non-Dimmable CV Class 2 / Class II LED Drivers

### 6 - PROTECTION FEATURES

#### Under-Voltage (Brownout)

The VLM60/40 series provides protection circuitry such that an application of an input voltage below the minimum stated in section 1 (Input Specification) shall not cause damage to the driver.

#### Short Circuit and Over Current Protection

The VLM60/40 series is protected against short-circuit such that a short from any output to return shall not result in a fire hazard or shock hazard. The driver shall hiccup as a result of a short circuit or over current fault. Removal of the fault will return the driver to within normal operation. The driver shall recover, with no damage, from a short across the output for an indefinite period of time.

#### Internal Over temperature Protection

The VLM60/40 is equipped with an internal temperature sensor on the primary power train. Failure to stay within the convection power rating will cause the driver to shut down. The main output current will be resumed when the temperature of the built-in temperature sensor cools adequately.

#### Output Open Load

A no load condition will not damage the VLM60/40 or cause a hazardous condition. The driver will remain stable and operate normally after application of a load. When the LED load is removed, the output voltage of the VLM60/40 series is limited to 7% about the output voltage of each model.

#### Over Power Protection

The VLM60/40 will shut down and auto recover when its input power exceeds approximately 110% of 96 W. This condition will cause no damage to the power supply.

#### Input Over Current Protection

The VLM60/40 series incorporates a primary AC line fuse for input over current protection.

### 7 - OUTPUT POWER DE-RATING AT ELEVATED TEMPERATURES

The VLM60/40 series can be operated with cooling air temperatures above 50°C by linearly de-rating the total maximum output power (or current) by 2.5%/°C from 50°C to 70°C (see figure 1).

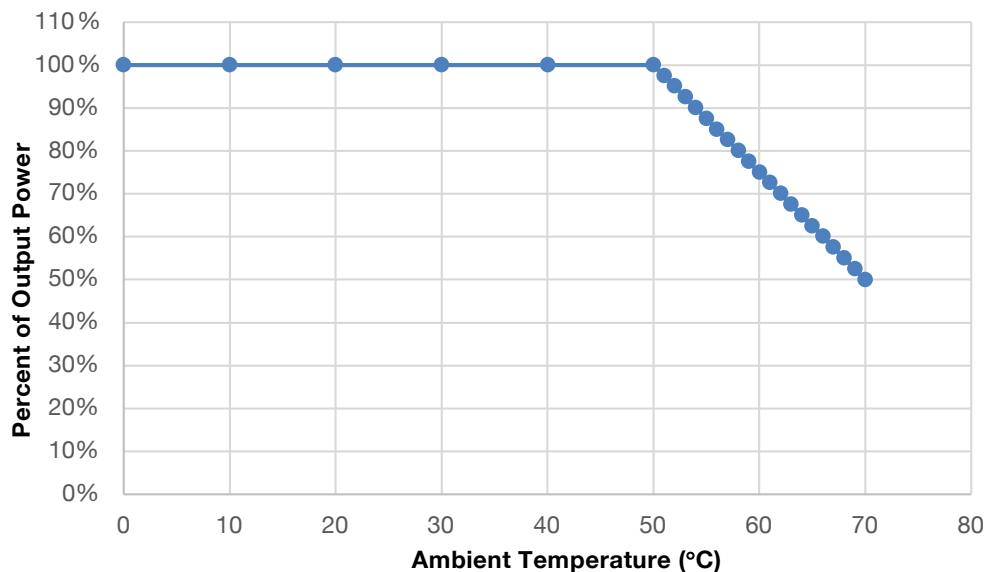

Figure 1

## 60 & 40 W, Efficient, Compact Non-Dimmable CV Class 2 / Class II LED Drivers

### 8 - PREDICTED LIFETIME VERSUS CASE AND AMBIENT TEMPERATURE

Lifetime is defined by the measurement of the temperatures of all the electrolytic capacitors whose failure would affect light output under the nominal LED load and worst case AC line voltage. The graphs in figures 2 and 3 are determined by the electrolytic capacitor with the shortest lifetime, among all electrolytic capacitors. It represents a worst case scenario in which the LED driver is powered 24 hours/day, 7 days/week. The lifetime of an electrolytic capacitor is measured when any of the following changes in performance are observed:

- 1) Capacitance changes more than 20% of initial value
- 2) Dissipation Factor ( $\tan \delta$ ): 150% or less of initial specified value
- 3) Equivalent Series Resistance (ESR): 150% or less of initial specified value
- 4) Leakage current: less of initial specified value

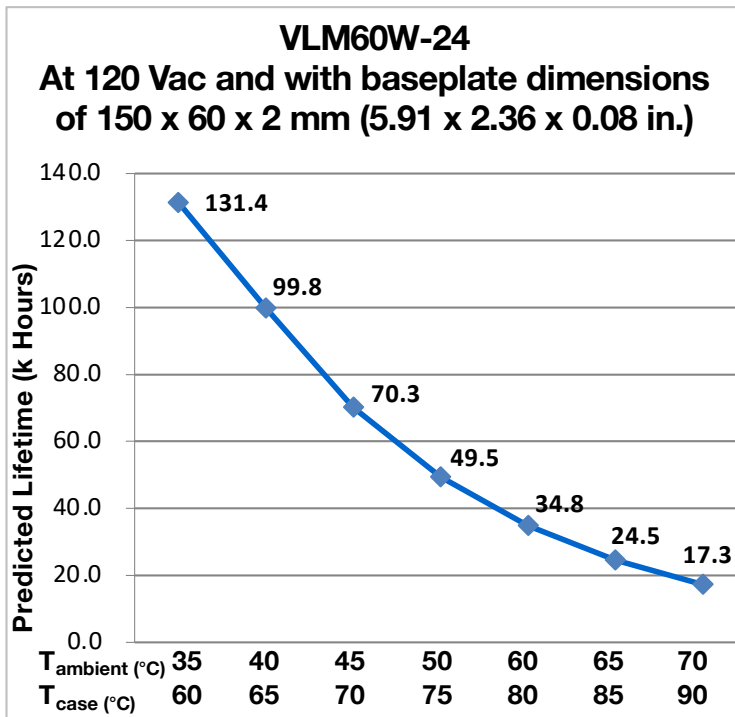

Figure 2

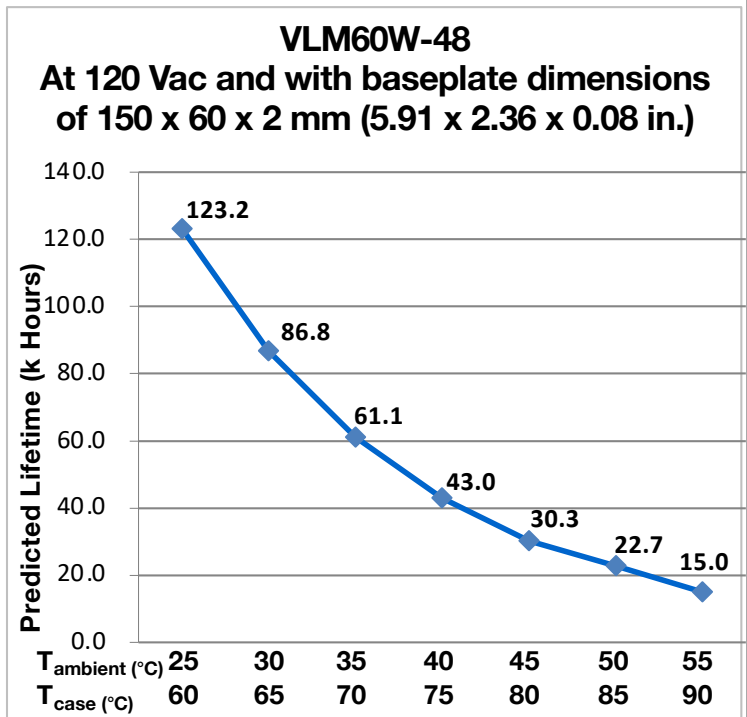

Figure 3

**Notes:**

- The ambient temperature  $T_{\text{ambient}}$  and the differential between  $T_{\text{ambient}}$  and  $T_{\text{case}}$  mentioned in the above graphs are relevant only as long as both the driver and the light fixture are exposed to the same ambient room temperature. If the LED driver is housed in an enclosure or covered by insulation material, then the ambient room temperature is no longer valid. In this situation, please refer only to the case temperature  $T_{\text{case}}$ .
- It should be noted the graph "Lifetime vs. Ambient Temperature" may have an error induced in the final application if the mounting has restricted convection flow around the case. For applications where this is evident, the actual case temperature measured at the  $T_c$  point in the application should be used for reliability calculations.



## 60 & 40 W, Efficient, Compact Non-Dimmable CV Class 2 / Class II LED Drivers

### 9 – EFFICIENCY VERSUS LOAD

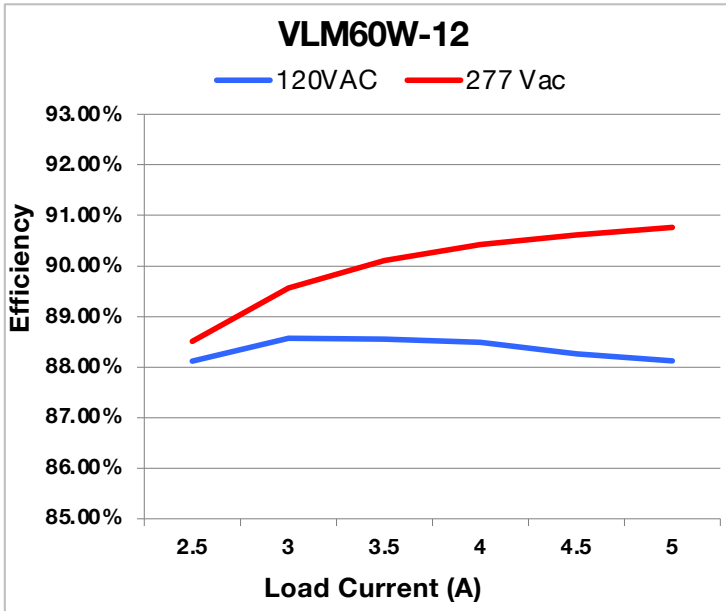

Figure 4

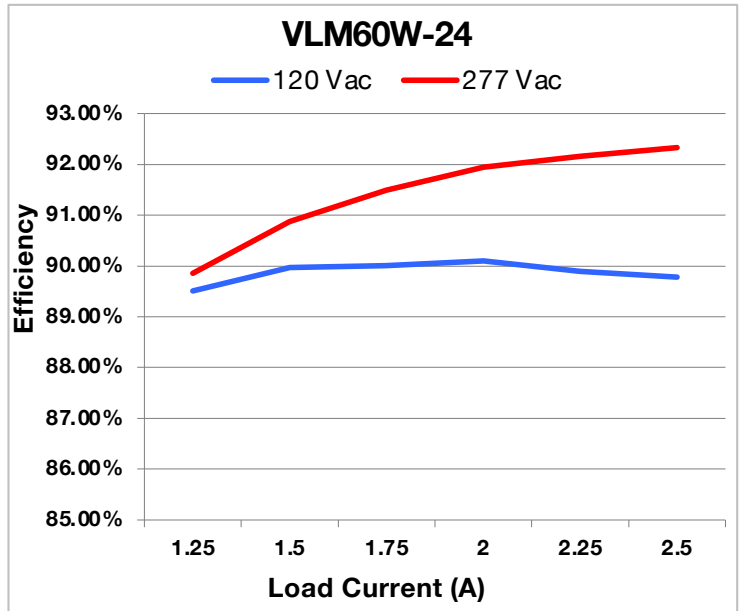

Figure 5

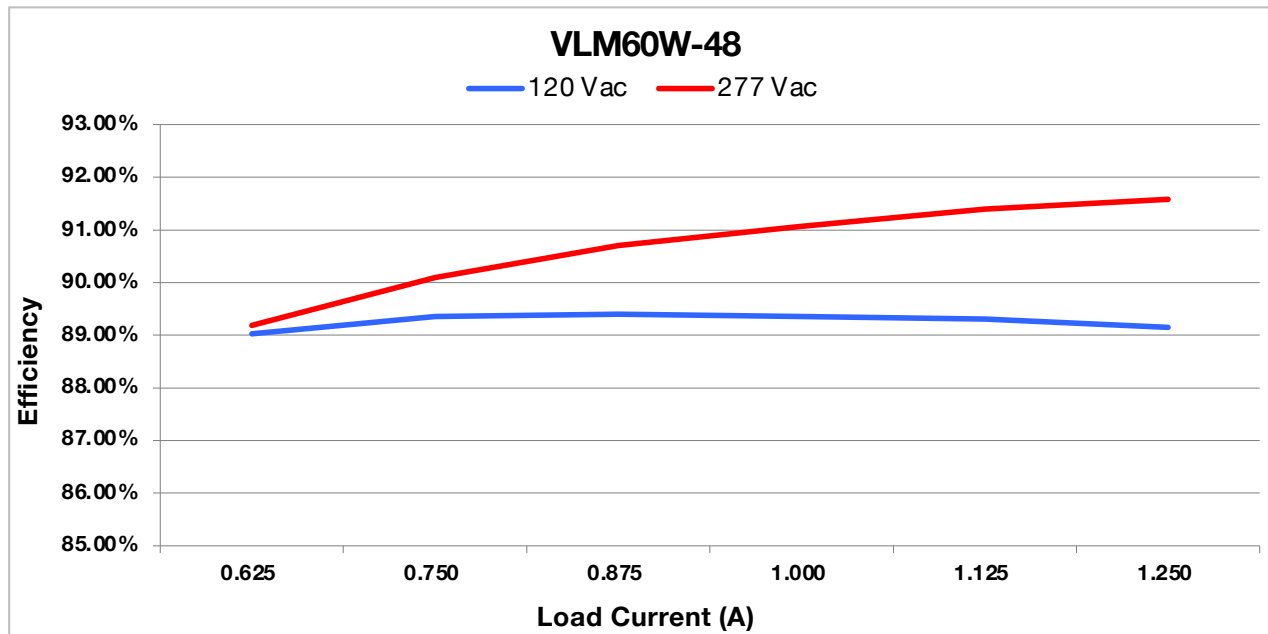

Figure 6

## 60 & 40 W, Efficient, Compact Non-Dimmable CV Class 2 / Class II LED Drivers

### 9 – EFFICIENCY VERSUS LOAD (CONTINUED)

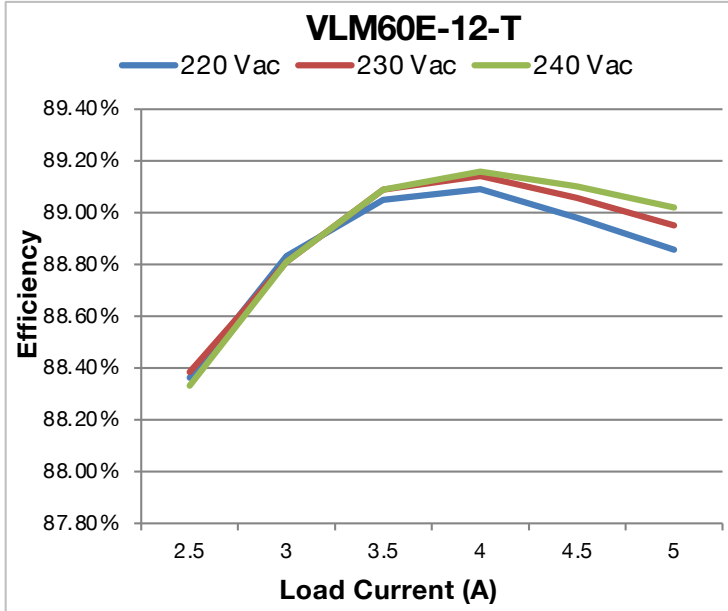

Figure 7

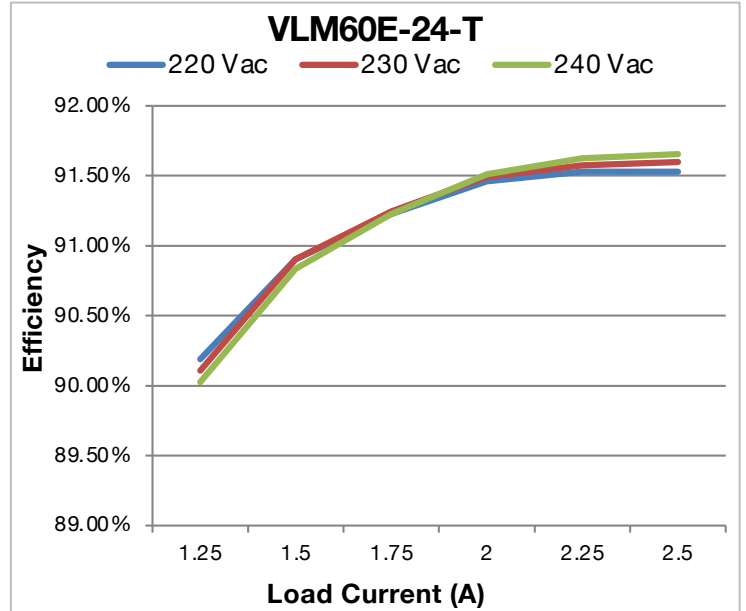

Figure 8

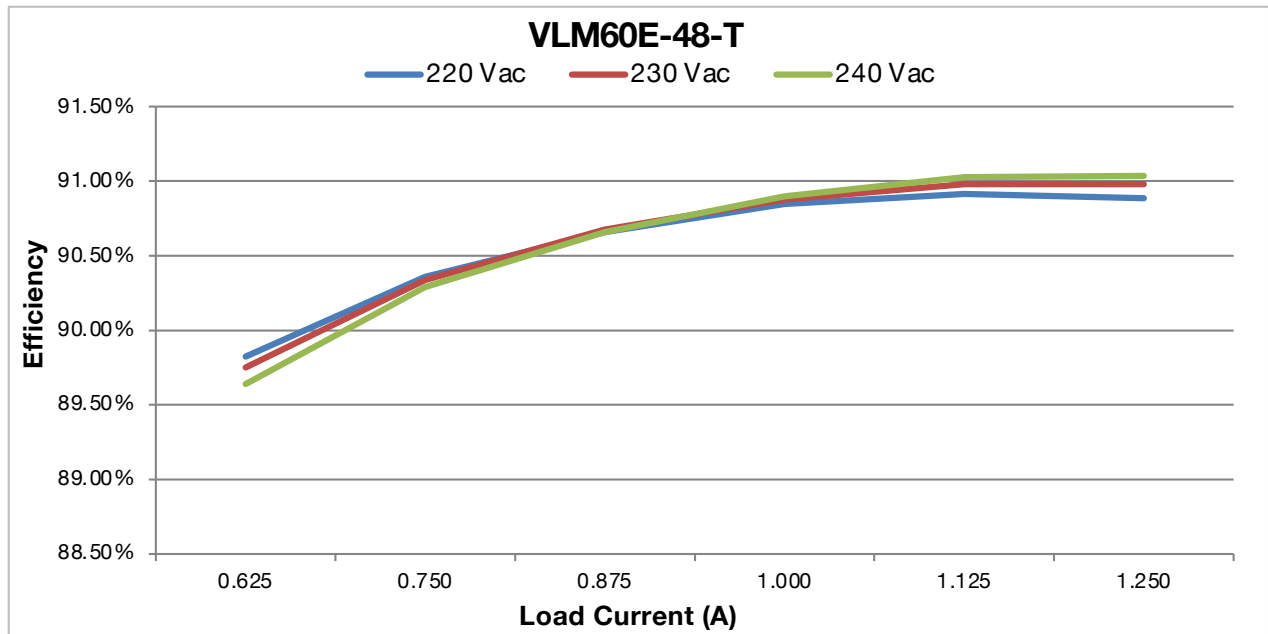

Figure 9



## 60 & 40 W, Efficient, Compact Non-Dimmable CV Class 2 / Class II LED Drivers

### 10 – POWER FACTOR VERSUS LOAD

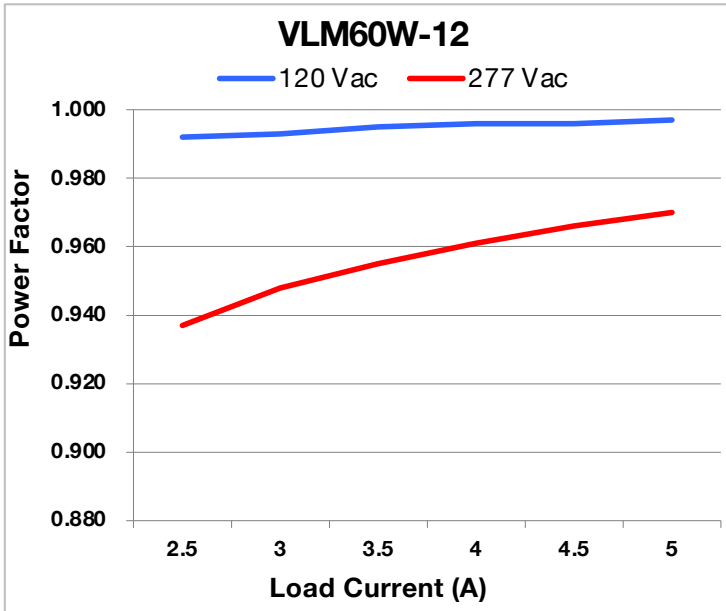

Figure 10

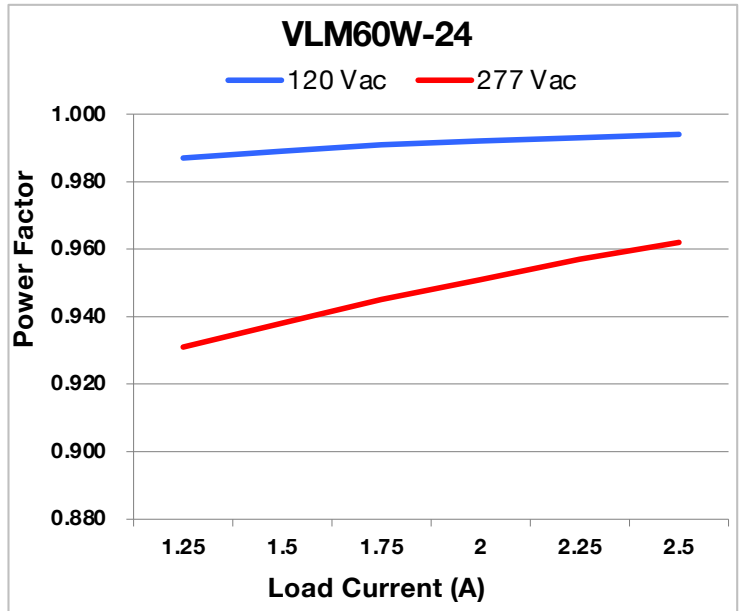

Figure 11

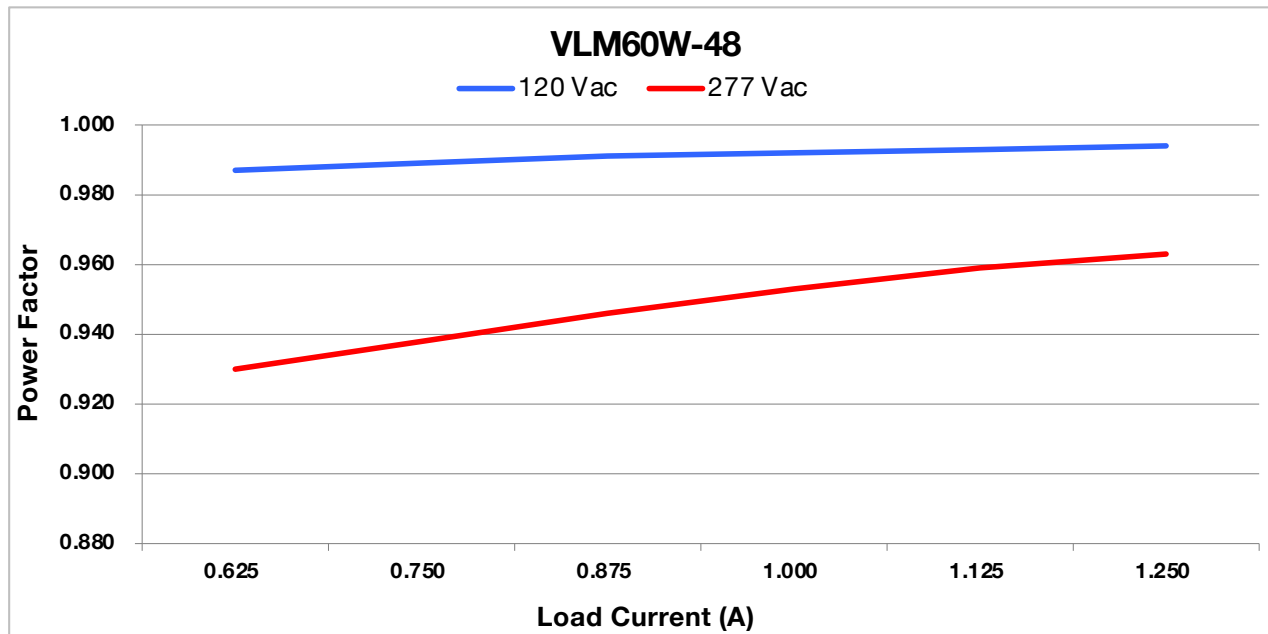

Figure 12

## 60 & 40 W, Efficient, Compact Non-Dimmable CV Class 2 / Class II LED Drivers

### 10 – POWER FACTOR VERSUS LOAD (CONTINUED)

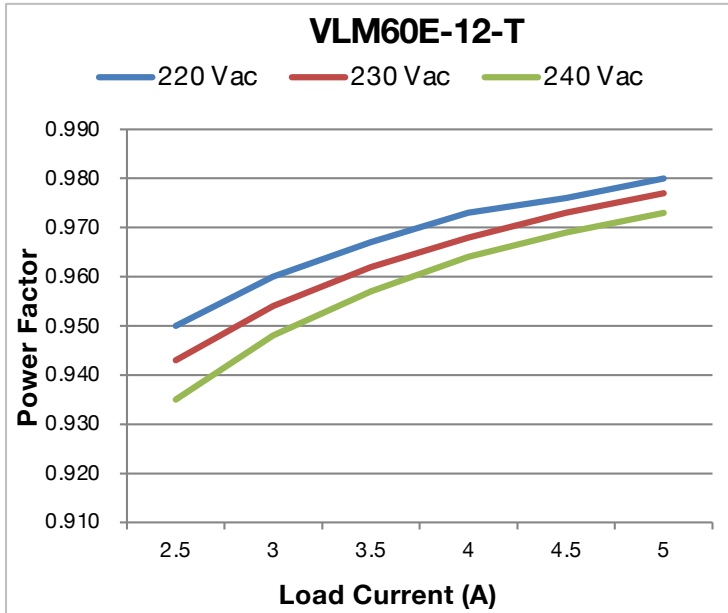

Figure 13

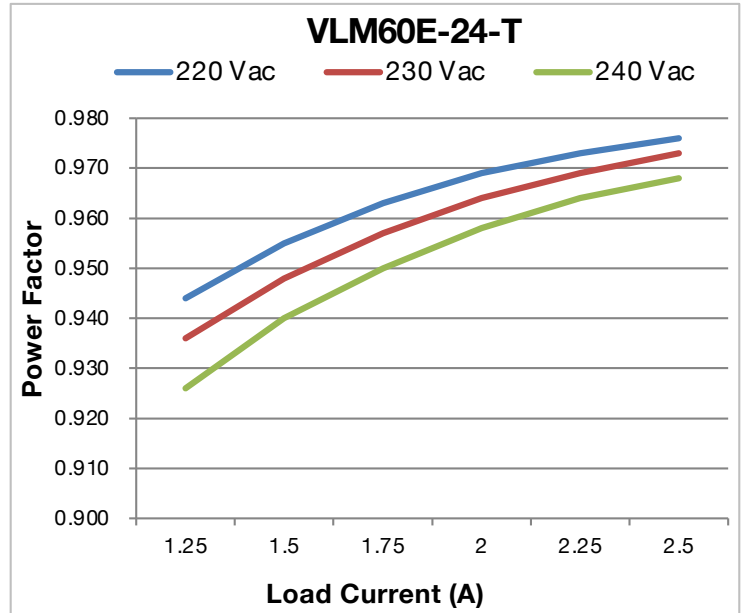

Figure 14

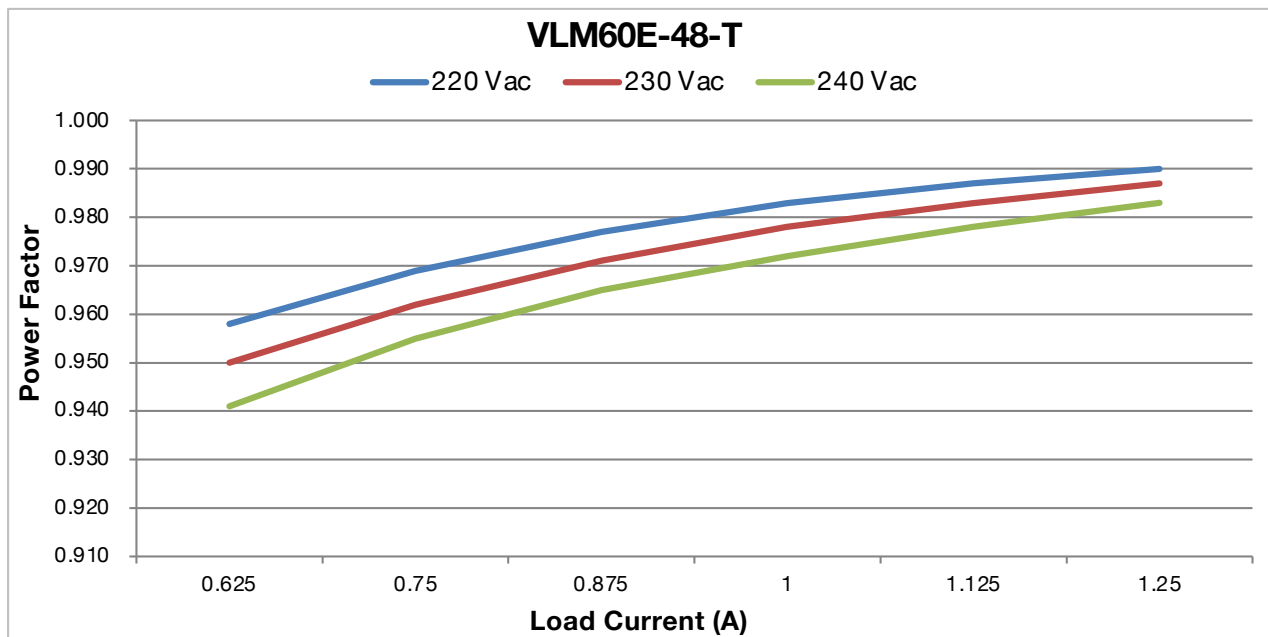

Figure 15

## 60 & 40 W, Efficient, Compact Non-Dimmable CV Class 2 / Class II LED Drivers

### 11 – THD VERSUS LOAD

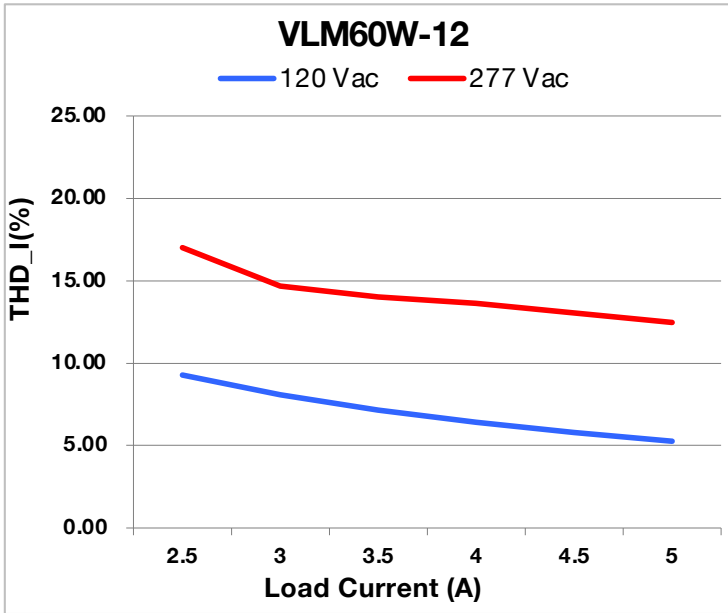

Figure 16

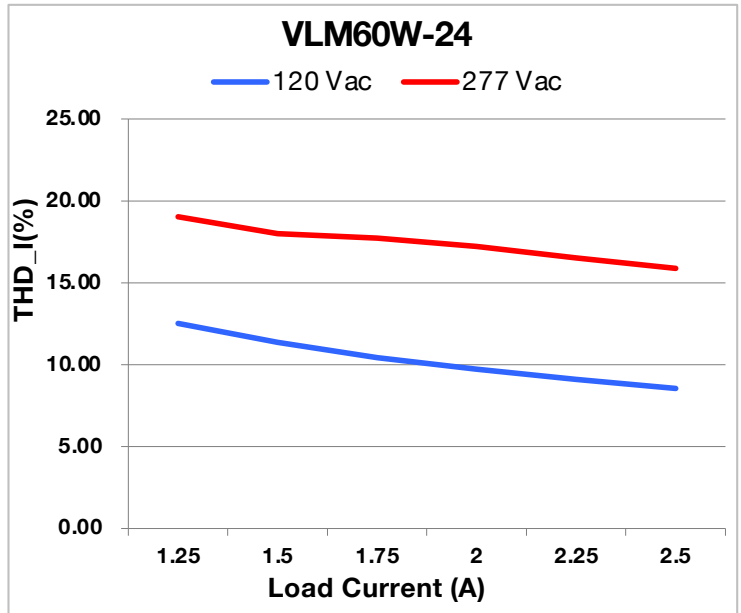

Figure 17

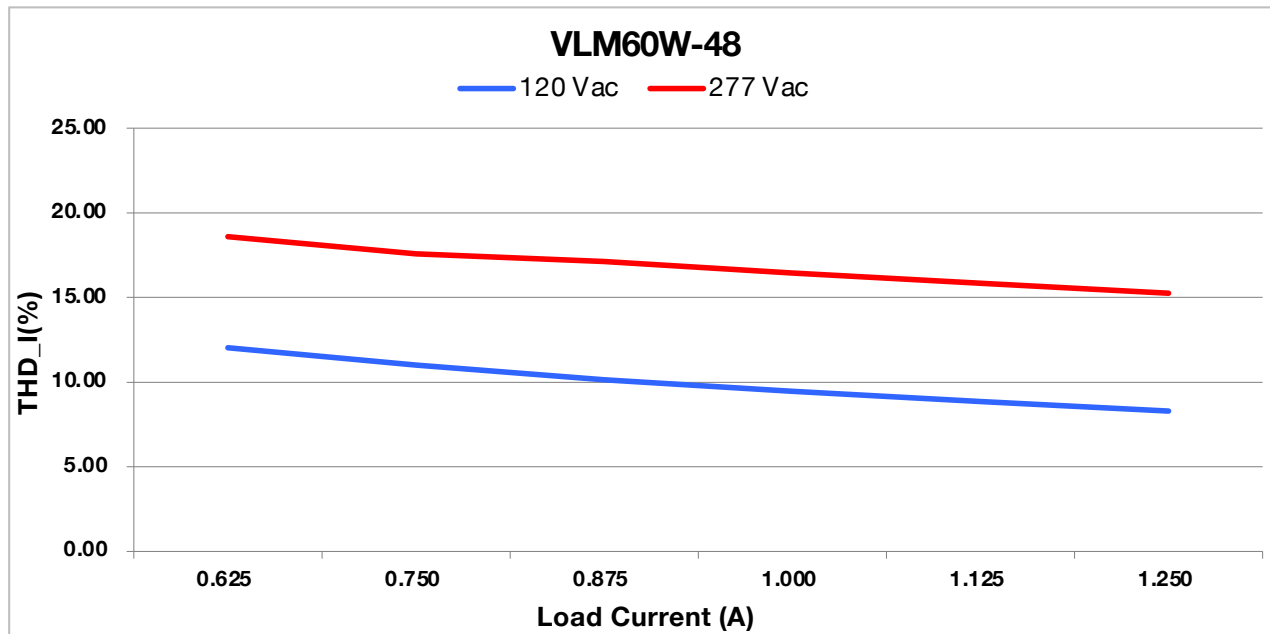

Figure 18

## 60 & 40 W, Efficient, Compact Non-Dimmable CV Class 2 / Class II LED Drivers

### 11 – THD VERSUS LOAD (CONTINUED)

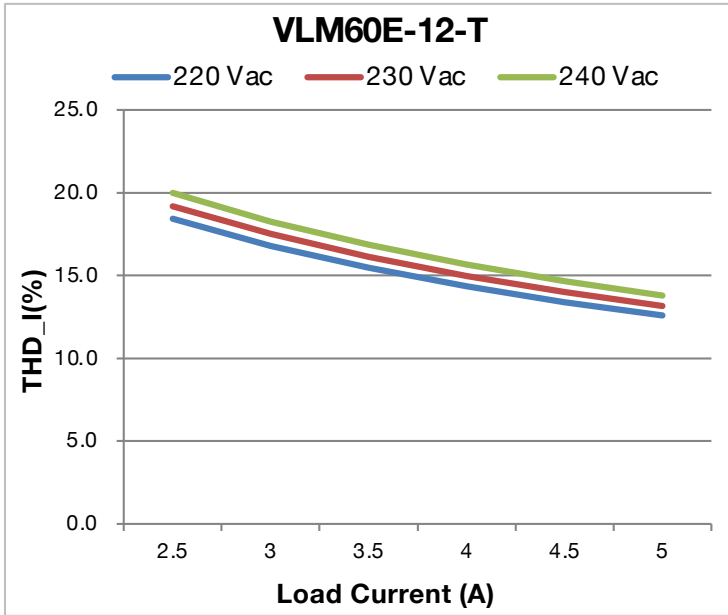

Figure 19

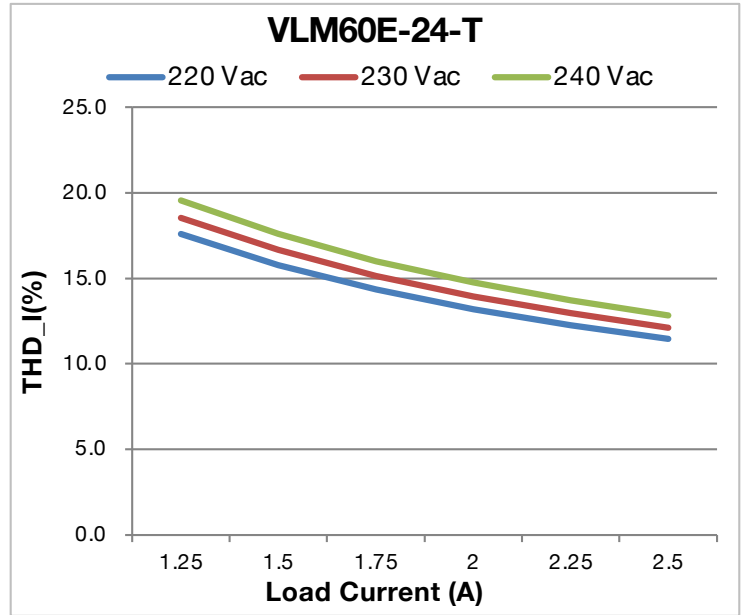

Figure 20

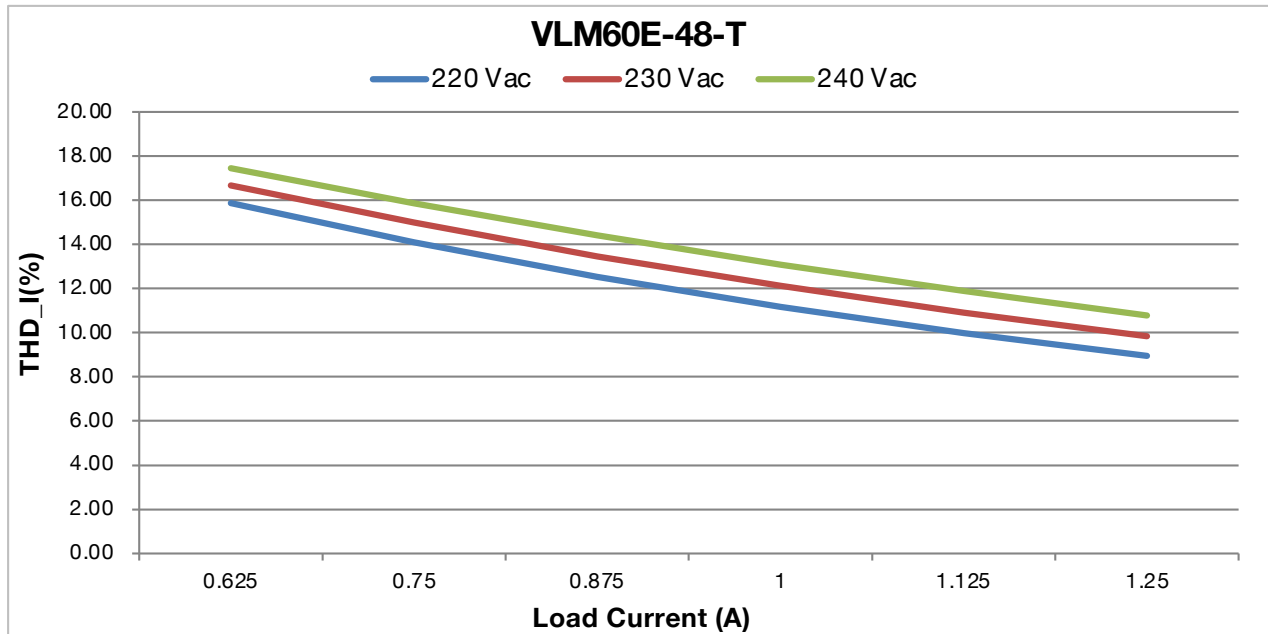

Figure 21

## 60 & 40 W, Efficient, Compact Non-Dimmable CV Class 2 / Class II LED Drivers

### 12 - MECHANICAL DETAILS

- **Packaging Options:** Aluminum case
- **I/O Connections:**
  - **Models with flying leads:** 18 AWG on all leads, 203mm (8 in) long, 105°C rated, stranded, stripped by approximately 9.5 mm, and tinned. All the wires, on both input and output, have a 300 V insulation rating.
  - **Models with “S” suffix:** Terminal blocks
  - **Models with “T” suffix:** Terminal blocks
- **Ingress Protection:** IP20 rated
- **Mounting Instructions:** The VLM60/40 driver case must be secured on a flat surface through the two mounting tabs, shown here below in the case outline drawings. We recommended mounting the VLM60/40 on a baseplate with dimensions of 150 x 60 x 2 mm (5.91 x 2.36 x 0.08 in).

### 13 - OUTLINE DRAWINGS (VLMXXW MODELS WITH FLYING LEADS)

**Dimensions:** L 130.0 x W 19.65 x H 19.8 mm (L 5.12 x W 0.77 x H 0.78 in)  
**Weight:** 119 g (4.20 oz)

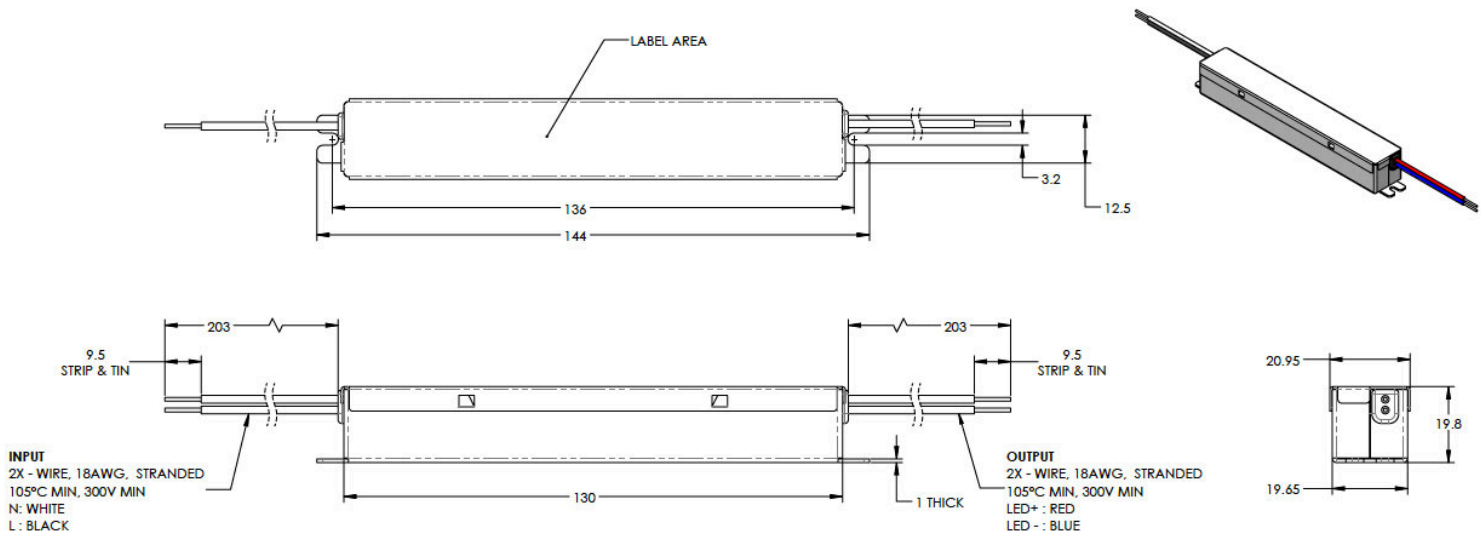

All dimensions are in mm

**Figure 22**

## 60 & 40 W, Efficient, Compact Non-Dimmable CV Class 2 / Class II LED Drivers

### 14 - OUTLINE DRAWINGS (VLMXXE MODELS WITH FLYING LEADS)

**Dimensions:** L 141 x W 19.7 x H 19.8 mm (L 5.55 x W 0.78 x H 0.78 in)

**Weight:** 122 g (4.30 oz)

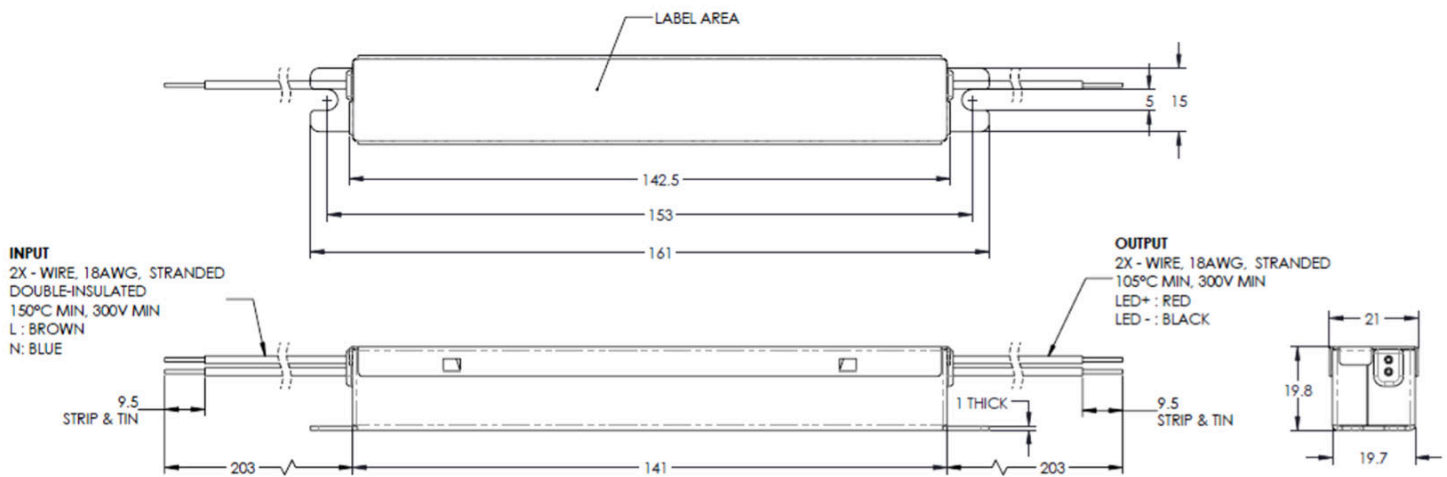

All dimensions are in mm

**Figure 23**

## 60 & 40 W, Efficient, Compact Non-Dimmable CV Class 2 / Class II LED Drivers

### 15 - OUTLINE DRAWINGS (MODELS WITH "-T" SUFFIX: TERMINAL BLOCKS)

**Dimensions:** L 183.2 x W 19.9 x H 19.85 mm (L 8.03 x W 0.78 x H 0.78 in)  
**Weight:** 127 g (4.48 oz)

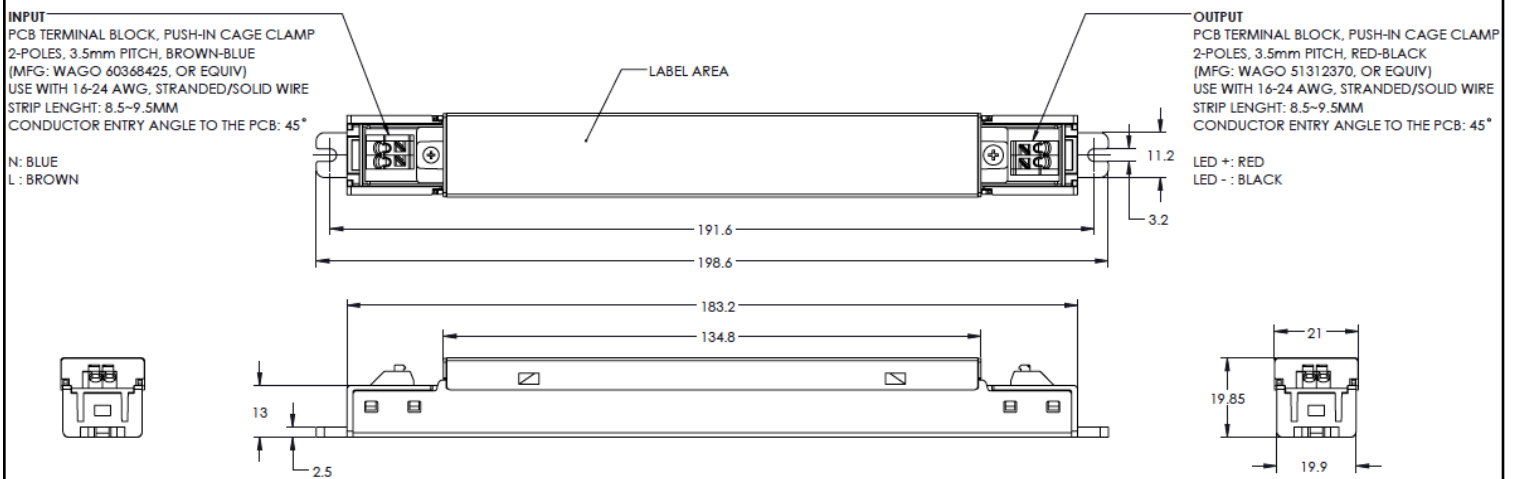

All dimensions are in mm

**Figure 24**



## 60 & 40 W, Efficient, Compact Non-Dimmable CV Class 2 / Class II LED Drivers

### 16 - OUTLINE DRAWINGS (MODELS WITH "-T" SUFFIX AND STRAIN RELIEFS)

**Dimensions:** L 241.6 x W 19.9 x H 19.85 mm (L 9.51 x W 0.78 x H 0.78 in)

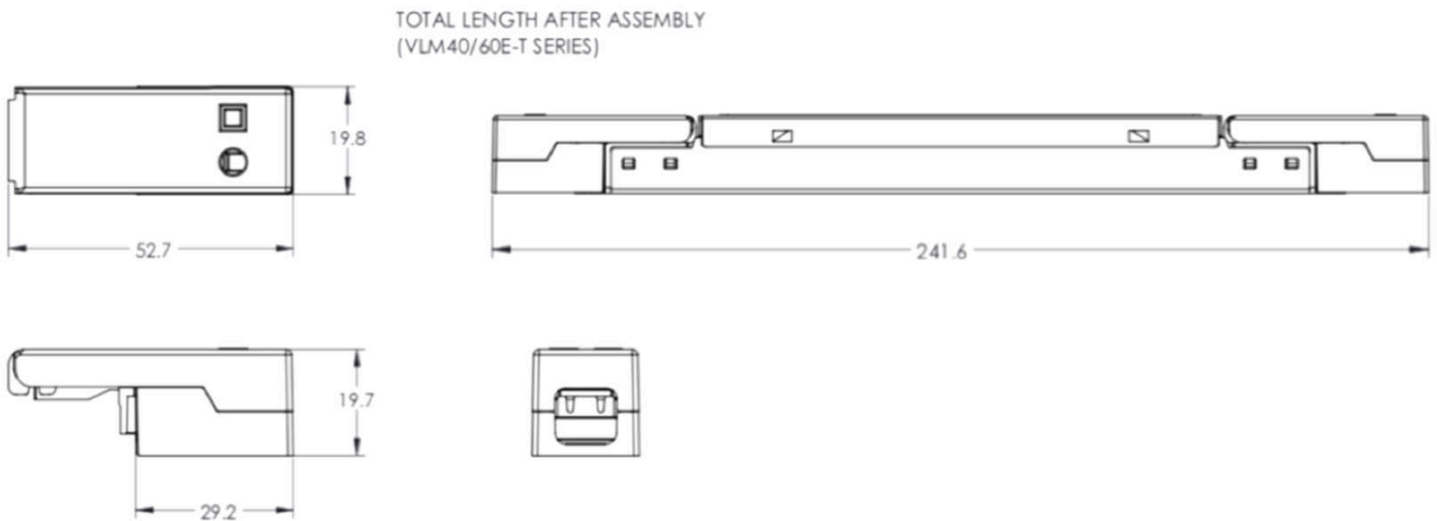

All dimensions are in mm

**Figure 25**

**Notes:**

1. Strain reliefs for "-T" models are not included and can be ordered separately using part number SR1.
2. Strain reliefs allow the driver to operate as independent control gear. This designation allows the driver to be mounted outside of the luminaire. Without strain reliefs the driver must be mounted inside the luminaire.
3. Order quantity for SR1 is per strain relief, and 2 strain reliefs are needed for each driver.
4. Additional information regarding strain reliefs can be found under the accessories section on the ERP website.

## 60 & 40 W, Efficient, Compact Non-Dimmable CV Class 2 / Class II LED Drivers

17 - OUTLINE DRAWINGS (MODELS WITH "-S" SUFFIX: BOTTOM LEADS AND STUDS)

**Dimensions:** L 130 x W 19.65 x H 23.85 mm (L 5.12 x W 0.77 x H 0.94 in)

**Weight:** 142 g (5.01 oz)

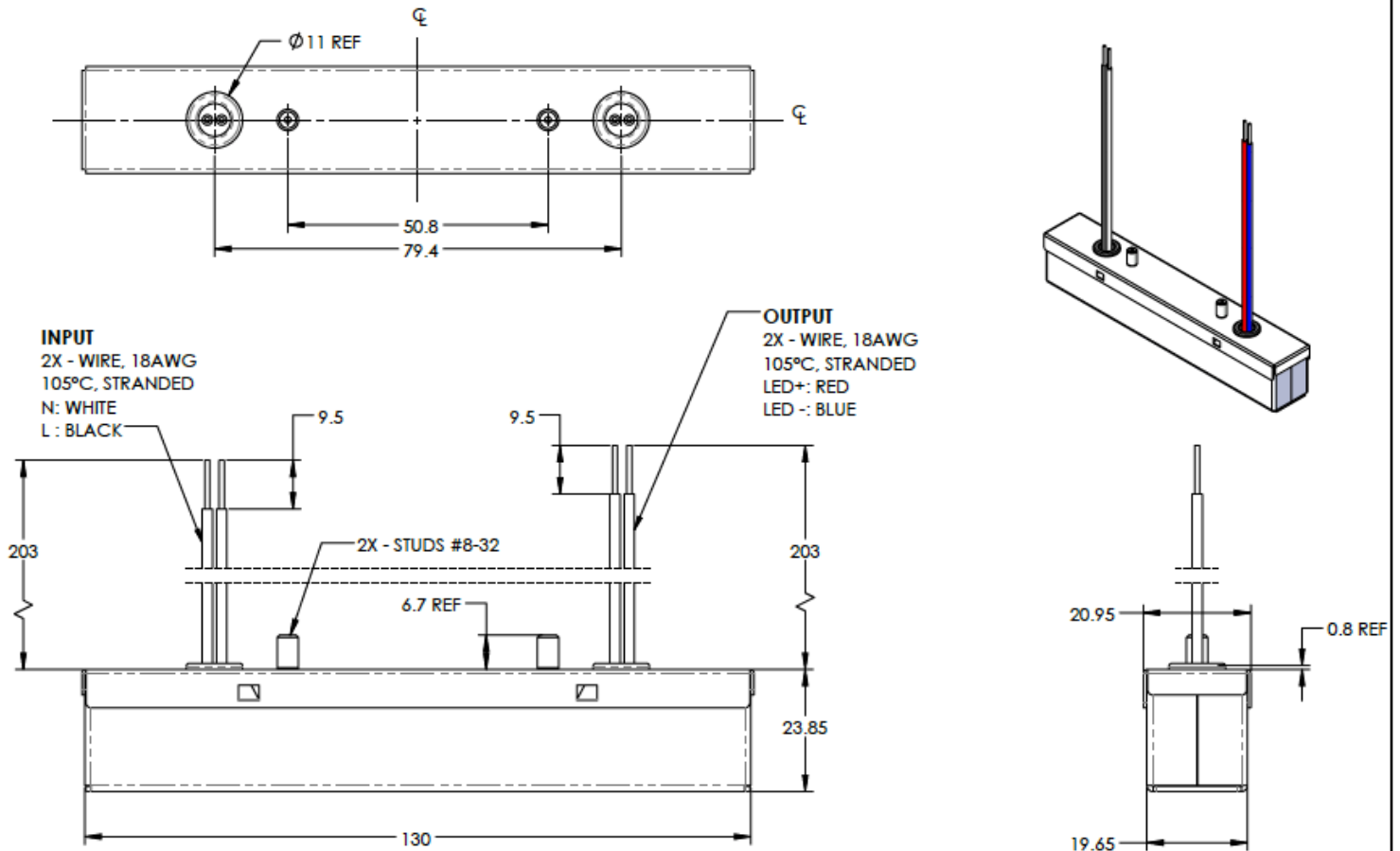

All dimensions are in mm

Figure 26



# VLM60/40 Series

**VLM60 60 W**  
**VLM40 40 W**

## 60 & 40 W, Efficient, Compact Non-Dimmable CV Class 2 / Class II LED Drivers

### 18 - LABELING

The VLM60W-24 and VLM60E-24-T are used in figure 27 as examples to illustrate typical labels.

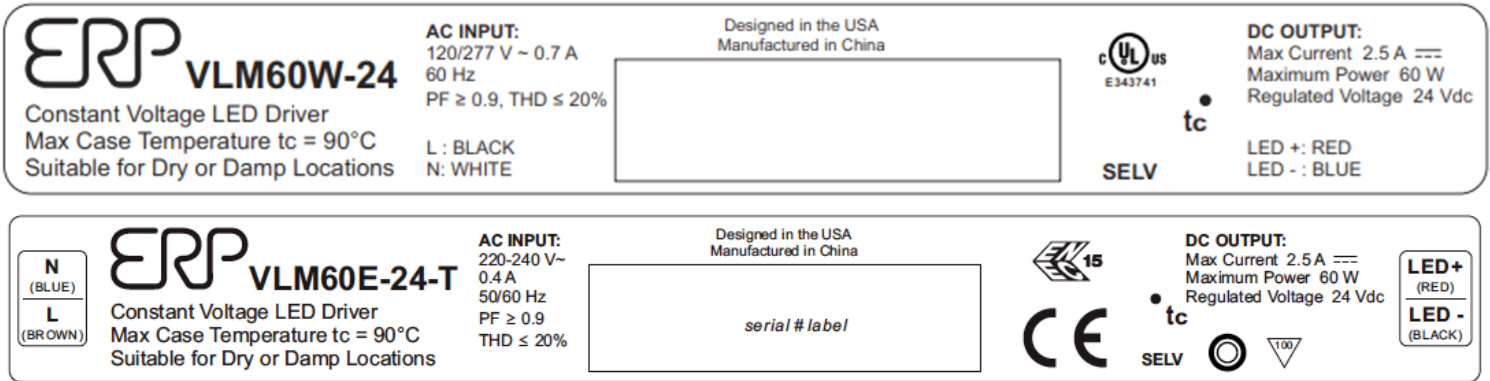

Figure 27

**USA Headquarters**  
Tel: +1-805-517-1300  
Fax: +1-805-517-1411  
893 Patriot Drive, Suite E,  
Moorpark, CA 93021, USA

**CHINA Operations**  
Tel: +86-756-6266298  
Fax: +86-756-6266299  
No. 8 Pingdong Road 2  
Zhuhai, Guangdong, China 519060

ERP Power, LLC (ERP) reserves the right to make changes without further notice to any products herein. ERP makes no warranty, representation or guarantee regarding the suitability of its products for any particular purpose, nor does ERP assume any liability arising out of the application or use of any product or circuit, and specifically disclaims any and all liability, including without limitation special, consequential or incidental damages. "Typical" parameters which may be provided in ERP data sheets and/or specifications can and do vary in different applications and actual performance may vary over time. All operating parameters, including "Typicals" must be validated for each customer application by customer's technical experts. ERP does not convey any license under its patent rights nor the rights of others. ERP products are not designed, intended, or authorized for use as components in systems intended for surgical implant into the body, or other applications intended to support or sustain life, or for any other application in which the failure of the ERP product could create a situation where personal injury or death may occur. Should Buyer purchase or use ERP products for any such unintended or unauthorized application, Buyer shall indemnify and hold ERP and its officers, employees, subsidiaries, affiliates, and distributors harmless against all claims, costs, damages, and expenses, and reasonable attorney fees arising out of, directly or indirectly, any claim of personal injury or death associated with such unintended or unauthorized use, even if such claim alleges that ERP was negligent regarding the design or manufacture of the part. ERP is an Equal Opportunity/Affirmative Action Employer. This literature is subject to all applicable copyright laws and is not for resale in any manner.



# VLM60/40 Series

**VLM60** 60 W  
**VLM40** 40 W

## 60 & 40 W, Efficient, Compact Non-Dimmable CV Class 2 / Class II LED Drivers

### Revision History

| Date      | Comments   |
|-----------|--|
| 12FEB2019 | <ul style="list-style-type: none"> <li>• Pg1: changed render files to stamped case</li> <li>• Added 3 pages, VLMXXE characterization curves</li> <li>• Pg10-13: changed MCO to stamped case</li> </ul> |
| 20MAR2019 | <ul style="list-style-type: none"> <li>• Pg2: added strain relief order info</li> <li>• Pg15: added strain relief order info</li> </ul>  |
| 09APR2019 | <ul style="list-style-type: none"> <li>• Added euro flying leads MCO</li> <li>• Added weights</li> </ul>   |
| 29OCT2019 | <ul style="list-style-type: none"> <li>• Pg2: added compliance column</li> </ul>   |
| 09DEC2019 | <ul style="list-style-type: none"> <li>• Pg2: removed models</li> </ul>  |
| 10MAR2020 | <ul style="list-style-type: none"> <li>• Pg18: updated label image</li> </ul>  |
| 23APR2020 | <ul style="list-style-type: none"> <li>• Pg2: added strain relief information</li> <li>• Pg16: added additional strain relief information</li> </ul>   |
| 30JUL2020 | <ul style="list-style-type: none"> <li>• Pg1: added statement regarding VLM use</li> <li>• Pg3: added max number of units per circuit breaker</li> </ul>   |
| 21SEP2020 | <ul style="list-style-type: none"> <li>• Various grammar changes</li> </ul>  |
|           |  |
|           |  |
|           |  |
|           |  |
|           |  |
|           |  |
|           |  |
|           |  |
|           |  |
|           |  |
|           |  |